



I/O Connectors



C B O 12. 4 -2 - C B 12. 4 / P

Special Function and Cable Material

Null: PVC
P: PUR
WS: Shielded
L: PNP LED
LN: NPN LED
EWSR: Welding spark resistance

No. of Pin

3: 3-pin
4: 4-pin
5: 5-pin
8: 8-pin

Size

8: M8*1 12: M12*1

Shape

Null: Straight B: Angled

Product Category

C-type Q-type

Specification

Null: Single pre-wired

Cable length

Standard: 2m

No. of Pin

2: 2-pin(2.2, 2.21, 2.22 different pin sequence)
3: 3-pin
4: 4-pin
5: 5-pin
8: 8-pin

Size

8: M8*1 12: M12*1

Gender

Null: Male O: Female

Shape

Null: Straight B: Angled

Product Category

C-type Q-type

**Cordsets
Order Code**

ECS - F E 2 C B . 12 . 4 - 2/2 / .

Special Function and Cable Material

Null: PVC
 P: PUR
 WS: Shielded
 L: PNP LED
 LN: NPN LED
 B24: 2-, 4-pin shorted

Connection Type (splitter)

2/2: 2m cable for each end
 2-C12.4: Male straight M12 connector with 2m cable
 2-C8.4: Male straight M8 connector with 2m cable
 2-CB12.4: Male angled M12 connector with 2m cable
 2-CB8.4: Male angled M8 connector with 2m cable

No. of Pin

2: 2-pin(2.2, 2.21, 2.22 different pin sequence)
 3: 3-pin
 4: 4-pin
 5: 5-pin

Connection Type (adapter)

Null: Homerun cable
 8: M8*1 12: M12*1

Gender

Null: Male O: Female

Shape

Null: Straight B: Angled

Specification

Null: Homerun cable VC: Pre-wired connector

Product Category

Null: Y adapter 2: Y splitter

Size

Null: M12 E: M8

Gender

Null: Male F: Female

Product Category

Y splitter/adapter

**Y Splitter/Adapter
 Order Code**

Pre-Wired I/O Connectors

The pre-wired and plastic I/O connectors meet all requirements for safe, fast and reliable field connections. Our standardized pre-wired connectors guarantee steady and shock prove IP67 connections. Depending on the selected cable type, they cover all applications in difficult environmental conditions like chemical influences, high or low air temperatures and significant mechanical stress. Cables are available with screening shields to ensure secure and interference-free signal transmissions.

- Shock resistant, reliable contact
- 360° shielded connectors
- Protection class IP67
- Current rating 2-4 A (depends on number of cores)
- Optional 2, 3, 4, 5, 8 core cables available
- Various cable types:
 - PVC, PUR, with or without shields, EWSR spark resistant
 - STPE high elastic and high flexible
- Oil and chemical resistant, flame retardant, drag chain suitable
- Connectors M8x1, M12x1, 7/8", M23x1 threads
- Optional straight and angled connectors
- Built in LED indicators
- Optional A-coded, B-coded etc. interface
- Standard cable lengths 2m, all other lengths optionally available
- Special cables for special applications available on request



Y Splitter/Adapter

Y Splitter/Adapter includes different types of products, such as module type and cable output type. It can be used as simple distribution box and extended port access to reduce installation cost and save installation time. The material and structure of Y splitter/adapter are available in dirty and damp industrial environment and its protection class is up to IP67.

Y splitter/adapter including M12 to 2×M12, M12 to 2×M8, M8 to 2×M12, M8 to 2×M8 and M8/M12 to homerun cable with customized length. It can be used for port extension, distribution box kit and distributed I/O connector extension.



I/O Cable

PVC Cable /

The cable with PVC jacket and its good mechanical performance (e.g. tensile strength, crack and abrasion resistance) is suitable for most applications in industrial installations. The cable is weatherproof and resistant to oil and chemical solutions. It is therefore a standard and economic solution for field installations to link I/O systems.

EWSR Cable /

The special jacket material can enhance the mechanical properties (including tensile strength, crack resistance and wear resistance) and has high temperature resistance. Once you choose this cable, the detailed field environment and requirements must be clear.





















PUR Cable /

The PUR jacket cable with its superior mechanical performance (e.g. tensile strength, crack and abrasion resistance, weather and oil/chemical resistance) is suitable for applications in extreme environments. It is therefore an ideal solution for industrial installations to link I/O systems in a harsh environment.

Shielding Cable /

The tinned copper braid shielding layer provides a good electromagnetic shield against interferences. Shielded cables therefore improve safe signal transmissions. A wide range of special cables for special applications are available upon request. Please contact us to discuss your exact requirements.

Pin Assignment

	2pin			3pin	4pin	5pin	8pin
	2.2	2.21	2.22				
M8 Female				4BK 3BU  1BN	4BK 2WH 3BU  1BN	5GY 3BU  1BN 4BK 2WH	
M8 Male				4BK 1BN  3BU	2WH 4BK 1BN  3BU	5GY 3BU  1BN 4BK 2WH	
M12 Female	1BN  4BU	2BU 1BN 	 3BN 4BU	2 1BN  3BU 4BK	2WH 1BN  3BU 4BK	2WH 1BN  3BU 5GY 4BK	
M12 Male	 1BN 4BU	2 BU  1BN	3BN  4BU	2 3BU  1BN 4BK	2WH 3BU  1BN 4BK	2WH 5GY 3BU  1BN 4BK	

Dimensions M8

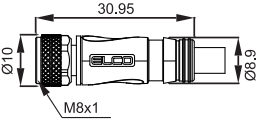
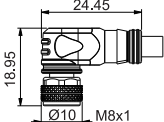
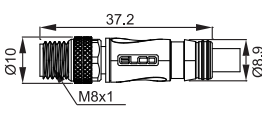
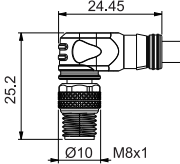
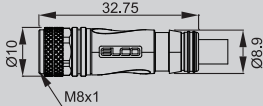
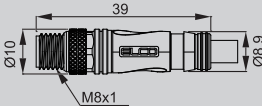
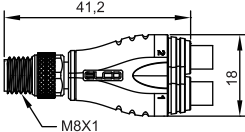
	Straight Female	Angled Female	Straight Male	Angled Male
Standard				
Special Application				
Y-Splitter				

Dimensions M12

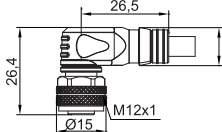
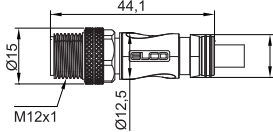
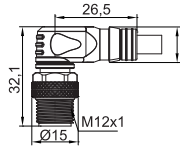
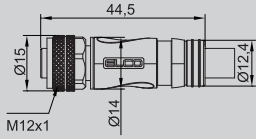
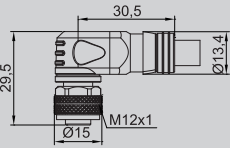
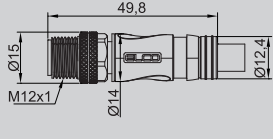
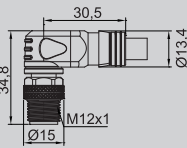
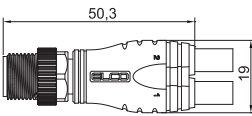
	Straight Female	Angled Female	Straight Male	Angled Male
Standard				
Special Application				
Y-Splitter				



I/O

Connectors

M8

Single-ended I/O Cordsets-M8 (Straight-female)

Type Code						
Cable jacket	Description	Type	Pin	Rated current/voltage	Cable length	Wire section
 PVC	Female 3-core	CO8.3-2	3	4A/60V	2m	0.25mm ²
	Female 4-core	CO8.4-2	4	4A/30V	2m	0.25mm ²
	Female 3-core PNP	CO8.3-2/L	3	4A/30V	2m	0.25mm ²
	Female 3-core NPN	CO8.3-2/LN	3	4A/30V	2m	0.25mm ²
	Female 4-core PNP	CO8.4-2/L	4	4A/30V	2m	0.25mm ²
	Female 4-core NPN	CO8.4-2/LN	4	4A/30V	2m	0.25mm ²
PUR	Female 3-core	CO8.3-2/P	3	4A/60V	2m	0.25mm ²
	Female 4-core	CO8.4-2/P	4	4A/30V	2m	0.25mm ²
	Female 3-core PNP	CO8.3-2/L/P	3	4A/30V	2m	0.25mm ²
	Female 3-core NPN	CO8.3-2/LN/P	3	4A/30V	2m	0.25mm ²
	Female 4-core PNP	CO8.4-2/L/P	4	4A/30V	2m	0.25mm ²
	Female 4-core NPN	CO8.4-2/LN/P	4	4A/30V	2m	0.25mm ²
PVC Shielded	Female 3-core	CO8.3-2/WS	3	4A/60V	2m	0.25mm ²
	Female 4-core	CO8.4-2/WS	4	4A/30V	2m	0.25mm ²
PUR Shielded	Female 3-core	CO8.3-2/WSP	3	4A/60V	2m	0.25mm ²
	Female 4-core	CO8.4-2/WSP	4	4A/30V	2m	0.25mm ²

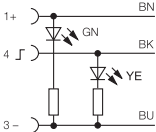
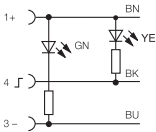
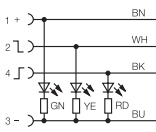
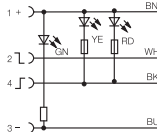
Product with LED	PNP 3-core	NPN 3-core	PNP 4-core	NPN 4-core
				

Single-ended I/O Cordsets-M8 (Straight-male)

Type Code							
	Cable jacket	Description	Type	Pin	Rated current/voltage	Cable length	Wire section
	PVC	Male 3-core	C8.3-2	3	4A/60V	2m	0.25mm ²
		Male 4-core	C8.4-2	4	4A/30V	2m	0.25mm ²
	PUR	Male 3-core	C8.3-2/P	3	4A/60V	2m	0.25mm ²
		Male 4-core	C8.4-2/P	4	4A/30V	2m	0.25mm ²
	PVC Shielded	Male 3-core	C8.3-2/WS	3	4A/60V	2m	0.25mm ²
		Male 4-core	C8.4-2/WS	4	4A/30V	2m	0.25mm ²
	PUR Shielded	Male 3-core	C8.3-2/WS/P	3	4A/60V	2m	0.25mm ²
		Male 4-core	C8.4-2/WS/P	4	4A/30V	2m	0.25mm ²

Single-ended I/O Cordsets-M8 (Angled-female)

Type Code						
Cable jacket	Description	Type	Pin	Rated current/voltage	Cable length	Wire section
	Female 3-core	CBO8.3-2	3	4A/60V	2m	0.25mm ²
	Female 4-core	CBO8.4-2	4	4A/30V	2m	0.25mm ²
	Female 3-core PNP	CBO8.3-2/L	3	4A/30V	2m	0.25mm ²
	Female 3-core NPN	CBO8.3-2/LN	3	4A/30V	2m	0.25mm ²
	Female 4-core PNP	CBO8.4-2/L	4	4A/30V	2m	0.25mm ²
	Female 4-core NPN	CBO8.4-2/LN	4	4A/30V	2m	0.25mm ²
PUR	Female 3-core	CBO8.3-2/P	3	4A/60V	2m	0.25mm ²
	Female 4-core	CBO8.4-2/P	4	4A/30V	2m	0.25mm ²
	Female 3-core PNP	CBO8.3-2/L/P	3	4A/30V	2m	0.25mm ²
	Female 3-core NPN	CBO8.3-2/LN/P	3	4A/30V	2m	0.25mm ²
	Female 4-core PNP	CBO8.4-2/L/P	4	4A/30V	2m	0.25mm ²
	Female 4-core NPN	CBO8.4-2/LN/P	4	4A/30V	2m	0.25mm ²
PVC Shielded	Female 3-core	CBO8.3-2/WS	3	4A/60V	2m	0.25mm ²
	Female 4-core	CBO8.4-2/WS	4	4A/60V	2m	0.25mm ²
PUR Shielded	Female 3-core	CBO8.3-2/WS/P	3	4A/60V	2m	0.25mm ²
	Female 4-core	CBO8.4-2/WS/P	4	4A/60V	2m	0.25mm ²

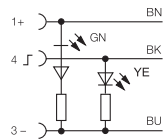
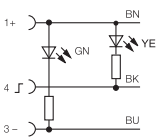
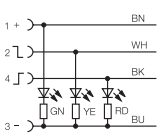
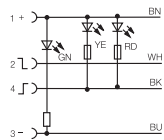
Product with LED	PNP 3-core	NPN 3-core	PNP 4-core	NPN 4-core
				



Single-ended I/O Cordsets-M8 (Angled-male)

Type Code							
	Cable jacket	Description	Type	Pin	Rated current/voltage	Cable length	Wire section
	PVC	Male 3-core	CB8.3-2	3	4A/60V	2m	0.25mm ²
		Male 4-core	CB8.4-2	4	4A/30V	2m	0.25mm ²
	PUR	Male 3-core	CB8.3-2/P	3	4A/60V	2m	0.25mm ²
		Male 4-core	CB8.4-2/P	4	4A/30V	2m	0.25mm ²
	PVC Shielded	Male 3-core	CB8.3-2/WS	3	4A/60V	2m	0.25mm ²
		Male 4-core	CB8.4-2/WS	4	4A/30V	2m	0.25mm ²
	PUR Shielded	Male 3-core	CB8.3-2/WS/P	3	4A/60V	2m	0.25mm ²
		Male 4-core	CB8.4-2/WS/P	4	4A/30V	2m	0.25mm ²



Double-ended I/O Connector-M8 (female) to M8 (male)

Type Code							
	Cable jacket	Description	Type	Pin	Rated current/voltage	Cable length	Wire section
	PVC	3-core straight to straight	CO8.3-2-C8.3	3	4A/60V	2m	0.25mm ²
		3-core straight to angled	CO8.3-2-CB8.3	3	4A/60V	2m	0.25mm ²
		4-core straight to straight	CO8.4-2-C8.4	4	4A/30V	2m	0.25mm ²
		4-core straight to angled	CO8.4-2-CB8.4	4	4A/30V	2m	0.25mm ²
	PUR	3-core straight to straight	CO8.3-2-C8.3/P	3	4A/60V	2m	0.25mm ²
		3-core straight to angled	CO8.3-2-CB8.3/P	3	4A/60V	2m	0.25mm ²
		4-core straight to straight	CO8.4-2-C8.4/P	4	4A/30V	2m	0.25mm ²
		4-core straight to angled	CO8.4-2-CB8.4/P	4	4A/30V	2m	0.25mm ²



Double-ended I/O Connector-M8 (female) to M8 (male)

Type Code							
	Cable jacket	Description	Type	Pin	Rated current/voltage	Cable length	Wire section
	PVC	3-core angled to straight	CBO8.3-2-C8.3	3	4A/60V	2m	0.25mm ²
		3-core angled to angled	CBO8.3-2-CB8.3	3	4A/60V	2m	0.25mm ²
		4-core angled to straight	CBO8.4-2-C8.4	4	4A/30V	2m	0.25mm ²
		4-core angled to angled	CBO8.4-2-CB8.4	4	4A/30V	2m	0.25mm ²
	PUR	3-core angled to straight	CBO8.3-2-C8.3/P	3	4A/60V	2m	0.25mm ²
		3-core angled to angled	CBO8.3-2-CB8.3/P	3	4A/60V	2m	0.25mm ²
		4-core angled to straight	CBO8.4-2-C8.4/P	4	4A/30V	2m	0.25mm ²
		4-core angled to angled	CBO8.4-2-CB8.4/P	4	4A/30V	2m	0.25mm ²

Double-ended I/O Cordsets-M8 (female) to M12 (male)

Type Code							
	Cable jacket	Description	Type	Pin	Rated current/voltage	Cable length	Wire section
	PVC	3-core straight to straight	CO8.3-2-C12.3	3	4A/60V	2m	0.25mm ²
		3-core straight to angled	CO8.3-2-CB12.3	3	4A/60V	2m	0.25mm ²
		4-core straight to straight	CO8.4-2-C12.4	4	4A/30V	2m	0.25mm ²
		4-core straight to angled	CO8.4-2-CB12.4	4	4A/30V	2m	0.25mm ²
	PUR	3-core straight to straight	CO8.3-2-C12.3/P	3	4A/60V	2m	0.25mm ²
		3-core straight to angled	CO8.3-2-CB12.3/P	3	4A/60V	2m	0.25mm ²
		4-core straight to straight	CO8.4-2-C12.4/P	4	4A/30V	2m	0.25mm ²
		4-core straight to angled	CO8.4-2-CB12.4/P	4	4A/30V	2m	0.25mm ²

Double-ended I/O Cordsets-M8 (female) to M12 (male)

Type Code							
	Cable jacket	Description	Type	Pin	Rated current/voltage	Cable length	Wire section
	PVC	3-core angled to straight	CBO8.3-2-C12.3	3	4A/60V	2m	0.25mm ²
		3-core angled to angled	CBO8.3-2-CB12.3	3	4A/60V	2m	0.25mm ²
		4-core angled to straight	CBO8.4-2-C12.4	4	4A/30V	2m	0.25mm ²
		4-core angled to angled	CBO8.4-2-CB12.4	4	4A/30V	2m	0.25mm ²
	PUR	3-core angled to straight	CBO8.3-2-C12.3/P	3	4A/60V	2m	0.25mm ²
		3-core angled to angled	CBO8.3-2-CB12.3/P	3	4A/60V	2m	0.25mm ²
		4-core angled to straight	CBO8.4-2-C12.4/P	4	4A/30V	2m	0.25mm ²
		4-core angled to angled	CBO8.4-2-CB12.4/P	4	4A/30V	2m	0.25mm ²

Double-ended I/O Cordsets-M8 (female) to M8 (male)

Type Code							
	Cable jacket	Description	Type	Pin	Rated current/voltage	Cable length	Wire section
	PVC	3-core straight to straight LEDPNP	CO8.3-2-C8.3/L	3	4A/30V	2m	0.25mm ²
		3-core straight to angled LEDPNP	CO8.3-2-CB8.3/L	3	4A/30V	2m	0.25mm ²
		4-core straight to straight LEDPNP	CO8.4-2-C8.4/L	4	4A/30V	2m	0.25mm ²
		4-core straight to angled LEDPNP	CO8.4-2-CB8.4/L	4	4A/30V	2m	0.25mm ²
		3-core straight to straight LEDNPN	CO8.3-2-C8.3/LN	3	4A/30V	2m	0.25mm ²
		3-core straight to angled LEDNPN	CO8.3-2-CB8.3/LN	3	4A/30V	2m	0.25mm ²
		4-core straight to straight LEDNPN	CO8.4-2-C8.4/LN	4	4A/30V	2m	0.25mm ²
		4-core straight to angled LEDNPN	CO8.4-2-CB8.4/LN	4	4A/30V	2m	0.25mm ²
	PUR	3-core straight to straight LEDPNP	CO8.3-2-C8.3/L/P	3	4A/30V	2m	0.25mm ²
		3-core straight to angled LEDPNP	CO8.3-2-CB8.3/L/P	3	4A/30V	2m	0.25mm ²
		4-core straight to straight LEDPNP	CO8.4-2-C8.4/L/P	4	4A/30V	2m	0.25mm ²
		4-core straight to angled LEDPNP	CO8.4-2-CB8.4/L/P	4	4A/30V	2m	0.25mm ²
		3-core straight to straight LEDNPN	CO8.3-2-C8.3/LN/P	3	4A/30V	2m	0.25mm ²
		3-core straight to angled LEDNPN	CO8.3-2-CB8.3/LN/P	3	4A/30V	2m	0.25mm ²
		4-core straight to straight LEDNPN	CO8.4-2-C8.4/LN/P	4	4A/30V	2m	0.25mm ²
		4-core straight to angled LEDNPN	CO8.4-2-CB8.4/LN/P	4	4A/30V	2m	0.25mm ²

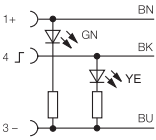
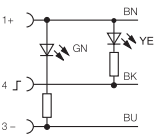
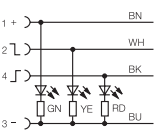
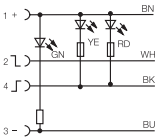
Product with LED	PNP 3-core	NPN 3-core	PNP 4-core	NPN 4-core
				

Double-ended I/O Cordsets-M8 (female) to M8 (male)

Type Code							
	Cable jacket	Description	Type	Pin	Rated current/voltage	Cable length	Wire section
	PVC	3-core angled to straight LEDPNP	CBO8.3-2-C8.3/L	3	4A/30V	2m	0.25mm ²
		3-core angled to angled LEDPNP	CBO8.3-2-CB8.3/L	3	4A/30V	2m	0.25mm ²
		4-core angled to straight LEDPNP	CBO8.4-2-C8.4/L	4	4A/30V	2m	0.25mm ²
		4-core angled to angled LEDPNP	CBO8.4-2-CB8.4/L	4	4A/30V	2m	0.25mm ²
		3-core angled to straight LEDNPN	CBO8.3-2-C8.3/LN	3	4A/30V	2m	0.25mm ²
		3-core angled to angled LEDNPN	CBO8.3-2-CB8.3/LN	3	4A/30V	2m	0.25mm ²
		4-core angled to straight LEDNPN	CBO8.4-2-C8.4/LN	4	4A/30V	2m	0.25mm ²
		4-core angled to angled LEDNPN	CBO8.4-2-CB8.4/LN	4	4A/30V	2m	0.25mm ²
	PUR	3-core straight to straight LEDPNP	CBO8.3-2-C8.3/LP	3	4A/30V	2m	0.25mm ²
		3-core straight to angled LEDPNP	CBO8.3-2-CB8.3/L/P	3	4A/30V	2m	0.25mm ²
		4-core straight to straight LEDPNP	CBO8.4-2-C8.4/L/P	4	4A/30V	2m	0.25mm ²
		4-core straight to angled LEDPNP	CBO8.4-2-CB8.4/L/P	4	4A/30V	2m	0.25mm ²
		3-core straight to straight LEDNPN	CBO8.3-2-C8.3/LN/P	3	4A/30V	2m	0.25mm ²
		3-core straight to angled LEDNPN	CBO8.3-2-CB8.3/LN/P	3	4A/30V	2m	0.25mm ²
		4-core straight to straight LEDNPN	CBO8.4-2-C8.4/LN/P	4	4A/30V	2m	0.25mm ²
		4-core straight to angled LEDNPN	CBO8.4-2-CB8.4/LN/P	4	4A/30V	2m	0.25mm ²

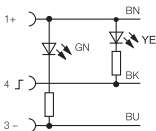
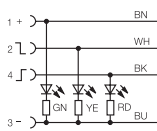
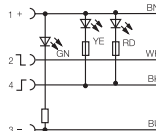
Product with LED	PNP 3-core	NPN 3-core	PNP 4-core	NPN 4-core
				

Double-ended I/O Cordsets-M8 (female) to M12 (male)

Type Code							
	Cable jacket	Description	Type	Pin	Rated current/voltage	Cable length	Wire section
	PVC	3-core straight to straight LEDPNP	CO8.3-2-C12.3/L	3	4A/30V	2m	0.25mm ²
		3-core straight to angled LEDPNP	CO8.3-2-CB12.3/L	3	4A/30V	2m	0.25mm ²
		4-core straight to straight LEDPNP	CO8.4-2-C12.4/L	4	4A/30V	2m	0.25mm ²
		4-core straight to angled LEDPNP	CO8.4-2-CB12.4/L	4	4A/30V	2m	0.25mm ²
		3-core straight to straight LEDNPN	CO8.3-2-C12.3/LN	3	4A/30V	2m	0.25mm ²
		3-core straight to angled LEDNPN	CO8.3-2-CB12.3/LN	3	4A/30V	2m	0.25mm ²
		4-core straight to straight LEDNPN	CO8.4-2-C12.4/LN	4	4A/30V	2m	0.25mm ²
		4-core straight to angled LEDNPN	CO8.4-2-CB12.4/LN	4	4A/30V	2m	0.25mm ²
	PUR	3-core straight to straight LEDPNP	CO8.3-2-C12.3/L/P	3	4A/30V	2m	0.25mm ²
		3-core straight to angled LEDPNP	CO8.3-2-CB12.3/L/P	3	4A/30V	2m	0.25mm ²
		4-core straight to straight LEDPNP	CO8.4-2-C12.4/L/P	4	4A/30V	2m	0.25mm ²
		4-core straight to angled LEDPNP	CO8.4-2-CB12.4/L/P	4	4A/30V	2m	0.25mm ²
		3-core straight to straight LEDNPN	CO8.3-2-C12.3/LN/P	3	4A/30V	2m	0.25mm ²
		3-core straight to angled LEDNPN	CO8.3-2-CB12.3/LN/P	3	4A/30V	2m	0.25mm ²
		4-core straight to straight LEDNPN	CO8.4-2-C12.4/LN/P	4	4A/30V	2m	0.25mm ²
		4-core straight to angled LEDNPN	CO8.4-2-CB12.4/LN/P	4	4A/30V	2m	0.25mm ²

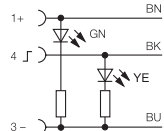
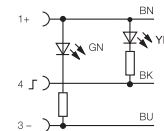
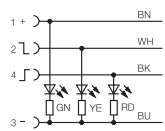
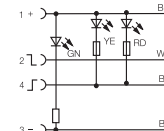
Product with LED	PNP 3-core	NPN 3-core	PNP 4-core	NPN 4-core
				

Double-ended I/O Cordsets-M8 (female) to M12 (male)

Type Code							
	Cable jacket	Description	Type	Pin	Rated current/voltage	Cable length	Wire section
	PVC	3-core angled to straight LEDPNP	CBO8.3-2-C12.3/L	3	4A/30V	2m	0.25mm ²
		3-core angled to angled LEDPNP	CBO8.3-2-CB12.3/L	3	4A/30V	2m	0.25mm ²
		4-core angled to straight LEDPNP	CBO8.4-2-C12.4/L	4	4A/30V	2m	0.25mm ²
		4-core angled to angled LEDPNP	CBO8.4-2-CB12.4/L	4	4A/30V	2m	0.25mm ²
		3-core angled to straight LEDNPN	CBO8.3-2-C12.3/LN	3	4A/30V	2m	0.25mm ²
		3-core angled to angled LEDNPN	CBO8.3-2-CB12.3/LN	3	4A/30V	2m	0.25mm ²
		4-core angled to straight LEDNPN	CBO8.4-2-C12.4/LN	4	4A/30V	2m	0.25mm ²
		4-core angled to angled LEDNPN	CBO8.4-2-CB12.4/LN	4	4A/30V	2m	0.25mm ²
	PUR	3-core angled to straight LEDPNP	CBO8.3-2-C12.3/L/P	3	4A/30V	2m	0.25mm ²
		3-core angled to angled LEDPNP	CBO8.3-2-CB12.3/L/P	3	4A/30V	2m	0.25mm ²
		4-core angled to straight LEDPNP	CBO8.4-2-C12.4/L/P	4	4A/30V	2m	0.25mm ²
		4-core angled to angled LEDPNP	CBO8.4-2-CB12.4/L/P	4	4A/30V	2m	0.25mm ²
		3-core angled to straight LEDNPN	CBO8.3-2-C12.3/LN/P	3	4A/30V	2m	0.25mm ²
		3-core angled to angled LEDNPN	CBO8.3-2-CB12.3/LN/P	3	4A/30V	2m	0.25mm ²
		4-core angled to straight LEDNPN	CBO8.4-2-C12.4/LN/P	4	4A/30V	2m	0.25mm ²
		4-core angled to angled LEDNPN	CBO8.4-2-CB12.4/LN/P	4	4A/30V	2m	0.25mm ²

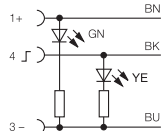
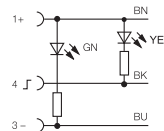
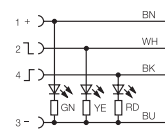
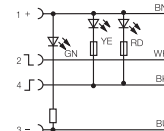
Product with LED	PNP 3-core	NPN 3-core	PNP 4-core	NPN 4-core
				

Y Splitter M8-male to M8-female

Type Code							
	Cable jacket	Description	Type	Pin	Rated current/voltage	Cable length	Wire section
	PVC	Straight to 2 straight	ECS-E2CO8.3-2/2	4-3/3	4A/30V	2m	0.25mm ²
		Straight to 2 angled	ECS-E2CBO8.3-2/2	4-3/3	4A/30V	2m	0.25mm ²
	PUR	Straight to 2 straight	ECS-E2CO8.3-2/2/P	4-3/3	4A/30V	2m	0.25mm ²
		Straight to 2 angled	ECS-E2CBO8.3-2/2/P	4-3/3	4A/30V	2m	0.25mm ²

Wiring Diagram

Standard

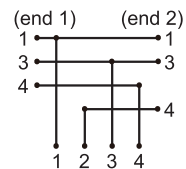

Y Splitter M8-male to M12-female



Type Code							
	Cable jacket	Description	Type	Pin	Rated current/voltage	Cable length	Wire section
	PVC	Straight to 2 straight	ECS-E2CO12.3-2/2	4-3/3	4A/30V	2m	0.25mm ²
		Straight to 2 angled	ECS-E2CBO12.3-2/2	4-3/3	4A/30V	2m	0.25mm ²
	PUR	Straight to 2 straight	ECS-E2CO12.3-2/2/P	4-3/3	4A/30V	2m	0.25mm ²
		Straight to 2 angled	ECS-E2CBO12.3-2/2/P	4-3/3	4A/30V	2m	0.25mm ²

Wiring Diagram

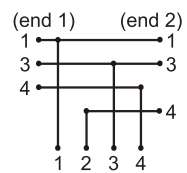
Standard



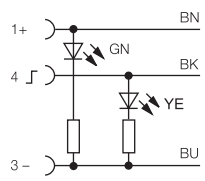
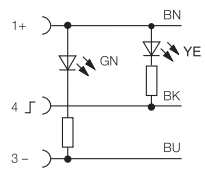

Y Splitter M8-male to M8-female

Type Code								
	Cable jacket	Description	Type	Pin	Rated current/voltage	Cable length	Wire section	
	PVC	Straight to 2 straight	PNP	ECS-E2CO8.3-2/2/L	4-3/3	4A/30V	2m	0.25mm ²
		Straight to 2 angled	PNP	ECS-E2CBO8.3-2/2/L	4-3/3	4A/30V	2m	0.25mm ²
		Straight to 2 straight	NPN	ECS-E2CO8.3-2/2/LN	4-3/3	4A/30V	2m	0.25mm ²
		Straight to 2 angled	NPN	ECS-E2CBO8.3-2/2/LN	4-3/3	4A/30V	2m	0.25mm ²
	PUR	Straight to 2 straight	PNP	ECS-E2CO8.3-2/2/L/P	4-3/3	4A/30V	2m	0.25mm ²
		Straight to 2 angled	PNP	ECS-E2CBO8.3-2/2/L/P	4-3/3	4A/30V	2m	0.25mm ²
		Straight to 2 straight	NPN	ECS-E2CO8.3-2/2/LN/P	4-3/3	4A/30V	2m	0.25mm ²
		Straight to 2 angled	NPN	ECS-E2CBO8.3-2/2/LN/P	4-3/3	4A/30V	2m	0.25mm ²

Product with LED	PNP 3-core	NPN 3-core
	 <p>The diagram shows a 3-core PNP LED circuit. Pin 1+ is connected to the anode of a green LED (GN) and the anode of a yellow LED (YE). Pin 4 is connected to the cathode of the green LED and the cathode of the yellow LED. Pin 3- is connected to the common ground of both LEDs. The BK wire is also connected to the common ground.</p>	 <p>The diagram shows a 3-core NPN LED circuit. Pin 1+ is connected to the anode of a green LED (GN) and the anode of a yellow LED (YE). Pin 4 is connected to the cathode of the green LED and the cathode of the yellow LED. Pin 3- is connected to the common ground of both LEDs. The BK wire is also connected to the common ground.</p>

Y Splitter M8-male to M12-female

Type Code							
	Cable jacket	Description	Type	Pin	Rated current/voltage	Cable length	Wire section
	PVC	Straight to 2 straight	PNP	ECS-E2CO12.3-2/2/L	4-3/3	4A/30V	2m 0.25mm ²
		Straight to 2 angled	PNP	ECS-E2CBO12.3-2/2/L	4-3/3	4A/30V	2m 0.25mm ²
		Straight to 2 straight	NPN	ECS-E2CO12.3-2/2/LN	4-3/3	4A/30V	2m 0.25mm ²
		Straight to 2 angled	NPN	ECS-E2CBO12.3-2/2/LN	4-3/3	4A/30V	2m 0.25mm ²
	PUR	Straight to 2 straight	PNP	ECS-E2CO12.3-2/2/L/P	4-3/3	4A/30V	2m 0.25mm ²
		Straight to 2 angled	PNP	ECS-E2CBO12.3-2/2/L/P	4-3/3	4A/30V	2m 0.25mm ²
		Straight to 2 straight	NPN	ECS-E2CO12.3-2/2/LN/P	4-3/3	4A/30V	2m 0.25mm ²
		Straight to 2 angled	NPN	ECS-E2CBO12.3-2/2/LN/P	4-3/3	4A/30V	2m 0.25mm ²

Product with LED

PNP 3-core

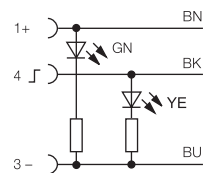

NPN 3-core

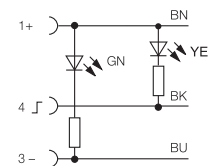

A photograph of an automotive assembly line. Several silver cars are on the line, with their hoods and doors open. Robotic arms and overhead equipment are visible. The scene is dimly lit, with a dark overlay. The text 'I/O' is in the top left, 'Connectors' is in the middle, and 'M8 Snap' is at the bottom.

I/O

Connectors

M8 Snap

Single-ended I/O Cordsets- Φ8 (Straight- female)

Description:

Used for sensors, I/O connector connecting. Standard Φ8(straight-female) threaded connection. 3, 4, 5-core are optional. Customized cable lengths. Degree of protection IP67.

Features:

- PVC, PUR cable are optional
- A-coded (3-,4-core) interface
- A-coded (5-core) interface
- LED indicator is optional

* All technical information about the raw cable for connectors, please refer to the "cable" section (P513).

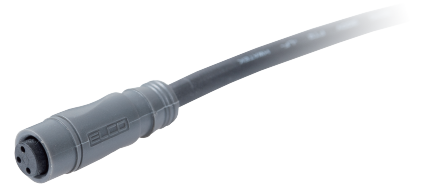

Type Code

Cable jacket	Description	Type	Pin	Rated current/voltage	Cable length	Wire section
PVC	Female 3-core	QO8.3-2	3	4A/60V	2m	0.25mm ²
	Female 4-core	QO8.4-2	4	4A/30V	2m	0.25mm ²
PUR	Female 3-core	QO8.3-2/P	3	4A/60V	2m	0.25mm ²
	Female 4-core	QO8.4-2/P	4	4A/30V	2m	0.25mm ²
	Female 5-core	QO8.5-2/P	5	2A/30V	2m	0.25mm ²

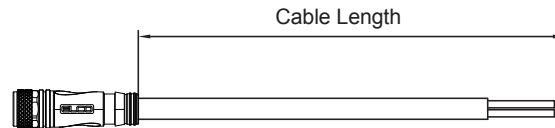

Selection Instructions

QO8.3 - 2 / P

① ②

Attn : ①: Customized cable lengths are available.

②: Cable jacket or function can be customized according to the requirements.

Single-ended I/O Cordsets- Φ8 (Angled- female)

Description:

Used for sensors, I/O connector connecting. Standard Φ8(angled-female) threaded connection. 3, 4, 5-core are optional. Customized cable lengths. Degree of protection IP67.

Features:

- PVC, PUR are optional
- A-coded (3-,4-core) interface
- A-coded (5-core) interface
- LED indicator is optional

* All technical information about the raw cable for connectors, please refer to the "cable" section (P513).



Type Code

Cable jacket	Description	Type	Pin	Rated current/voltage	Cable length	Wire section
PVC	Female 3-core	QBO8.3-2	3	4A/60V	2m	0.25mm ²
	Female 3-core	QBO8.4-2	4	4A/30V	2m	0.25mm ²
PUR	Female 3-core	QBO8.3-2/P	3	4A/60V	2m	0.25mm ²
	Female 4-core	QBO8.4-2/P	4	4A/30V	2m	0.25mm ²
	Female 5-core	QBO8.5-2/P	5	2A/30V	2m	0.25mm ²

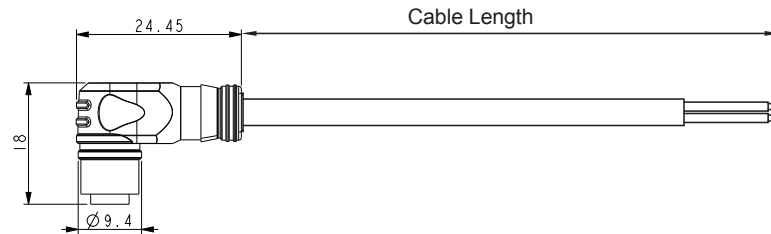

Selection Instructions

QBO8.3 - 2 / P

① ②

Attn : ①: Customized cable lengths are available.

②: Cable jacket or function can be customized according to the requirements.

A large yellow industrial robot arm is the central focus, positioned in a factory setting. The background shows a complex network of metal beams, pipes, and other machinery, typical of an automotive assembly plant. The lighting is somewhat dim, with the robot's yellow color standing out. The overall scene conveys a sense of advanced manufacturing technology.

I/O

Connectors

M12

Single-ended I/O Cordsets- M12 (Straight-female)

Type Code						
Cable jacket	Description	Type	Pin	Rated current/voltage	Cable length	Wire section
 PVC	Female DC 2-core	CO12.2-2	2	4A/250V	2m	0.34mm ²
	Female AC/DC 2-core	CO12.21-2	2	4A/250V	2m	0.34mm ²
	Female AC 2-core	CO12.22-2	2	4A/250V	2m	0.34mm ²
	Female 3-core NO	CO12.3-2	3	4A/250V	2m	0.34mm ²
	Female 3-core NO with LEDPNP	CO12.3-2/L	3	4A/30V	2m	0.34mm ²
	Female 3-core NO with LEDNPN	CO12.3-2/LN	3	4A/30V	2m	0.34mm ²
	Female 4-core NO/NC	CO12.4-2	4	4A/250V	2m	0.34mm ²
	Female 4-core NO/NC with LEDPNP	CO12.4-2/L	4	4A/30V	2m	0.34mm ²
	Female 4-core NO/NC with LEDNPN	CO12.4-2/LN	4	4A/30V	2m	0.34mm ²
	Female 5-core NO/NC	CO12.5-2	5	4A/60V	2m	0.34mm ²
	Female 8-core	CO12.8-2	8	2A/30V	2m	0.25mm ²
PUR	Female DC 2-core	CO12.2-2/P	2	4A/250V	2m	0.34mm ²
	Female AC/DC 2-core	CO12.21-2/P	2	4A/250V	2m	0.34mm ²
	Female AC 2-core	CO12.22-2/P	2	4A/250V	2m	0.34mm ²
	Female 3-core NO	CO12.3-2/P	3	4A/250V	2m	0.34mm ²
	Female 3-core NO with LEDPNP	CO12.3-2/L/P	3	4A/30V	2m	0.34mm ²
	Female 3-core NO with LEDNPN	CO12.3-2/LN/P	3	4A/30V	2m	0.34mm ²
	Female 4-core NO/NC	CO12.4-2/P	4	4A/250V	2m	0.34mm ²
	Female 4-core NO/NC with LEDPNP	CO12.4-2/L/P	4	4A/30V	2m	0.34mm ²
	Female 4-core NO/NC with LEDNPN	CO12.4-2/LN/P	4	4A/30V	2m	0.34mm ²
	Female 5-core NO/NC	CO12.5-2/P	5	4A/60V	2m	0.34mm ²
	Female 8-core	CO12.8-2/P	8	2A/30V	2m	0.25mm ²

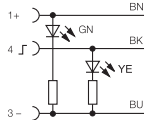
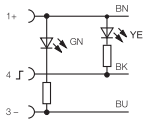
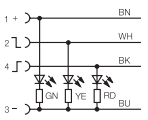
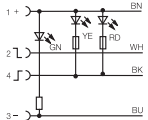
Product with LED	PNP 3-core	NPN 3-core	PNP 4-core	NPN 4-core
				

Single-ended I/O Cordsets- M12 (Straight-male)

Type Code						
Cable jacket	Description	Type	Pin	Rated current/voltage	Cable length	Wire section
PVC	Male DC 2-core	C12.2-2	2	4A/250V	2m	0.34mm ²
	Male AC/DC 2-core	C12.21-2	2	4A/250V	2m	0.34mm ²
	Male AC 2-core	C12.22-2	2	4A/250V	2m	0.34mm ²
	Male 3-core NO	C12.3-2	3	4A/250V	2m	0.34mm ²
	Male 4-core NO/NC	C12.4-2	4	4A/250V	2m	0.34mm ²
	Male 5-core NO/NC	C12.5-2	5	4A/60V	2m	0.34mm ²
	Male 8-core	C12.8-2	8	2A/30V	2m	0.25mm ²
PUR	Male DC 2-core	C12.2-2/P	2	4A/250V	2m	0.34mm ²
	Male AC/DC 2-core	C12.21-2/P	2	4A/250V	2m	0.34mm ²
	Male AC 2-core	C12.22-2/P	2	4A/250V	2m	0.34mm ²
	Male 3-core NO	C12.3-2/P	3	4A/250V	2m	0.34mm ²
	Male 4-core NO/NC	C12.4-2/P	4	4A/250V	2m	0.34mm ²
	Male 5-core NO/NC	C12.5-2/P	5	4A/60V	2m	0.34mm ²
	Male 8-core	C12.8-2/P	8	2A/30V	2m	0.25mm ²



Single-ended I/O Cordsets-M12 (Angled-female)

Type Code							
	Cable jacket	Description	Type	Pin	Rated current/voltage	Cable length	Wire section
	PVC	Female DC 2-core	CBO12.2-2	2	4A/250V	2m	0.34mm ²
		Female AC/DC 2-core	CBO12.21-2	2	4A/250V	2m	0.34mm ²
		Female AC 2-core	CBO12.22-2	2	4A/250V	2m	0.34mm ²
		Female 3-core NO	CBO12.3-2	3	4A/250V	2m	0.34mm ²
		Female 3-core NO with LEDPNP	CBO12.3-2/L	3	4A/30V	2m	0.34mm ²
		Female 3-core NO with LEDNPN	CBO12.3-2/LN	3	4A/30V	2m	0.34mm ²
		Female 4-core NO/NC	CBO12.4-2	4	4A/250V	2m	0.34mm ²
		Female 4-core NO/NC with LEDPNP	CBO12.4-2/L	4	4A/30V	2m	0.34mm ²
		Female 4-core NO/NC with LEDNPN	CBO12.4-2/LN	4	4A/30V	2m	0.34mm ²
		Female 5-core NO/NC	CBO12.5-2	5	4A/60V	2m	0.34mm ²
		Female 8-core	CBO12.8-2	8	2A/30V	2m	0.25mm ²
	PUR	Female DC 2-core	CBO12.2-2/P	2	4A/250V	2m	0.34mm ²
		Female AC/DC 2-core	CBO12.21-2/P	2	4A/250V	2m	0.34mm ²
		Female AC 2-core	CBO12.22-2/P	2	4A/250V	2m	0.34mm ²
		Female 3-core NO	CBO12.3-2/P	3	4A/250V	2m	0.34mm ²
		Female 3-core NO with LEDPNP	CBO12.3-2/L/P	3	4A/30V	2m	0.34mm ²
		Female 3-core NO with LEDNPN	CBO12.3-2/LN/P	3	4A/30V	2m	0.34mm ²
		Female 4-core NO/NC	CBO12.4-2/P	4	4A/250V	2m	0.34mm ²
		Female 4-core NO/NC with LEDPNP	CBO12.4-2/L/P	4	4A/30V	2m	0.34mm ²
		Female 4-core NO/NC with LEDNPN	CBO12.4-2/LN/P	4	4A/30V	2m	0.34mm ²
		Female 5-core NO/NC	CBO12.5-2/P	5	4A/60V	2m	0.34mm ²
		Female 8-core	CBO12.8-2/P	8	2A/30V	2m	0.25mm ²

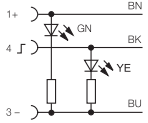
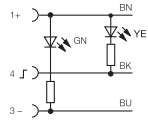
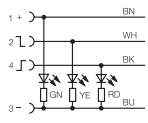
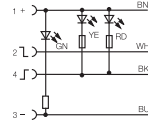
Product with LED	PNP 3-core	NPN 3-core	PNP 4-core	NPN 4-core
				

Single-ended I/O Cordsets-M12 (Angled-male)

Type Code						
Cable jacket	Description	Type	Pin	Rated current/voltage	Cable length	Wire section
 PVC	Male DC 2-core	CB12.2-2	2	4A/250V	2m	0.34mm ²
	Male AC/DC 2-core	CB12.21-2	2	4A/250V	2m	0.34mm ²
	Male AC 2-core	CB12.22-2	2	4A/250V	2m	0.34mm ²
	Male 3-core NO	CB12.3-2	3	4A/250V	2m	0.34mm ²
	Male 4-core NO/NC	CB12.4-2	4	4A/250V	2m	0.34mm ²
	Male 5-core NO/NC	CB12.5-2	5	4A/60V	2m	0.34mm ²
	Male 8-core	CB12.8-2	8	2A/30V	2m	0.25mm ²
PUR	Male DC 2-core	CB12.2-2/P	2	4A/250V	2m	0.34mm ²
	Male AC/DC 2-core	CB12.21-2/P	2	4A/250V	2m	0.34mm ²
	Male AC 2-core	CB12.22-2/P	2	4A/250V	2m	0.34mm ²
	Male 3-core NO	CB12.3-2/P	3	4A/250V	2m	0.34mm ²
	Male 4-core NO/NC	CB12.4-2/P	4	4A/250V	2m	0.34mm ²
	Male 5-core NO/NC	CB12.5-2/P	5	4A/60V	2m	0.34mm ²
	Male 8-core	CB12.8-2/P	8	2A/30V	2m	0.25mm ²

Single-ended I/O Cordsets-M12 (Straight-female)

Type Code							
Cable jacket	Description	Type	Pin	Rated current/voltage	Cable length	Wire section	
	Welding spark resistance	Female 3-core	CO12.3-2/EWSR	3	4A/250V	2m	0.34mm ²
		Female 4-core	CO12.4-2/EWSR	4	4A/250V	2m	0.34mm ²
		Female 5-core	CO12.5-2/EWSR	5	4A/60V	2m	0.34mm ²
PVC Shielded	Female 3-core	CO12.3-2/WS	3	4A/250V	2m	0.34mm ²	
	Female 4-core	CO12.4-2/WS	4	4A/250V	2m	0.34mm ²	
	Female 5-core	CO12.5-2/WS	5	4A/60V	2m	0.34mm ²	
	Female 8-core	CO12.8-2/WS	8	2A/30V	2m	0.25mm ²	
PUR Shielded	Female 3-core	CO12.3-2/WS/P	3	4A/250V	2m	0.34mm ²	
	Female 4-core	CO12.4-2/WS/P	4	4A/250V	2m	0.34mm ²	
	Female 5-core	CO12.5-2/WS/P	5	4A/60V	2m	0.34mm ²	
	Female 8-core	CO12.8-2/WS/P	8	2A/30V	2m	0.25mm ²	
	Female 12-core	CO12.12-2/WS/P	12	1.5A/30V	2m	0.25mm ²	

Single-ended I/O Cordsets-M12 (Straight-male)

Type Code							
	Cable jacket	Description	Type	Pin	Rated current/voltage	Cable length	Wire section
	Welding spark resistance	Male 3-core	C12.3-2/EWSR	3	4A/250V	2m	0.34mm ²
		Male 4-core	C12.4-2/EWSR	4	4A/250V	2m	0.34mm ²
		Male 5-core	C12.5-2/EWSR	5	4A/60V	2m	0.34mm ²
	PVC Shielded	Male 3-core	C12.3-2/WS	3	4A/250V	2m	0.34mm ²
		Male 4-core	C12.4-2/WS	4	4A/250V	2m	0.34mm ²
		Male 5-core	C12.5-2/WS	5	4A/60V	2m	0.34mm ²
		Male 8-core	C12.8-2/WS	8	2A/30V	2m	0.25mm ²
	PUR Shielded	Male 3-core	C12.3-2/WS/P	3	4A/250V	2m	0.34mm ²
		Male 4-core	C12.4-2/WS/P	4	4A/250V	2m	0.34mm ²
Male 5-core		C12.5-2/WS/P	5	4A/60V	2m	0.34mm ²	
Male 8-core		C12.8-2/WS/P	8	2A/30V	2m	0.25mm ²	

Single-ended I/O Cordsets-M12 (Angled-female)



Type Code						
Cable jacket	Description	Type	Pin	Rated current/voltage	Cable length	Wire section
 Welding spark resistance	Female 3-core	CBO12.3-2/EWSR	3	4A/250V	2m	0.34mm ²
	Female 4-core	CBO12.4-2/EWSR	4	4A/250V	2m	0.34mm ²
	Female 5-core	CBO12.5-2/EWSR	5	4A/60V	2m	0.34mm ²
PVC Shielded	Female 3-core	CBO12.3-2/WS	3	4A/250V	2m	0.34mm ²
	Female 4-core	CBO12.4-2/WS	4	4A/250V	2m	0.34mm ²
	Female 5-core	CBO12.5-2/WS	5	4A/60V	2m	0.34mm ²
	Female 8-core	CBO12.8-2/WS	8	2A/30V	2m	0.25mm ²
PUR Shielded	Female 3-core	CBO12.3-2/WS/P	3	4A/250V	2m	0.34mm ²
	Female 4-core	CBO12.4-2/WS/P	4	4A/250V	2m	0.34mm ²
	Female 5-core	CBO12.5-2/WS/P	5	4A/60V	2m	0.34mm ²
	Female 8-core	CBO12.8-2/WS/P	8	2A/30V	2m	0.25mm ²

Single-ended I/O Cordsets-M12 (Angled-male)



Type Code						
Cable jacket	Description	Type	Pin	Rated current/voltage	Cable length	Wire section
Welding spark resistance	Male 3-core	CB12.3-2/EWSR	3	4A/250V	2m	0.34mm ²
	Male 4-core	CB12.4-2/EWSR	4	4A/250V	2m	0.34mm ²
	Male 5-core	CB12.5-2/EWSR	5	4A/60V	2m	0.34mm ²
PVC Shielded	Male 3-core	CB12.3-2/WS	3	4A/250V	2m	0.34mm ²
	Male 4-core	CB12.4-2/WS	4	4A/250V	2m	0.34mm ²
	Male 5-core	CB12.5-2/WS	5	4A/60V	2m	0.34mm ²
	Male 8-core	CB12.8-2/WS	8	2A/30V	2m	0.25mm ²
PUR Shielded	Male 3-core	CB12.3-2/WS/P	3	4A/250V	2m	0.34mm ²
	Male 4-core	CB12.4-2/WS/P	4	4A/250V	2m	0.34mm ²
	Male 5-core	CB12.5-2/WS/P	5	4A/60V	2m	0.34mm ²
	Male 8-core	CB12.8-2/WS/P	8	2A/30V	2m	0.25mm ²





Double-ended I/O Cordsets-M12 (female) to M12 (male)

Type Code							
	Cable jacket	Description	Type	Pin	Rated current/voltage	Cable length	Wire section
	PVC	3-core straight to straight	CO12.3-2-C12.3	3	4A/250V	2m	0.34mm ²
		3-core straight to angled	CO12.3-2-CB12.3	3	4A/250V	2m	0.34mm ²
		4-core straight to straight	CO12.4-2-C12.4	4	4A/250V	2m	0.34mm ²
		4-core straight to angled	CO12.4-2-CB12.4	4	4A/250V	2m	0.34mm ²
		5-core straight to straight	CO12.5-2-C12.5	5	4A/60V	2m	0.34mm ²
		5-core straight to angled	CO12.5-2-CB12.5	5	4A/60V	2m	0.34mm ²
	PUR	3-core straight to straight	CO12.3-2-C12.3/P	3	4A/250V	2m	0.34mm ²
		3-core straight to angled	CO12.3-2-CB12.3/P	3	4A/250V	2m	0.34mm ²
		4-core straight to straight	CO12.4-2-C12.4/P	4	4A/250V	2m	0.34mm ²
		4-core straight to angled	CO12.4-2-CB12.4/P	4	4A/250V	2m	0.34mm ²
		5-core straight to straight	CO12.5-2-C12.5/P	5	4A/60V	2m	0.34mm ²
		5-core straight to angled	CO12.5-2-CB12.5/P	5	4A/60V	2m	0.34mm ²



Double-ended I/O Cordsets-M12 (female) to M12 (male)

Type Code							
	Cable jacket	Description	Type	Pin	Rated current/voltage	Cable length	Wire section
	PVC	3-core angled to straight	CBO12.3-2-C12.3	3	4A/250V	2m	0.34mm ²
		3-core angled to angled	CBO12.3-2-CB12.3	3	4A/250V	2m	0.34mm ²
		4-core angled to straight	CBO12.4-2-C12.4	4	4A/250V	2m	0.34mm ²
		4-core angled to angled	CBO12.4-2-CB12.4	4	4A/250V	2m	0.34mm ²
		5-core angled to straight	CBO12.5-2-C12.5	5	4A/60V	2m	0.34mm ²
		5-core angled to angled	CBO12.5-2-CB12.5	5	4A/60V	2m	0.34mm ²
	PUR	3-core angled to straight	CBO12.3-2-C12.3/P	3	4A/250V	2m	0.34mm ²
		3-core angled to angled	CBO12.3-2-CB12.3/P	3	4A/250V	2m	0.34mm ²
		4-core angled to straight	CBO12.4-2-C12.4/P	4	4A/250V	2m	0.34mm ²
		4-core angled to angled	CBO12.4-2-CB12.4/P	4	4A/250V	2m	0.34mm ²
		5-core angled to straight	CBO12.5-2-C12.5/P	5	4A/60V	2m	0.34mm ²
		5-core angled to angled	CBO12.5-2-CB12.5/P	5	4A/60V	2m	0.34mm ²

Double-ended I/O Cordsets-M12 (female) to M8 (male)

Type Code							
	Cable jacket	Description	Type	Pin	Rated current/voltage	Cable length	Wire section
	PVC	3-core straight to straight	CO12.3-2-C8.3	3	4A/60V	2m	0.25mm ²
		3-core straight to angled	CO12.3-2-CB8.3	3	4A/60V	2m	0.25mm ²
		4-core straight to straight	CO12.4-2-C8.4	4	4A/30V	2m	0.25mm ²
		4-core straight to angled	CBO12.4-2-CB8.4	4	4A/30V	2m	0.25mm ²
	PUR	3-core straight to straight	CO12.3-2-C8.3/P	3	4A/60V	2m	0.25mm ²
		3-core straight to angled	CO12.3-2-CB8.3/P	3	4A/60V	2m	0.25mm ²
		4-core straight to straight	CO12.4-2-C8.4/P	4	4A/30V	2m	0.25mm ²
		4-core straight to angled	CO12.4-2-CB8.4/P	4	4A/30V	2m	0.25mm ²

Double-ended I/O Cordsets-M12 (female) to M8 (male)

Type Code							
	Cable jacket	Description	Type	Pin	Rated current/voltage	Cable length	Wire section
	PVC	3-core angled to straight	CBO12.3-2-CB8.3	3	4A/60V	2m	0.25mm ²
		3-core angled to angled	CBO12.3-2-CB8.3	3	4A/60V	2m	0.25mm ²
		4-core angled to straight	CBO12.4-2-CB8.4	4	4A/30V	2m	0.25mm ²
		4-core angled to angled	CBO12.4-2-CB8.4	4	4A/30V	2m	0.25mm ²
	PUR	3-core angled to straight	CBO12.3-2-CB8.3/P	3	4A/60V	2m	0.25mm ²
		3-core angled to angled	CBO12.3-2-CB8.3/P	3	4A/60V	2m	0.25mm ²
		4-core angled to straight	CBO12.4-2-CB8.4/P	4	4A/30V	2m	0.25mm ²
		4-core angled to angled	CBO12.4-2-CB8.4/P	4	4A/30V	2m	0.25mm ²

Double-ended I/O Cordsets-M12 (female) to M12 (male)

Type Code							
	Cable jacket	Description	Type	Pin	Rated current/voltage	Cable length	Wire section
	PVC	3-core straight to straight LEDPNP	CO12.3-2-C12.3/L	3	4A/30V	2m	0.34mm ²
		3-core straight to angled LEDPNP	CO12.3-2-CB12.3/L	3	4A/30V	2m	0.34mm ²
		4-core straight to straight LEDPNP	CO12.4-2-C12.4/L	4	4A/30V	2m	0.34mm ²
		4-core straight to angled LEDPNP	CO12.4-2-CB12.4/L	4	4A/30V	2m	0.34mm ²
		3-core straight to straight LEDNPN	CO12.3-2-C12.3/LN	3	4A/30V	2m	0.34mm ²
		3-core straight to angled LEDNPN	CO12.3-2-CB12.3/LN	3	4A/30V	2m	0.34mm ²
		4-core straight to straight LEDNPN	CO12.4-2-C12.4/LN	4	4A/30V	2m	0.34mm ²
		4-core straight to angled LEDNPN	CO12.4-2-CB12.4/LN	4	4A/30V	2m	0.34mm ²
	PUR	3-core straight to straight LEDPNP	CO12.3-2-C12.3/L/P	3	4A/30V	2m	0.34mm ²
		3-core straight to angled LEDPNP	CO12.3-2-CB12.3/L/P	3	4A/30V	2m	0.34mm ²
		4-core straight to straight LEDPNP	CO12.4-2-C12.4/L/P	4	4A/30V	2m	0.34mm ²
		4-core straight to angled LEDPNP	CO12.4-2-CB12.4/L/P	4	4A/30V	2m	0.34mm ²
		3-core straight to straight LEDNPN	CO12.3-2-C12.3/LN/P	3	4A/30V	2m	0.34mm ²
		3-core straight to angled LEDNPN	CO12.3-2-CB12.3/LN/P	3	4A/30V	2m	0.34mm ²
		4-core straight to straight LEDNPN	CO12.4-2-C12.4/LN/P	4	4A/30V	2m	0.34mm ²
		4-core straight to angled LEDNPN	CO12.4-2-CB12.4/LN/P	4	4A/30V	2m	0.34mm ²

Product with LED	PNP 3-core	NPN 3-core	PNP 4-core	NPN 4-core

Double-ended I/O Cordsets-M12 (female) to M12 (male)

Type Code							
	Cable jacket	Description	Type	Pin	Rated current/voltage	Cable length	Wire section
	PVC	3-core angled to straight LEDPNP	CBO12.3-2-C12.3/L	3	4A/30V	2m	0.25mm ²
		3-core angled to angled LEDPNP	CBO12.3-2-CB12.3/L	3	4A/30V	2m	0.25mm ²
		4-core angled to straight LEDPNP	CBO12.4-2-C12.4/L	4	4A/30V	2m	0.25mm ²
		4-core angled to angled LEDPNP	CBO12.4-2-CB12.4/L	4	4A/30V	2m	0.25mm ²
		3-core angled to straight LEDNPN	CBO12.3-2-C12.3/LN	3	4A/30V	2m	0.25mm ²
		3-core angled to angled LEDNPN	CBO12.3-2-CB12.3/LN	3	4A/30V	2m	0.25mm ²
		4-core angled to straight LEDNPN	CBO12.4-2-C12.4/LN	4	4A/30V	2m	0.25mm ²
		4-core angled to angled LEDNPN	CBO12.4-2-CB12.4/LN	4	4A/30V	2m	0.25mm ²
	PUR	3-core angled to straight LEDPNP	CBO12.3-2-C12.3/L/P	3	4A/30V	2m	0.25mm ²
		3-core angled to angled LEDPNP	CBO12.3-2-CB12.3/L/P	3	4A/30V	2m	0.25mm ²
		4-core angled to straight LEDPNP	CBO12.4-2-C12.4/L/P	4	4A/30V	2m	0.25mm ²
		4-core angled to angled LEDPNP	CBO12.4-2-CB12.4/L/P	4	4A/30V	2m	0.25mm ²
		3-core angled to straight LEDNPN	CBO12.3-2-C12.3/LN/P	3	4A/30V	2m	0.25mm ²
		3-core angled to angled LEDNPN	CBO12.3-2-CB12.3/LN/P	3	4A/30V	2m	0.25mm ²
		4-core angled to straight LEDNPN	CBO12.4-2-C12.4/LN/P	4	4A/30V	2m	0.25mm ²
		4-core angled to angled LEDNPN	CBO12.4-2-CB12.4/LN/P	4	4A/30V	2m	0.25mm ²

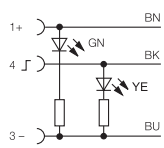
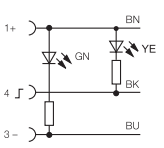
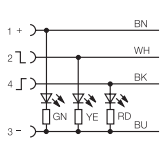
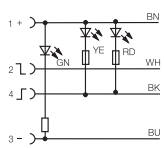
Product with LED	PNP 3-core	NPN 3-core	PNP 4-core	NPN 4-core
				

Double-ended I/O Cordsets-M12 (female) to M8 (male)

Type Code							
	Cable jacket	Description	Type	Pin	Rated current/voltage	Cable length	Wire section
	PVC	3-core straight to straight LEDPNP	CO12.3-2-C8.3/L	3	4A/30V	2m	0.25mm ²
		3-core straight to angled LEDPNP	CO12.3-2-CB8.3/L	3	4A/30V	2m	0.25mm ²
		4-core straight to straight LEDPNP	CO12.4-2-C8.4/L	4	4A/30V	2m	0.25mm ²
		4-core straight to angled LEDPNP	CO12.4-2-CB8.4/L	4	4A/30V	2m	0.25mm ²
		3-core straight to straight LEDNPN	CO12.3-2-C8.3/LN	3	4A/30V	2m	0.25mm ²
		3-core straight to angled LEDNPN	CO12.3-2-CB8.3/LN	3	4A/30V	2m	0.25mm ²
		4-core straight to straight LEDNPN	CO12.4-2-C8.4/LN	4	4A/30V	2m	0.25mm ²
		4-core straight to angled LEDNPN	CO12.4-2-CB8.4/LN	4	4A/30V	2m	0.25mm ²
	PUR	3-core straight to straight LEDPNP	CO12.3-2-C8.3/L/P	3	4A/30V	2m	0.25mm ²
		3-core straight to angled LEDPNP	CO12.3-2-CB8.3/L/P	3	4A/30V	2m	0.25mm ²
		4-core straight to straight LEDPNP	CO12.4-2-C8.4/L/P	4	4A/30V	2m	0.25mm ²
		4-core straight to angled LEDPNP	CO12.4-2-CB8.4/L/P	4	4A/30V	2m	0.25mm ²
		3-core straight to straight LEDNPN	CO12.3-2-C8.3/LN/P	3	4A/30V	2m	0.25mm ²
		3-core straight to angled LEDNPN	CO12.3-2-CB8.3/LN/P	3	4A/30V	2m	0.25mm ²
		4-core straight to straight LEDNPN	CO12.4-2-C8.4/LN/P	4	4A/30V	2m	0.25mm ²
		4-core straight to angled LEDNPN	CO12.4-2-CB8.4/LN/P	4	4A/30V	2m	0.25mm ²

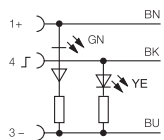
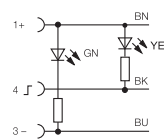
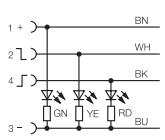
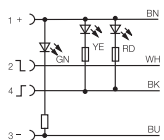

Product with LED	PNP 3-core	NPN 3-core	PNP 4-core	NPN 4-core
				

Double-ended I/O Cordsets-M12 (female) to M8 (male)

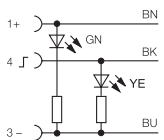
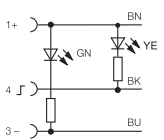
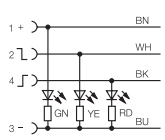
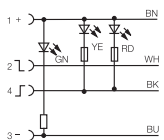
Type Code							
	Cable jacket	Description	Type	Pin	Rated current/voltage	Cable length	Wire section
	PVC	3-core angled to straight LEDPNP	CBO12.3-2-C8.3/L	3	4A/30V	2m	0.25mm ²
		3-core angled to angled LEDPNP	CBO12.3-2-CB8.3/L	3	4A/30V	2m	0.25mm ²
		4-core angled to straight LEDPNP	CBO12.4-2-C8.4/L	4	4A/30V	2m	0.25mm ²
		4-core angled to angled LEDPNP	CBO12.4-2-CB8.4/L	4	4A/30V	2m	0.25mm ²
		3-core angled to straight LEDNPN	CBO12.3-2-C8.3/LN	3	4A/30V	2m	0.25mm ²
		3-core angled to angled LEDNPN	CBO12.3-2-CB8.3/LN	3	4A/30V	2m	0.25mm ²
		4-core angled to straight LEDNPN	CBO12.4-2-C8.4/LN	4	4A/30V	2m	0.25mm ²
		4-core angled to angled LEDNPN	CBO12.4-2-CB8.4/LN	4	4A/30V	2m	0.25mm ²
	PUR	3-core angled to straight LEDPNP	CBO12.3-2-C8.3/L/P	3	4A/30V	2m	0.25mm ²
		3-core angled to angled LEDPNP	CBO12.3-2-CB8.3/L/P	3	4A/30V	2m	0.25mm ²
		4-core angled to straight LEDPNP	CBO12.4-2-C8.4/L/P	4	4A/30V	2m	0.25mm ²
		4-core angled to angled LEDPNP	CBO12.4-2-CB8.4/L/P	4	4A/30V	2m	0.25mm ²
		3-core angled to straight LEDNPN	CBO12.3-2-C8.3/LN/P	3	4A/30V	2m	0.25mm ²
		3-core angled to angled LEDNPN	CBO12.3-2-CB8.3/LN/P	3	4A/30V	2m	0.25mm ²
		4-core angled to straight LEDNPN	CBO12.4-2-C8.4/LN/P	4	4A/30V	2m	0.25mm ²
		4-core angled to angled LEDNPN	CBO12.4-2-CB8.4/LN/P	4	4A/30V	2m	0.25mm ²



Product with LED	PNP 3-core	NPN 3-core	PNP 4-core	NPN 4-core
				

Y Splitter M12-male to M12-female

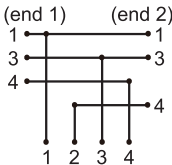
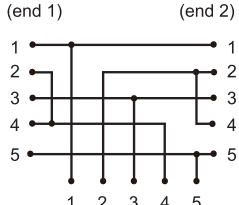
Type Code							
	Cable jacket	Description	Type	Pin	Rated current/voltage	Cable length	Wire section
	PVC	Straight to 2 straight	ECS-2CO12.4-2/2	4-3/3	4A/250V	2m	0.34mm ²
		Straight to 2 angled	ECS-2CBO12.4-2/2	4-3/3	4A/250V	2m	0.34mm ²
		Straight to 2 straight	ECS-2CO12.4-2/2/B24	4-4/4	4A/60V	2m	0.34mm ²
		Straight to 2 angled	ECS-2CBO12.4-2/2/B24	4-4/4	4A/60V	2m	0.34mm ²
	PUR	Straight to 2 straight	ECS-2CO12.4-2/2/P	4-3/3	4A/250V	2m	0.34mm ²
		Straight to 2 angled	ECS-2CBO12.4-2/2/P	4-3/3	4A/250V	2m	0.34mm ²
		Straight to 2 straight	ECS-2CO12.4-2/2/B24/P	4-4/4	4A/60V	2m	0.34mm ²
		Straight to 2 angled	ECS-2CBO12.4-2/2/B24/P	4-4/4	4A/60V	2m	0.34mm ²



Wiring Diagram	Standard	B24
		

Y Splitter M12-male to M8-female

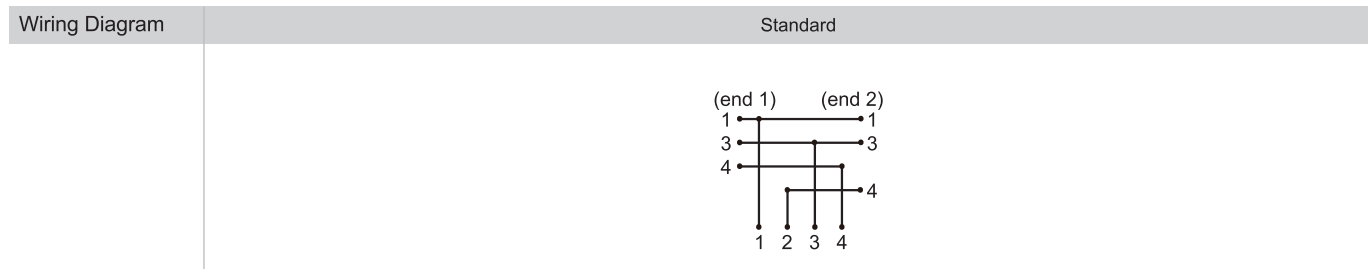
Type Code							
	Cable jacket	Description	Type	Pin	Rated current/voltage	Cable length	Wire section
	PVC	Straight to 2 straight	ECS-2CO8.3-2/2	4-3/3	4A/60V	2m	0.25mm ²
		Straight to 2 angled	ECS-2CBO8.3-2/2	4-3/3	4A/60V	2m	0.25mm ²
	PUR	Straight to 2 straight	ECS-2CO8.3-2/2/P	4-3/3	4A/60V	2m	0.25mm ²
		Straight to 2 angled	ECS-2CBO8.3-2/2/P	4-3/3	4A/60V	2m	0.25mm ²



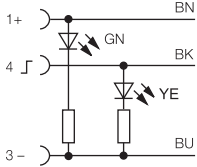
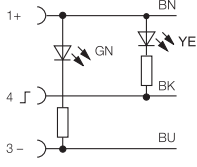

Y Splitter M12-male to M12-female

Type Code							
	Cable jacket	Description	Type	Pin	Rated current/voltage	Cable length	Wire section
	PVC	Straight to 2 straight PNP	ECS-2CO12.4-2/2/L	4-3/3	4A/30V	2m	0.34mm ²
		Straight to 2 angled PNP	ECS-2CBO12.4-2/2/L	4-3/3	4A/30V	2m	0.34mm ²
		Straight to 2 straight NPN	ECS-2CO12.4-2/2/LN	4-3/3	4A/30V	2m	0.34mm ²
		Straight to 2 angled NPN	ECS-2CBO12.4-2/2/LN	4-3/3	4A/30V	2m	0.34mm ²
	PUR	Straight to 2 straight PNP	ECS-2CO12.4-2/2/L/P	4-3/3	4A/30V	2m	0.34mm ²
		Straight to 2 angled PNP	ECS-2CBO12.4-2/2/L/P	4-3/3	4A/30V	2m	0.34mm ²
		Straight to 2 straight NPN	ECS-2CO12.4-2/2/LN/P	4-3/3	4A/30V	2m	0.34mm ²
		Straight to 2 angled NPN	ECS-2CBO12.4-2/2/LN/P	4-3/3	4A/30V	2m	0.34mm ²

Product with LED	PNP 3-core	NPN 3-core
		

Y Splitter M12-male to M8-female

Type Code							
	Cable jacket	Description	Type	Pin	Rated current/voltage	Cable length	Wire section
	PVC	Straight to 2 straight PNP	ECS-2CO8.3-2/2/L	4-3/3	4A/30V	2m	0.25mm ²
		Straight to 2 angled PNP	ECS-2CBO8.3-2/2/L	4-3/3	4A/30V	2m	0.25mm ²
		Straight to 2 straight NPN	ECS-2CO8.3-2/2/LN	4-3/3	4A/30V	2m	0.25mm ²
		Straight to 2 angled NPN	ECS-2CBO8.3-2/2/LN	4-3/3	4A/30V	2m	0.25mm ²
	PUR	Straight to 2 straight PNP	ECS-2CO8.3-2/2/L/P	4-3/3	4A/30V	2m	0.25mm ²
		Straight to 2 angled PNP	ECS-2CBO8.3-2/2/L/P	4-3/3	4A/30V	2m	0.25mm ²
		Straight to 2 straight NPN	ECS-2CO8.3-2/2/LN/P	4-3/3	4A/30V	2m	0.25mm ²
		Straight to 2 angled NPN	ECS-2CBO8.3-2/2/LN/P	4-3/3	4A/30V	2m	0.25mm ²

Product with LED

PNP 3-core

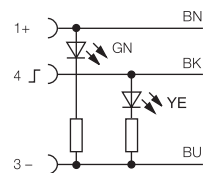

NPN 3-core

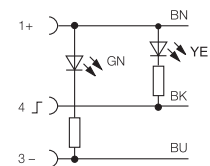

Y Splitter M12(M) to Homerun Cable

Type Code							
	Cable jacket	Description	Type	Pin	Rated current/voltage	Cable length	Wire section
	PVC	Y Splitter M12(M) to Homerun Cable	ECS-2.3-2/2	4-3/3	4A/250V	2m	0.34mm ²
	PUR	Y Splitter M12(M) to Homerun Cable	ECS-2.3-2/2/P	4-3/3	4A/250V	2m	0.34mm ²

Wiring Diagram

Standard

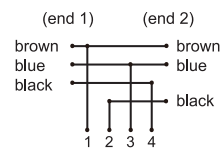

Y Adapter

Type Code						
Cable jacket	Description	Type	Pin	Rated current/voltage	Cable length	
	Standard	Universal Y adapter	ECS-CO12.3	4-3/3	4A/60V	—
	Standard	Universal Y adapter	ECS-CO8.3	4-3/3	4A/60V	—
Special	Special Y adapter	ECS-CO12.5	5-5/5	4A/60V	—	
	Special Y adapter	ECS-CO12.5/B24	5-4/4	4A/60V	—	

Dimensions

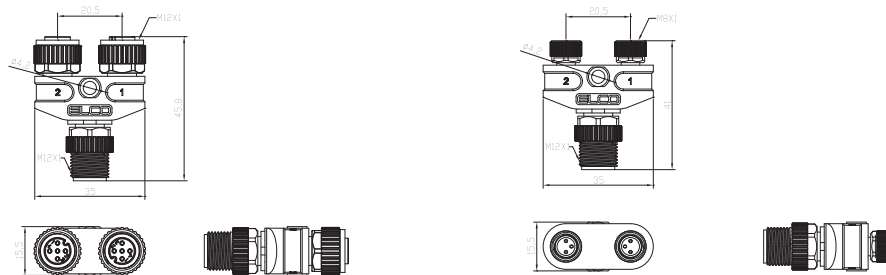

Wiring Diagram

Universal 4-3

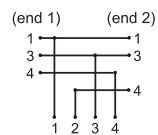

Universal 5-5

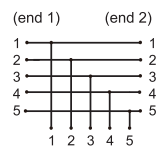

Special 5-4(B24)

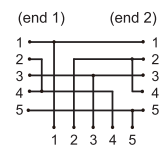

Y Adapter with Cable

Type Code							
Cable jacket	Description	Type	Pin	Rated current/voltage	Cable length	Wire section	
	M12 male straight	ECS-CO12.3-2-C12.4	4-3/3	4A/60V	2m	0.34mm ²	
	M8 male straight	ECS-CO12.3-2-C8.4	4-3/3	4A/60V	2m	0.25mm ²	
	M12 male angled	ECS-CO12.3-2-CB12.4	4-3/3	4A/60V	2m	0.34mm ²	
	M8 male angled	ECS-CO12.3-2-CB8.4	4-3/3	4A/60V	2m	0.25mm ²	
Special Y adapter PUR	M12 male straight	ECS-CO12.3-2-C12.4/P	4-3/3	4A/60V	2m	0.34mm ²	
	M8 male straight	ECS-CO12.3-2-C8.4/P	4-3/3	4A/60V	2m	0.25mm ²	
	M12 male angled	ECS-CO12.3-2-CB12.4/P	4-3/3	4A/60V	2m	0.34mm ²	
	M8 male angled	ECS-CO12.3-2-CB8.4/P	4-3/3	4A/60V	2m	0.25mm ²	

Dimensions

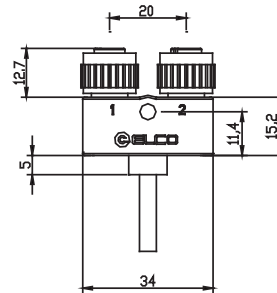

Wiring Diagram

Universal 4-3

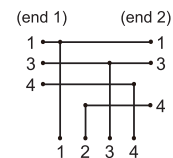

ELCO Industrie Automation GmbH

Benzstrasse 7

71720 Oberstenfeld

Deutschland

E-Mail: info@elco-automation.de



www.elco-automation.de

C+R Automations- GmbH

Nürnberger Straße 45

90513 Zirndorf

Tel. +49 (0)911 656587-0

E-Mail: info@crautomation.de

www.crautomation.de