

M9 Series



M9 Series Circular Connectors

1.Assembly connector	0901-0906
2.Connector for molding	0907-0908
3.Panel	0909-0910
4.Cable	0911-0914

C+R Automations- GmbH

Nürnberg Straße 45
90513 Zirndorf

Tel. +49 (0)911 656587-0
Fax +49 (0)911 656587-99

E-Mail: info@crautomation.de
www.crautomation.de

Änderungen vorbehalten

M9 Circular connectors

Male assembly connector

Product figure



Scale diagram

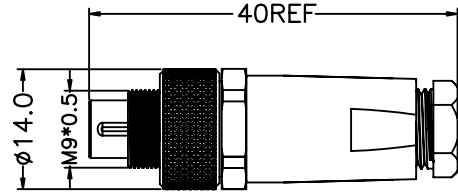

Contact layout/针孔排布(Front view/前视图)

2pins



3pins



4pins



5pins



7pins



8pins



Order data/订货信息

Contacts/芯数	Order No/订货号	P/N/料号
2pins	090002-01-001	ASM09M02001
3pins	090003-01-001	ASM09M03001
4pins	090004-01-001	ASM09M04001
5pins	090005-01-001	ASM09M05001
7pins	090007-01-001	ASM09M07001
8pins	090008-01-001	ASM09M08001

Specification/技术参数

Number of contacts/芯数	2	3	4	5	7	8
Termination/接线方式	solder/焊接					
Wire gauge/线规	0.25mm ² / 24 AWG				0.14mm ² / 26 AWG	
Cable OD/线材直径	3~4.5mm					
Operating temperature/工作温度	-25°C~+85°C					
Mechanical operation/插拔次数	> 100 mating cycles					
Rated voltage/额定电压	125V					
Rated current (40°C)/额定电流	4A		3A		1A	
Protection degree/防护等级	IP67/IP68					
Contact resistance/接触电阻	< 3mΩ					
Insulation resistance/绝缘电阻	≥100MΩ					
Pin contact/插针材料	CuZn					
Socket contact/插孔材料	CuSn					
Contact plating/针孔镀层材料	Au					

M9 Circular connectors

Female assembly connector

Product figure



Scale diagram

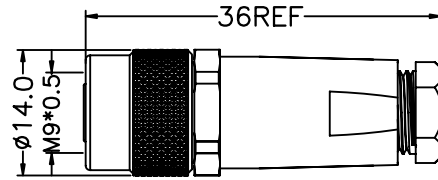

Contact layout/针孔排布(Front view/前视图)

2pins



3pins



4pins



5pins



7pins



8pins



Order data/订货信息

Contacts/芯数	Order No/订货号	P/N/料号
2pins	090002-02-001	ASM09F02001
3pins	090003-02-001	ASM09F03001
4pins	090004-02-001	ASM09F04001
5pins	090005-02-001	ASM09F05001
7pins	090007-02-001	ASM09F07001
8pins	090008-02-001	ASM09F08001

Specification/技术参数

Number of contacts/芯数	2	3	4	5	7	8
Termination/接线方式	solder/焊接					
Wire gauge/线规	0.25mm ² / 24 AWG				0.14mm ² / 26 AWG	
Cable OD/线材直径	3~4.5mm					
Operating temperature/工作温度	-25°C~+85°C					
Mechanical operation/插拔次数	> 100 mating cycles					
Rated voltage/额定电压	125V					
Rated current (40°C)/额定电流	4A			3A		1A
Protection degree/防护等级	IP67/IP68					
Contact resistance/接触电阻	< 3mΩ					
Insulation resistance/绝缘电阻	≥100MΩ					
Pin contact/插针材料	CuZn					
Socket contact/插孔材料	CuSn					
Contact plating/针孔镀层材料	Au					

M9 Circular connectors

Male assembly connector

Product figure



Scale diagram

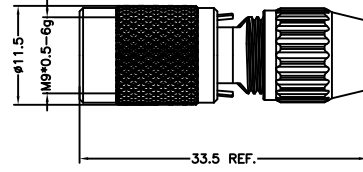

Contact layout/针孔排布(Front view/前视图)

2pins



3pins



4pins



5pins



7pins



8pins



Order data/订货信息

Contacts/芯数	Order No/订货号	P/N/料号
2pins	090002-01-004	—
3pins	090003-01-004	—
4pins	090004-01-006	—
5pins	090005-01-004	—
7pins	090007-01-004	—
8pins	090008-01-006	—

Specification/技术参数

Number of contacts/芯数	2	3	4	5	7	8
Termination/接线方式	solder/焊接					
Wire gauge/线规	0.25mm ² / 24 AWG				0.14mm ² / 26 AWG	
Cable OD/线材直径	3~5mm					
Operating temperature/工作温度	-25°C~+85°C					
Mechanical operation/插拔次数	> 100 mating cycles					
Rated voltage/额定电压	125V					
Rated current (40°C)/额定电流	4A		3A		1A	
Protection degree/防护等级	IP67/IP68					
Contact resistance/接触电阻	< 3mΩ					
Insulation resistance/绝缘电阻	≥100MΩ					
Pin contact/插针材料	CuZn					
Socket contact/插孔材料	CuSn					
Contact plating/针孔镀层材料	Au					

Female assembly connector

Product figure



Scale diagram

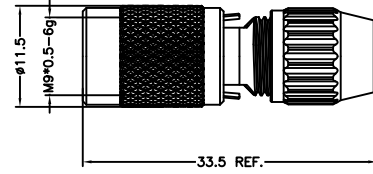

Contact layout/针孔排布(Front view/前视图)

2pins



3pins



4pins



5pins



7pins



8pins



Order data/订货信息

Contacts/芯数	Order No/订货号	P/N/料号
2pins	090002-02-002	—
3pins	090003-02-002	—
4pins	090004-02-003	—
5pins	090005-02-003	—
7pins	090007-02-002	—
8pins	090008-02-002	—

Specification/技术参数

Number of contacts/芯数	2	3	4	5	7	8
Termination/接线方式	solder/焊接					
Wire gauge/线规	0.25mm ² / 24 AWG			0.14mm ² / 26 AWG		
Cable OD/线材直径	3~5mm					
Operating temperature/工作温度	-25°C~+85°C					
Mechanical operation/插拔次数	> 100 mating cycles					
Rated voltage/额定电压	125V					
Rated current (40°C)/额定电流	4A		3A		1A	
Protection degree/防护等级	IP67/IP68					
Contact resistance/接触电阻	< 3mΩ					
Insulation resistance/绝缘电阻	≥100MΩ					
Pin contact/插针材料	CuZn					
Socket contact/插孔材料	CuSn					
Contact plating/针孔镀层材料	Au					

M9 Circular connectors

Male assembly connector

Product figure



Scale diagram

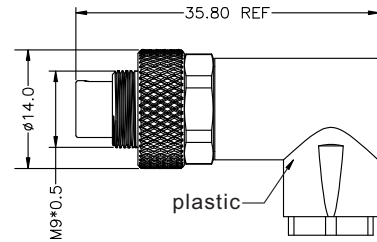

Contact layout/针孔排布(Front view/前视图)

2pins



3pins



4pins



5pins



7pins



8pins



Order data/订货信息

Contacts/芯数	Order No/订货号	P/N/料号
2pins	090002-01-003	—
3pins	090003-01-003	—
4pins	090004-01-005	—
5pins	090005-01-003	—
7pins	090007-01-003	—
8pins	090008-01-002	—

Specification/技术参数

Number of contacts/芯数	2	3	4	5	7	8
Termination/接线方式	solder/焊接					
Wire gauge/线规	0.25mm ² / 24 AWG				0.14mm ² / 26 AWG	
Cable OD/线材直径	3~4.5mm					
Operating temperature/工作温度	-25°C~+85°C					
Mechanical operation/插拔次数	> 100 mating cycles					
Rated voltage/额定电压	125V					
Rated current (40°C)/额定电流	4A		3A		1A	
Protection degree/防护等级	IP67/IP68					
Contact resistance/接触电阻	< 3mΩ					
Insulation resistance/绝缘电阻	≥100MΩ					
Pin contact/插针材料	CuZn					
Socket contact/插孔材料	CuSn					
Contact plating/针孔镀层材料	Au					

Male assembly connector

Product figure



Scale diagram

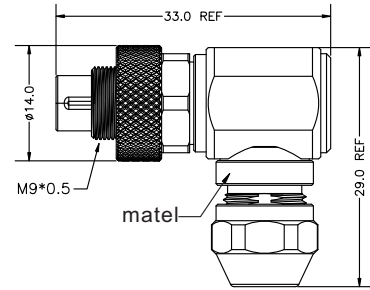

Contact layout/针孔排布(Front view/前视图)

2pins



3pins



4pins



5pins



7pins



8pins



Order data/订货信息

Contacts/芯数	Order No/订货号	P/N/料号
2pins	090002-01-002	—
3pins	090003-01-002	—
4pins	090004-01-004	—
5pins	090005-01-002	—
7pins	090007-01-002	—
8pins	090008-01-005	—

Specification/技术参数

Number of contacts/芯数	2	3	4	5	7	8
Termination/接线方式	solder/焊接					
Wire gauge/线规	0.25mm ² / 24 AWG				0.14mm ² / 26 AWG	
Cable OD/线材直径	3~4.5mm					
Operating temperature/工作温度	-25°C~+85°C					
Mechanical operation/插拔次数	> 100 mating cycles					
Rated voltage/额定电压	125V					
Rated current (40°C)/额定电流	4A			3A		1A
Protection degree/防护等级	IP67/IP68					
Contact resistance/接触电阻	< 3mΩ					
Insulation resistance/绝缘电阻	≥100MΩ					
Pin contact/插针材料	CuZn					
Socket contact/插孔材料	CuSn					
Contact plating/针孔镀层材料	Au					

M9 Circular connectors

Male connector for molding

Product figure



Scale diagram

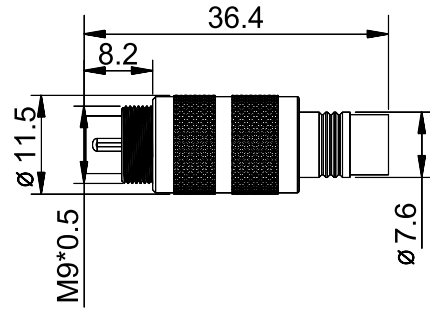

Contact layout/针孔排布(Front view/前视图)

2pins



3pins



4pins



5pins



7pins



8pins



Order data/订货信息

Contacts/芯数	Order No/订货号	P/N/料号
2pins	090002-20-001	M09M02001
3pins	090003-20-001	M09M03001
4pins	090004-20-001	M09M04001
5pins	090005-20-001	M09M05001
7pins	090007-20-001	M09M07001
8pins	090008-20-001	M09M08001

Specification/技术参数

Number of contacts/芯数	2	3	4	5	7	8
Termination/接线方式	solder/焊接					
Wire gauge/线规	0.25mm ² / 24 AWG			0.14mm ² / 26 AWG		
Operating temperature/工作温度	-25°C ~ +85°C					
Mechanical operation/插拔次数	> 100 mating cycles					
Rated voltage/额定电压	125V					
Rated current (40°C)/额定电流	4A		3A		1A	
Protection degree/防护等级	IP67/IP68					
Contact resistance/接触电阻	< 3mΩ					
Insulation resistance/绝缘电阻	≥100MΩ					
Pin contact/插针材料	CuZn					
Socket contact/插孔材料	CuSn					
Contact plating/针孔镀层材料	Au					

Female connector for molding

Product figure



Scale diagram

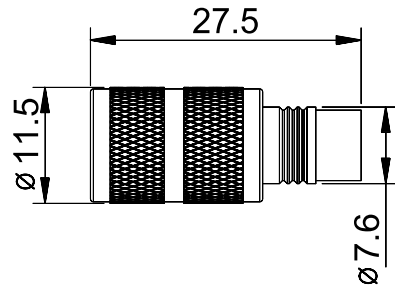

Contact layout/针孔排布(Front view/前视图)

2pins



3pins



4pins



5pins



7pins



8pins



Order data/订货信息

Contacts/芯数	Order No/订货号	P/N/料号
2pins	090002-21-001	M09F02001
3pins	090003-21-001	M09F03001
4pins	090004-21-001	M09F04001
5pins	090005-21-001	M09F05001
7pins	090007-21-001	M09F07001
8pins	090008-21-001	M09F08001

Specification/技术参数

Number of contacts/芯数	2	3	4	5	7	8
Termination/接线方式	solder/焊接					
Wire gauge/线规	0.25mm ² / 24 AWG			0.14mm ² / 26 AWG		
Operating temperature/工作温度	-25°C ~ +85°C					
Mechanical operation/插拔次数	> 100 mating cycles					
Rated voltage/额定电压	125V					
Rated current (40°C)/额定电流	4A		3A		1A	
Protection degree/防护等级	IP67/IP68					
Contact resistance/接触电阻	< 3mΩ					
Insulation resistance/绝缘电阻	≥100MΩ					
Pin contact/插针材料	CuZn					
Socket contact/插孔材料	CuSn					
Contact plating/针孔镀层材料	Au					

M9 Circular connectors

Male panel connector

Product figure (front fastened)



Scale diagram

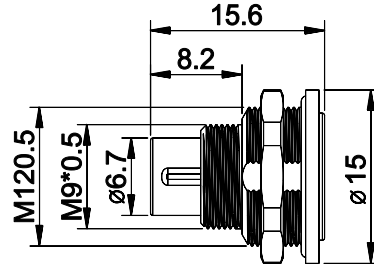

Contact layout/针孔排布(Front view/前视图)

2pins



3pins



4pins



5pins



7pins



8pins



Order data/订货信息

Contacts/芯数	Order No/订货号	P/N/料号
2pins	090002-03-001	PMM09FM02001
3pins	090003-03-001	PMM09FM03001
4pins	090004-03-001	PMM09FM04001
5pins	090005-03-001	PMM09FM05001
7pins	090007-03-001	PMM09FM07001
8pins	090008-03-001	PMM09FM08001

Specification/技术参数

Number of contacts/芯数	2	3	4	5	7	8
Termination/接线方式	solder/焊接					
Wire gauge/线规	0.25mm ² / 24 AWG			0.14mm ² / 26 AWG		
Operating temperature/工作温度	-25°C ~ +85°C					
Mechanical operation/插拔次数	> 100 mating cycles					
Rated voltage/额定电压	125V					
Rated current (40°C)/额定电流	4A		3A		1A	
Protection degree/防护等级	IP67/IP68					
Contact resistance/接触电阻	< 3mΩ					
Insulation resistance/绝缘电阻	≥100MΩ					
Pin contact/插针材料	CuZn					
Socket contact/插孔材料	CuSn					
Contact plating/针孔镀层材料	Au					

Female panel connector

Product figure (front fastened)



Scale diagram

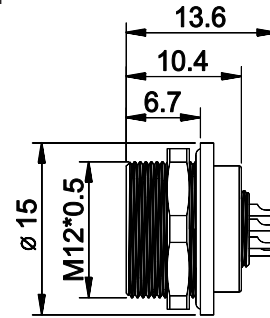

Contact layout/针孔排布(Front view/前视图)

2pins



3pins



4pins



5pins



7pins



8pins



Order data/订货信息

Contacts/芯数	Order No/订货号	P/N/料号
2pins	090002-04-001	PMM09FF02001
3pins	090003-04-001	PMM09FF03001
4pins	090004-04-001	PMM09FF04001
5pins	090005-04-001	PMM09FF05001
7pins	090007-04-001	PMM09FF07001
8pins	090008-04-001	PMM09FF08001

Specification/技术参数

Number of contacts/芯数	2	3	4	5	7	8
Termination/接线方式	solder/焊接					
Wire gauge/线规	0.25mm ² / 24 AWG				0.14mm ² / 26 AWG	
Operating temperature/工作温度	-25°C ~ +85°C					
Mechanical operation/插拔次数	> 100 mating cycles					
Rated voltage/额定电压	125V					
Rated current (40°C)/额定电流	4A		3A		1A	
Protection degree/防护等级	IP67/IP68					
Contact resistance/接触电阻	< 3mΩ					
Insulation resistance/绝缘电阻	≥100MΩ					
Pin contact/插针材料	CuZn					
Socket contact/插孔材料	CuSn					
Contact plating/针孔镀层材料	Au					

M9 Circular connectors

Male cable moulded

Product figure



Scale diagram

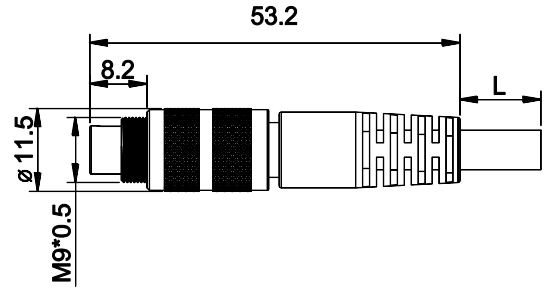

Contact layout/针孔排布(Front view/前视图)

2pins



3pins



4pins



5pins



7pins



8pins



Order data/订货信息

Contacts/芯数	Order No/订货号	P/N/料号
2pins	090002-05-001	CAM09SM02001
3pins	090003-05-001	CAM09SM03001
4pins	090004-05-001	CAM09SM04001
5pins	090005-05-001	CAM09SM05001
7pins	090007-05-001	CAM09SM07001
8pins	090008-05-001	CAM09SM08001

Specification/技术参数

Number of contacts/芯数	2	3	4	5	7	8
Termination/接线方式	moulded on cable/成型线					
Wire gauge/线规	0.25mm ² / 24 AWG				0.14mm ² / 26 AWG	
Operating temperature/工作温度	-25°C ~ +80°C					
Mechanical operation/插拔次数	> 100 mating cycles					
Rated voltage/额定电压	125V					
Rated current (40°C)/额定电流	4A		3A		1A	
Protection degree/防护等级	IP67/IP68					
Contact resistance/接触电阻	< 3mΩ					
Insulation resistance/绝缘电阻	≥100MΩ					
Pin contact/插针材料	CuZn					
Socket contact/插孔材料	CuSn					
Contact plating/针孔镀层材料	Au					

Female cable moulded

Product figure



Scale diagram

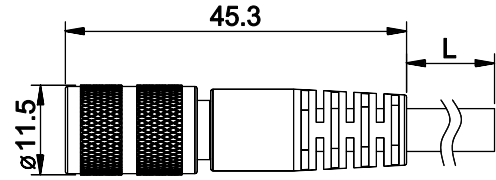

Contact layout/针孔排布(Front view/前视图)

2pins



3pins



4pins



5pins



7pins



8pins



Order data/订货信息

Contacts/芯数	Order No/订货号	P/N/料号
2pins	090003-06-001	CAM09SF02001
3pins	090003-06-001	CAM09SF03001
4pins	090004-06-001	CAM09SF04001
5pins	090005-06-001	CAM09SF05001
7pins	090007-06-001	CAM09SF07001
8pins	090008-06-001	CAM09SF08001

Specification/技术参数

Number of contacts/芯数	2	3	4	5	7	8
Termination/接线方式	moulded on cable/成型线					
Wire gauge/线规	0.25mm ² / 24 AWG			0.14mm ² / 26 AWG		
Operating temperature/工作温度	-25°C ~ +80°C					
Mechanical operation/插拔次数	> 100 mating cycles					
Rated voltage/额定电压	125V					
Rated current (40°C)/额定电流	4A		3A		1A	
Protection degree/防护等级	IP67/IP68					
Contact resistance/接触电阻	< 3mΩ					
Insulation resistance/绝缘电阻	≥100MΩ					
Pin contact/插针材料	CuZn					
Socket contact/插孔材料	CuSn					
Contact plating/针孔镀层材料	Au					

M9 Circular connectors

Male cable moulded

Product figure



Scale diagram

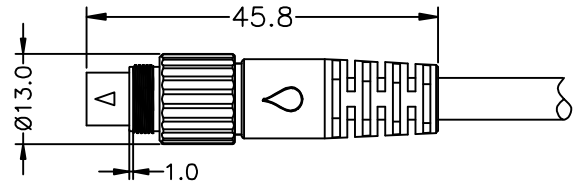

Contact layout/针孔排布(Front view/前视图)

2pins



3pins



4pins



5pins



7pins



8pins



Order data/订货信息

Contacts/芯数	Order No/订货号	P/N/料号
2pins	090002-05-003	CAM09SM02003
3pins	090003-05-003	CAM09SM03003
4pins	090004-05-003	CAM09SM04003
5pins	090005-05-004	CAM09SM05003
7pins	090007-05-003	CAM09SM07003
8pins	090008-05-012	CAM09SM08003

Specification/技术参数

Number of contacts/芯数	2	3	4	5	7	8
Termination/接线方式	moulded on cable/成型线					
Wire gauge/线规	0.25mm ² / 24 AWG				0.14mm ² / 26 AWG	
Operating temperature/工作温度	-25°C ~ +80°C					
Mechanical operation/插拔次数	> 100 mating cycles					
Rated voltage/额定电压	125V					
Rated current (40°C)/额定电流	4A		3A		1A	
Protection degree/防护等级	IP67/IP68					
Contact resistance/接触电阻	< 3mΩ					
Insulation resistance/绝缘电阻	≥100MΩ					
Pin contact/插针材料	CuZn					
Socket contact/插孔材料	CuSn					
Contact plating/针孔镀层材料	Au					

Male cable moulded(90°)

Product figure



Scale diagram

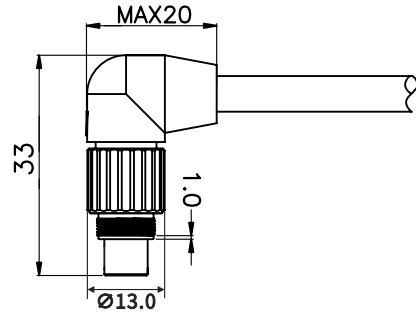

Contact layout/针孔排布(Front view/前视图)

2pins



3pins



4pins



5pins



7pins



8pins



Order data/订货信息

Contacts/芯数	Order No/订货号	P/N/料号
2pins	090002-05-002	CAM09RM02002
3pins	090003-05-002	CAM09RM03002
4pins	090004-05-002	CAM09RM04002
5pins	090005-05-002	CAM09RM05002
7pins	090007-05-002	CAM09RM07002
8pins	090008-05-007	CAM09RM08002

Specification/技术参数

Number of contacts/芯数	2	3	4	5	7	8
Termination/接线方式	moulded on cable/成型线					
Wire gauge/线规	0.25mm ² / 24 AWG			0.14mm ² / 26 AWG		
Operating temperature/工作温度	-25°C ~ +80°C					
Mechanical operation/插拔次数	> 100 mating cycles					
Rated voltage/额定电压	125V					
Rated current (40°C)/额定电流	4A		3A		1A	
Protection degree/防护等级	IP67/IP68					
Contact resistance/接触电阻	< 3mΩ					
Insulation resistance/绝缘电阻	≥100MΩ					
Pin contact/插针材料	CuZn					
Socket contact/插孔材料	CuSn					
Contact plating/针孔镀层材料	Au					