

M8 Series



M8 Series Circular Connectors

1.Assembly connector

0801-0808

2.Connector for over-molding

0809-0812

3.Panel

0813-0826

4.Cable

0827-0833

5.Adapter

0834-0840

6.M8 P-coding

0841-0843

6.Standard cable length

0844-0881

C+R Automations- GmbH

Nürnberger Straße 45
90513 Zirndorf

Tel. +49 (0)911 656587-0
Fax +49 (0)911 656587-99

E-Mail: info@crautomation.de
www.crautomation.de

Änderungen vorbehalten

M8 Circular connectors

Male assembly connector

Product figure



Scale diagram

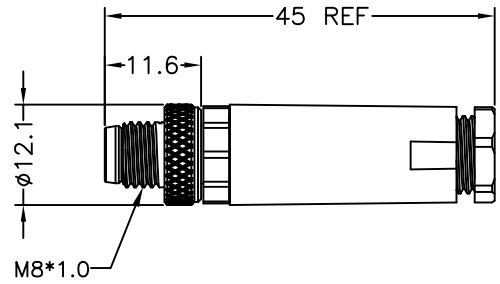

Contact layout/针孔排布 (Front view/前视图)

3pins

4pins

A

A



Order data/订货信息

Contacts/芯数	Coding	Order No/订货号	P/N/料号
3pins	A	080103-01-001S	ASM08AM03001
4pins	A	080104-01-001S	ASM08AM04001

Specifications/技术参数

Number of contacts/芯数	3	4
Termination/接线方式	screw clamp/锁螺丝	
Wire gauge/线规	0.14/0.25/0.34 mm ² / (26/24/22 AWG)	
Cable OD/线材直径	3~4.5mm	
Operating temperature/工作温度	-25°C~+85°C	
Mechanical operation/插拔次数	> 100 mating cycles	
Rated voltage/额定电压	50V AC / 60V DC	
Rated current (40°C)/额定电流	3A	
Protection degree/防护等级	IP67/IP68	
Contact resistance/接触电阻	< 10mΩ	
Insulation resistance/绝缘电阻	≥100MΩ	
Pin contact/插针材料	CuZn	
Socket contact/插孔材料	CuSn	
Contact plating/针孔镀层材料	Au	

Female assembly connector

Product figure



Scale diagram

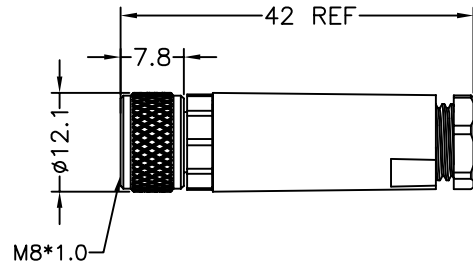

Contact layout/针孔排布 (Front view/前视图)

3pins

4pins

A

A



Order data/订货信息

Contacts/芯数	Coding	Order No/订货号	P/N/料号
3pins	A	080103-02-001S	ASM08AF03001
4pins	A	080104-02-001S	ASM08AF04001

Specifications/技术参数

Number of contacts/芯数	3	4
Termination/接线方式	screw clamp/锁螺丝	
Wire gauge/线规	0.14/0.25/0.34 mm ² / (26/24/22 AWG)	
Cable OD/线材直径	3~4.5mm	
Operating temperature/工作温度	-25°C~+85°C	
Mechanical operation/插拔次数	> 100 mating cycles	
Rated voltage/额定电压	50V AC / 60V DC	
Rated current (40°C)/额定电流	3A	
Protection degree/防护等级	IP67/IP68	
Contact resistance/接触电阻	< 10mΩ	
Insulation resistance/绝缘电阻	≥100MΩ	
Pin contact/插针材料	CuZn	
Socket contact/插孔材料	CuSn	
Contact plating/针孔镀层材料	Au	

M8 Circular connectors

Male assembly connector

Product figure

Scale diagram

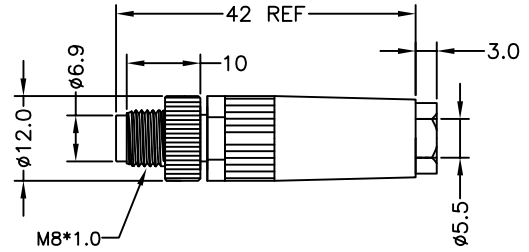

Contact layout/针孔排布 (Front view/前视图)

3pins

4pins

4pins

6pins

8pins

5pins

A

A

A

A

A

B



Order data/订货信息

Contacts/芯数	Coding	Order No/订货号	P/N/料号
3pins	A	080103-01-002	ASM08AM03002
4pins	A	080104-01-002	ASM08AM04002
	A(fool-proof)	080104-01-006	ASM08AM04006
5pins	B	080205-01-001	ASM08BM05002
6pins	A	080106-01-001	ASM08AM06002
8pins	A	080108-01-001	ASM08AM08002

Specifications/技术参数

Number of contacts/芯数	3	4	5	6	8
Termination/接线方式	solder/焊接				
Wire gauge/线规	0.14/0.25/0.34 mm ² / (26/24/22 AWG)				
Cable OD/线材直径	3~4.5mm				
Operating temperature/工作温度	-25°C~+85°C				
Mechanical operation/插拔次数	> 100 mating cycles				
Rated voltage/额定电压	50V AC / 60V DC			30V	
Rated current (40°C)/额定电流	3A			1.5A	
Protection degree/防护等级	IP67/IP68				
Contact resistance/接触电阻	< 10mΩ				
Insulation resistance/绝缘电阻	≥100MΩ				
Pin contact/插针材料	CuZn				
Socket contact/插孔材料	CuSn				
Contact plating/针孔镀层材料	Au				

M8 Circular connectors

Female assembly connector

Product figure



Scale diagram

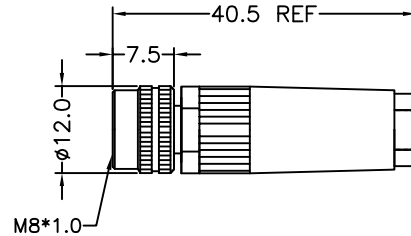

Contact layout/针孔排布 (Front view/前视图)

3pins

A



4pins

A



4pins

A



6pins

A



8pins

A



5pins

B



Order data/订货信息

Contacts/芯数	Coding	Order No/订货号	P/N/料号
3pins	A	080103-02-002	ASM08AF03002
4pins	A	080104-02-002	ASM08AF04002
	A(fool-proof)	080104-02-006	ASM08AF04006
5pins	B	080205-02-001	ASM08BF05002
6pins	A	080106-02-001	ASM08AF06002
8pins	A	080108-02-001	ASM08AF08002

Specifications/技术参数

Number of contacts/芯数	3	4	5	6	8
Termination/接线方式	solder/焊接				
Wire gauge/线规	0.14/0.25/0.34 mm ² / (26/24/22 AWG)				
Cable OD/线材直径	3~4.5mm				
Operating temperature/工作温度	-25°C~+85°C				
Mechanical operation/插拔次数	> 100 mating cycles				
Rated voltage/额定电压	50V AC / 60V DC			30V	
Rated current (40°C)/额定电流	3A			1.5A	
Protection degree/防护等级	IP67/IP68				
Contact resistance/接触电阻	< 10mΩ				
Insulation resistance/绝缘电阻	≥100MΩ				
Pin contact/插针材料	CuZn				
Socket contact/插孔材料	CuSn				
Contact plating/针孔镀层材料	Au				

M8 Circular connectors

Male assembly connector

Product figure



Scale diagram

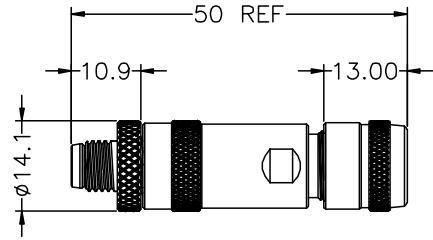

Contact layout/针孔排布 (Front view/前视图)

3pins

4pins

A

A



Order data/订货信息

Contacts/芯数	Coding	Order No/订货号	Cable OD/线材直径
3pins	A	080103-01-004S	3~4.5mm
		080103-01-008	5~7.2mm
4pins	A	080104-01-004S	3~4.5mm
		080104-01-009	5~7.2mm

Specifications/技术参数

Number of contacts/芯数	3	4
Termination/接线方式	screw clamp/锁螺丝	
Wire gauge/线规	0.14/0.25/0.34 mm ² / (26/24/22 AWG)	
Cable OD/线材直径	3~4.5mm, 5~7.2mm	
Operating temperature/工作温度	-25°C ~ +85°C	
Mechanical operation/插拔次数	> 100 mating cycles	
Rated voltage/额定电压	50V AC / 60V DC	
Rated current (40°C)/额定电流	3A	
Protection degree/防护等级	IP65	
Contact resistance/接触电阻	< 10mΩ	
Insulation resistance/绝缘电阻	≥ 100MΩ	
Pin contact/插针材料	CuZn	
Socket contact/插孔材料	CuSn	
Contact plating/针孔镀层材料	Au	

Female assembly connector

Product figure



Scale diagram

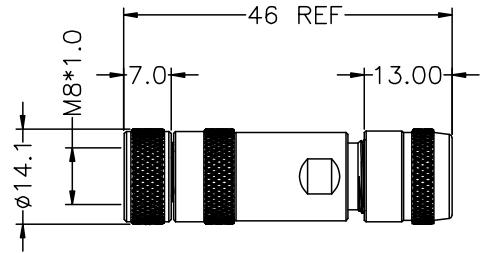

Contact layout/针孔排布 (Front view/前视图)

3pins

4pins

A

A



Order data/订货信息

Contacts/芯数	Coding	Order No/订货号	Cable OD/线材直径
3pins	A	080103-02-004S	3~4.5mm
		080103-02-009	5~7.2mm
4pins	A	080104-02-004S	3~4.5mm
		080104-02-010	5~7.2mm

Specifications/技术参数

Number of contacts/芯数	3	4
Termination/接线方式	screw clamp/锁螺丝	
Wire gauge/线规	0.14/0.25/0.34 mm ² / (26/24/22 AWG)	
Cable OD/线材直径	3~4.5mm, 5~7.2mm	
Operating temperature/工作温度	-25°C ~ +85°C	
Mechanical operation/插拔次数	> 100 mating cycles	
Rated voltage/额定电压	50V AC / 60V DC	
Rated current (40°C)/额定电流	3A	
Protection degree/防护等级	IP65	
Contact resistance/接触电阻	< 10mΩ	
Insulation resistance/绝缘电阻	≥ 100MΩ	
Pin contact/插针材料	CuZn	
Socket contact/插孔材料	CuSn	
Contact plating/针孔镀层材料	Au	

M8 Circular connectors

Male assembly connector

Product figure



Scale diagram

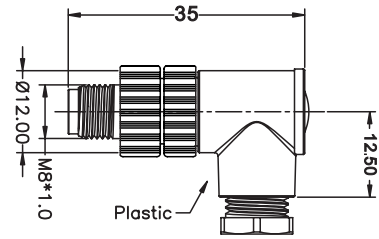

Contact layout/针孔排布 (Front view/前视图)

3pins

4pins

A

A



Order data/订货信息

Contacts/芯数	Coding	Order No/订货号	P/N/料号
3pins	A	080103-01-003	ASM08AM03003
4pins	A	080104-01-003	ASM08AM04003

Specifications/技术参数

Number of contacts/芯数	3	4
Termination/接线方式	screw clamp/锁螺丝	
Wire gauge/线规	0.14/0.25/0.34 mm ² / (26/24/22 AWG)	
Cable OD/线材直径	3~4.5mm	
Operating temperature/工作温度	-25°C~+85°C	
Mechanical operation/插拔次数	> 100 mating cycles	
Rated voltage/额定电压	50V AC / 60V DC	
Rated current (40°C)/额定电流	3A	
Protection degree/防护等级	IP65	
Contact resistance/接触电阻	< 10mΩ	
Insulation resistance/绝缘电阻	≥100MΩ	
Pin contact/插针材料	CuZn	
Socket contact/插孔材料	CuSn	
Contact plating/针孔镀层材料	Au	

Female assembly connector

Product figure



Scale diagram

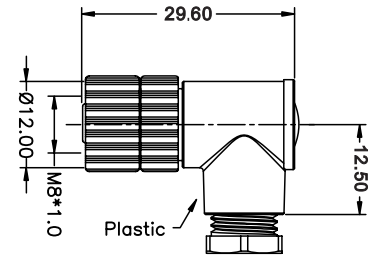

Contact layout/针孔排布 (Front view/前视图)

3pins

4pins

A

A



Order data/订货信息

Contacts/芯数	Coding	Order No/订货号	P/N/料号
3pins	A	080103-02-003	ASM08AF03003
4pins	A	080104-02-003	ASM08AF04003

Specifications/技术参数

Number of contacts/芯数	3	4
Termination/接线方式	screw clamp/锁螺丝	
Wire gauge/线规	0.14/0.25/0.34 mm ² / (26/24/22 AWG)	
Cable OD/线材直径	3~4.5mm	
Operating temperature/工作温度	-25°C~+85°C	
Mechanical operation/插拔次数	> 100 mating cycles	
Rated voltage/额定电压	50V AC / 60V DC	
Rated current (40°C)/额定电流	3A	
Protection degree/防护等级	IP65	
Contact resistance/接触电阻	< 10mΩ	
Insulation resistance/绝缘电阻	≥100MΩ	
Pin contact/插针材料	CuZn	
Socket contact/插孔材料	CuSn	
Contact plating/针孔镀层材料	Au	

M8 Circular connectors

Male connector for over-molding

Product figure



Scale diagram

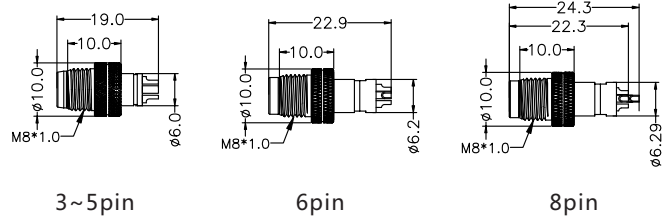

Contact layout/针孔排布 (Front view/前视图)

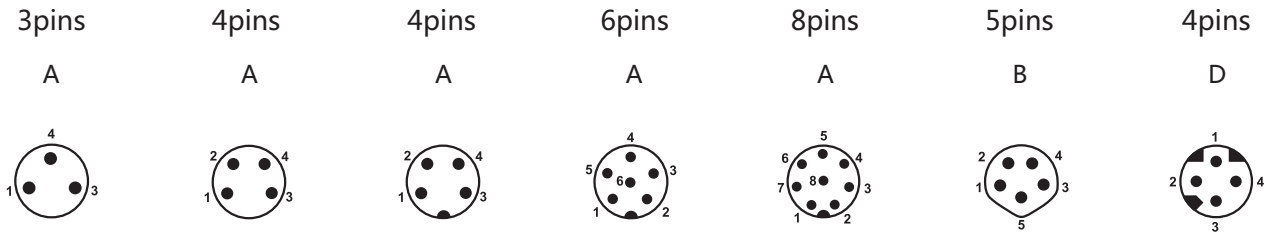

Order data/订货信息

Contacts/芯数	Coding	Order No/订货号	P/N/料号
3pins	A	080103-20-001	M08AM03001
4pins	A	080104-20-001	M08AM04001
	A(fool-proof)	080104-20-002	M08AM04002
	D	080404-20-001	M08DM04001
5pins	B	080205-20-002	M08BM05001
6pins	A	080106-20-001	M08AM06001
8pins	A	080108-20-001	M08AM08001

Specifications/技术参数

Number of contacts/芯数	3	4 A-coding	4 D-coding	5	6	8
Termination/接线方式	solder/焊线式					
Wire gauge/线规	0.14/0.25/0.34 mm ² / (26/24/22 AWG)					
Operating temperature/工作温度	-25°C ~ +80°C					
Mechanical operation/插拔次数	> 100 mating cycles					
Rated voltage/额定电压	50V AC / 60V DC		60V	30V		
Rated current (40°C)/额定电流	3A		4A	3A	1.5A	
Protection degree/防护等级	IP67/IP68					
Contact resistance/接触电阻	< 10mΩ					
Insulation resistance/绝缘电阻	≥ 100MΩ					
Pin contact/插针材料	CuZn					
Socket contact/插孔材料	CuSn					
Contact plating/针孔镀层材料	Au					

Female connector for over-molding

Product figure



Scale diagram

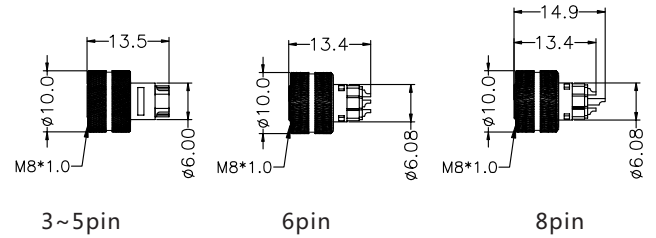

Contact layout/针孔排布 (Front view/前视图)

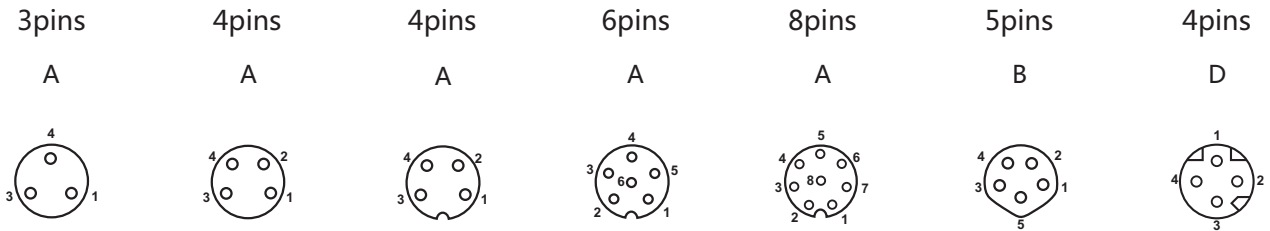

Order data/订货信息

Contacts/芯数	Coding	Order No/订货号	P/N/料号
3pins	A	080103-21-001	M08AF03001
4pins	A	080104-21-001	M08AF04001
	A(fool-proof)	080104-21-002	M08AF04002
	D	080404-21-001	M08DF04001
5pins	B	080205-21-002	M08BF05001
6pins	A	080106-21-001	M08AF06001
8pins	A	080108-21-001	M08AF08001

Specifications/技术参数

Number of contacts/芯数	3	4 A-coding	4 D-coding	5	6	8
Termination/接线方式	solder/焊线式					
Wire gauge/线规	0.14/0.25/0.34 mm ² / (26/24/22 AWG)					
Operating temperature/工作温度	-25°C ~ +80°C					
Mechanical operation/插拔次数	> 100 mating cycles					
Rated voltage/额定电压	50V AC / 60V DC		60V	30V		
Rated current (40°C)/额定电流	3A		4A	3A	1.5A	
Protection degree/防护等级	IP67/IP68					
Contact resistance/接触电阻	< 10mΩ					
Insulation resistance/绝缘电阻	≥100MΩ					
Pin contact/插针材料	CuZn					
Socket contact/插孔材料	CuSn					
Contact plating/针孔镀层材料	Au					

M8 Circular connectors

Male connector for over-molding

Product figure (with shield)



Scale diagram

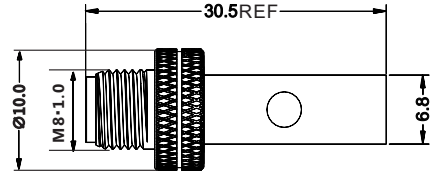

Contact layout/针孔排布 (Front view/前视图)

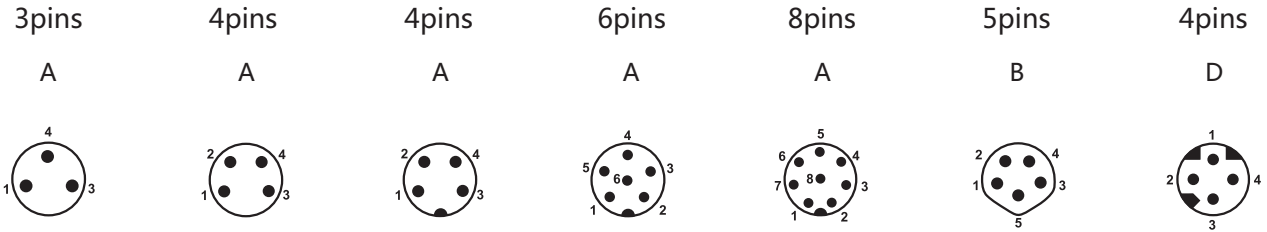

Order data/订货信息

Contacts/芯数	Coding	Order No/订货号	P/N/料号
3pins	A	080103-20-002	M08AM03002
4pins	A	080104-20-003	M08AM04003
	A(fool-proof)	080104-20-004	M08AM04004
	D	080404-20-002	M08DM04002
	B	080205-20-003	M08BM05002
6pins	A	080106-20-002	M08AM06002
8pins	A	080108-20-002	M08PM04002

Specifications/技术参数

Number of contacts/芯数	3	4 A-coding	4 D-coding	5	6	8
Termination/接线方式	solder/焊线式					
Wire gauge/线规	0.14/0.25/0.34 mm ² / (26/24/22 AWG)					
Operating temperature/工作温度	-25°C ~ +80°C					
Mechanical operation/插拔次数	> 100 mating cycles					
Rated voltage/额定电压	50V AC / 60V DC		60V	30V		
Rated current (40°C)/额定电流	3A		4A	3A	1.5A	
Protection degree/防护等级	IP67/IP68					
Contact resistance/接触电阻	< 10mΩ					
Insulation resistance/绝缘电阻	≥100MΩ					
Pin contact/插针材料	CuZn					
Socket contact/插孔材料	CuSn					
Contact plating/针孔镀层材料	Au					

Female connector for over-molding

Product figure (with shield)



Scale diagram

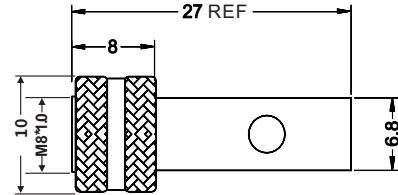

Contact layout/针孔排布 (Front view/前视图)

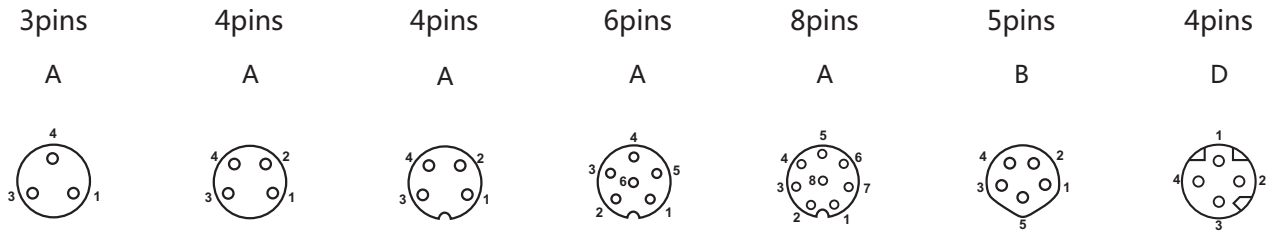

Order data/订货信息

Contacts/芯数	Coding	Order No/订货号	P/N/料号
3pins	A	080103-21-002	M08AF03002
4pins	A	080104-21-003	M08AF04003
	A(fool-proof)	080104-21-004	M08AF04004
	D	080404-21-002	M08DF04002
5pins	B	080205-21-003	M08BF05002
6pins	A	080106-21-002	M08AF06002
8pins	A	080108-21-002	M08AF08002

Specifications/技术参数

Number of contacts/芯数	3	4 A-coding	4 D-coding	5	6	8
Termination/接线方式	solder/焊线式					
Wire gauge/线规	0.14/0.25/0.34 mm ² / (26/24/22 AWG)					
Operating temperature/工作温度	-25°C ~ +80°C					
Mechanical operation/插拔次数	> 100 mating cycles					
Rated voltage/额定电压	50V AC / 60V DC		60V	30V		
Rated current (40°C)/额定电流	3A		4A	3A	1.5A	
Protection degree/防护等级	IP67/IP68					
Contact resistance/接触电阻	< 10mΩ					
Insulation resistance/绝缘电阻	≥100MΩ					
Pin contact/插针材料	CuZn					
Socket contact/插孔材料	CuSn					
Contact plating/针孔镀层材料	Au					

M8 Circular connectors

Male panel connector

Product figure (rear fastened solder)

Scale diagram

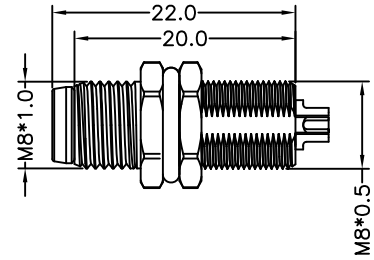

Contact layout/针孔排布 (Front view/前视图)

3pins

4pins

4pins

6pins

8pins

5pins

4pins

A

A

A

A

A

B

D

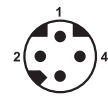
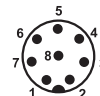

Order data/订货信息

Contacts/芯数	Coding	Order No/订货号	P/N/料号
3pins	A	080103-03-001	PMM08BAM03001
4pins	A	080104-03-001	PMM08BAM04001
	A(fool-proof)	080104-03-009	PMM08BAM04005
	D	080404-03-001	PMM08BDM04001
5pins	B	080205-03-001	PMM08BBM05001
6pins	A	080106-03-001	PMM08BAM06001
8pins	A	080108-03-001	PMM08BAM08001

Specifications/技术参数

Number of contacts/芯数	3	4 A-coding	4 D-coding	5	6	8
Termination/接线方式	solder/焊线式					
Wire gauge/线规	0.14/0.25/0.34 mm ² / (26/24/22 AWG)					
Operating temperature/工作温度	-25°C ~ +80°C					
Mechanical operation/插拔次数	> 100 mating cycles					
Rated voltage/额定电压	50V AC / 60V DC		60V	30V		
Rated current (40°C)/额定电流	3A		4A	3A	1.5A	
Protection degree/防护等级	IP67/IP68					
Contact resistance/接触电阻	< 10mΩ					
Insulation resistance/绝缘电阻	≥ 100MΩ					
Pin contact/插针材料	CuZn					
Socket contact/插孔材料	CuSn					
Contact plating/针孔镀层材料	Au					

M8 Circular connectors

Female panel connector

Product figure (front fastened solder)



Scale diagram

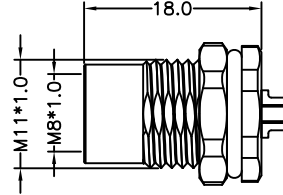

Contact layout/针孔排布 (Front view/前视图)

3pins

A



4pins

A



4pins

A



6pins

A



8pins

A

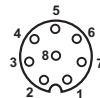

5pins

B

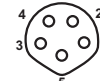

4pins

D

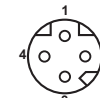

Order data/订货信息

Contacts/芯数	Coding	Order No/订货号	P/N/料号
3pins	A	080103-04-004	PMM08FAF03001
4pins	A	080104-04-004	PMM08FAF04001
	A(fool-proof)	080104-04-013	PMM08FAF04007
	D	080404-04-001	PMM08FDF04001
5pins	B	080205-04-004	PMM08FBF05001
6pins	A	080106-04-004	PMM08FAF06001
8pins	A	080108-04-004	PMM08FAF08001

Specifications/技术参数

Number of contacts/芯数	3	4 A-coding	4 D-coding	5	6	8
Termination/接线方式	solder/焊线式					
Wire gauge/线规	0.14/0.25/0.34 mm ² / (26/24/22 AWG)					
Operating temperature/工作温度	-25°C ~ +80°C					
Mechanical operation/插拔次数	> 100 mating cycles					
Rated voltage/额定电压	50V AC / 60V DC		60V	30V		
Rated current (40°C)/额定电流	3A		4A	3A	1.5A	
Protection degree/防护等级	IP67/IP68					
Contact resistance/接触电阻	< 10mΩ					
Insulation resistance/绝缘电阻	≥100MΩ					
Pin contact/插针材料	CuZn					
Socket contact/插孔材料	CuSn					
Contact plating/针孔镀层材料	Au					

M8 Circular connectors

Female panel connector

Product figure (M8*1.0 rear fastened solder)

Scale diagram

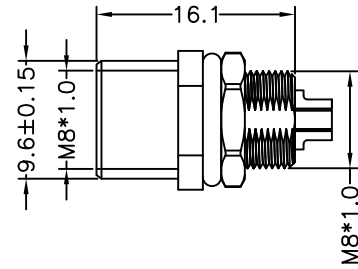

Contact layout/针孔排布 (Front view/前视图)

3pins

4pins

4pins

6pins

8pins

5pins

4pins

A

A

A

A

A

B

D

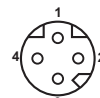
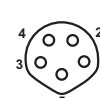
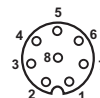

Order data/订货信息

Contacts/芯数	Coding	Order No/订货号	P/N/料号
3pins	A	080103-04-001	PMM08BAF03002
4pins	A	080104-04-001	PMM08BAF04002
	A(fool-proof)	080104-04-014	PMM08BAF04008
	D	080404-04-002	PMM08BDF04002
5pins	B	080205-04-001	PMM08BBF05002
6pins	A	080106-04-001	PMM08BAF06002
8pins	A	080108-04-001	PMM08BAF08002

Specifications/技术参数

Number of contacts/芯数	3	4 A-coding	4 D-coding	5	6	8
Termination/接线方式	solder/焊线式					
Wire gauge/线规	0.14/0.25/0.34 mm ² / (26/24/22 AWG)					
Operating temperature/工作温度	-25°C ~ +80°C					
Mechanical operation/插拔次数	> 100 mating cycles					
Rated voltage/额定电压	50V AC / 60V DC		60V	30V		
Rated current (40°C)/额定电流	3A		4A	3A	1.5A	
Protection degree/防护等级	IP67/IP68					
Contact resistance/接触电阻	< 10mΩ					
Insulation resistance/绝缘电阻	≥ 100MΩ					
Pin contact/插针材料	CuZn					
Socket contact/插孔材料	CuSn					
Contact plating/针孔镀层材料	Au					

M8 Circular connectors

Female panel connector

Product figure (M8*0.5 rear fastened solder)



Scale diagram

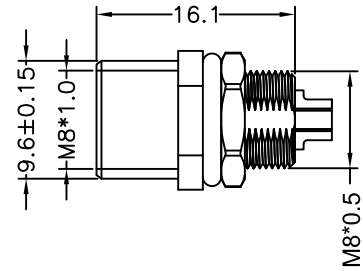

Contact layout/针孔排布 (Front view/前视图)

3pins

A



4pins

A



4pins

A



6pins

A



8pins

A



5pins

B



4pins

D



Order data/订货信息

Contacts/芯数	Coding	Order No/订货号	P/N/料号
3pins	A	080103-04-002	PMM08BAF03003
4pins	A	080104-04-002	PMM08BAF04003
	A(fool-proof)	080104-04-015	PMM08BAF04009
	D	080404-04-003	PMM08BDF04003
5pins	B	080205-04-002	PMM08BBF05003
6pins	A	080106-04-002	PMM08BAF06003
8pins	A	080108-04-002	PMM08BAF08003

Specifications/技术参数

Number of contacts/芯数	3	4 A-coding	4 D-coding	5	6	8
Termination/接线方式	solder/焊线式					
Wire gauge/线规	0.14/0.25/0.34 mm ² / (26/24/22 AWG)					
Operating temperature/工作温度	-25°C ~ +80°C					
Mechanical operation/插拔次数	> 100 mating cycles					
Rated voltage/额定电压	50V AC / 60V DC		60V	30V		
Rated current (40°C)/额定电流	3A		4A	3A	1.5A	
Protection degree/防护等级	IP67/IP68					
Contact resistance/接触电阻	< 10mΩ					
Insulation resistance/绝缘电阻	≥ 100MΩ					
Pin contact/插针材料	CuZn					
Socket contact/插孔材料	CuSn					
Contact plating/针孔镀层材料	Au					

M8 Circular connectors

Male panel connector

Product figure (rear fastened DIP)

Scale diagram

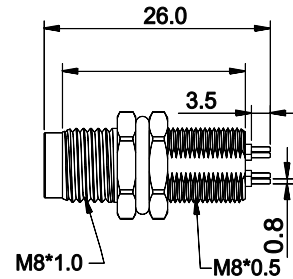

Contact layout/针孔排布 (Front view/前视图)

3pins

4pins

4pins

6pins

8pins

5pins

4pins

A

A

A

A

A

B

D

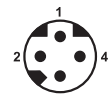

Order data/订货信息

Contacts/芯数	Coding	Order No/订货号	P/N/料号
3pins	A	080103-03-002	PMM08BAM03002
4pins	A	080104-03-002	PMM08BAM04002
	A(fool-proof)	080104-03-010	PMM08BAM04006
	D	080404-03-002	PMM08BDM04002
5pins	B	080205-03-002	PMM08BBM05002
6pins	A	080106-03-002	PMM08BAM06002
8pins	A	080108-03-002	PMM08BAM08002

Specifications/技术参数

Number of contacts/芯数	3	4 A-coding	4 D-coding	5	6	8
Termination/接线方式	PCB/插板式					
Wire gauge/线规	—					
Operating temperature/工作温度	-25°C~+85°C					
Mechanical operation/插拔次数	> 100 mating cycles					
Rated voltage/额定电压	50V AC / 60V DC		60V	30V		
Rated current (40°C)/额定电流	3A		4A	3A	1.5A	
Protection degree/防护等级	IP67/IP68					
Contact resistance/接触电阻	< 10mΩ					
Insulation resistance/绝缘电阻	≥100MΩ					
Pin contact/插针材料	CuZn					
Socket contact/插孔材料	CuSn					
Contact plating/针孔镀层材料	Au					

Female panel connector

Product figure (M8*1.0 rear fastened DIP)

Scale diagram

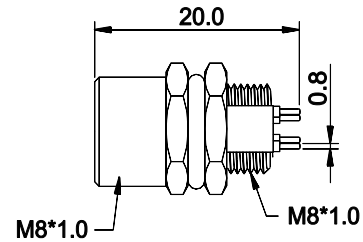

Contact layout/针孔排布 (Front view/前视图)

3pins

4pins

4pins

6pins

8pins

5pins

4pins

A

A

A

A

A

B

D



Order data/订货信息

Contacts/芯数	Coding	Order No/订货号	P/N/料号
3pins	A	080103-04-003	PMM08BAF03005
4pins	A	080104-04-003	PMM08BAF04005
	A(fool-proof)	080104-04-016	PMM08BAF04010
	D	080404-04-004	PMM08BDF04004
5pins	B	080205-04-003	PMM08BBF05005
6pins	A	080106-04-003	PMM08BAF06005
8pins	A	080108-04-003	PMM08BAF08005

Specifications/技术参数

Number of contacts/芯数	3	4 A-coding	4 D-coding	5	6	8
Termination/接线方式	PCB/插板式					
Wire gauge/线规	—					
Operating temperature/工作温度	-25°C ~ +85°C					
Mechanical operation/插拔次数	> 100 mating cycles					
Rated voltage/额定电压	50V AC / 60V DC		60V	30V		
Rated current (40°C)/额定电流	3A		4A	3A	1.5A	
Protection degree/防护等级	IP67/IP68					
Contact resistance/接触电阻	< 10mΩ					
Insulation resistance/绝缘电阻	≥ 100MΩ					
Pin contact/插针材料	CuZn					
Socket contact/插孔材料	CuSn					
Contact plating/针孔镀层材料	Au					

M8 Circular connectors

Female panel connector

Product figure (M8*0.5 rear fastened DIP)

Scale diagram

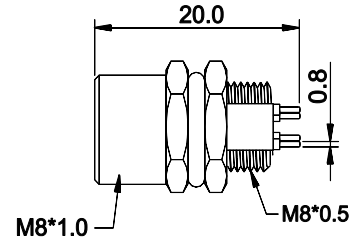

Contact layout/针孔排布 (Front view/前视图)

3pins

4pins

4pins

6pins

8pins

5pins

4pins

A

A

A

A

A

B

D

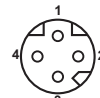
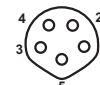
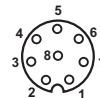

Order data/订货信息

Contacts/芯数	Coding	Order No/订货号	P/N/料号
3pins	A	080103-04-022	PMM08BAF03007
4pins	A	080104-04-037	PMM08BAF04013
	A(fool-proof)	080104-04-038	PMM08BAF04014
	D	080504-04-005	PMM08BDF04005
5pins	B	080205-04-018	PMM08BBF05007
6pins	A	080106-04-015	PMM08BAF06007
8pins	A	080108-04-018	PMM08BAF08007

Specifications/技术参数

Number of contacts/芯数	3	4 A-coding	4 D-coding	5	6	8
Termination/接线方式	PCB/插板式					
Wire gauge/线规	—					
Operating temperature/工作温度	-25°C~+85°C					
Mechanical operation/插拔次数	> 100 mating cycles					
Rated voltage/额定电压	50V AC / 60V DC		60V	30V		
Rated current (40°C)/额定电流	3A		4A	3A	1.5A	
Protection degree/防护等级	IP67/IP68					
Contact resistance/接触电阻	< 10mΩ					
Insulation resistance/绝缘电阻	≥100MΩ					
Pin contact/插针材料	CuZn					
Socket contact/插孔材料	CuSn					
Contact plating/针孔镀层材料	Au					

Male panel connector

Product figure (front fastened DIP)



Scale diagram

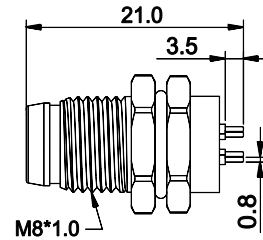

Contact layout/针孔排布 (Front view/前视图)

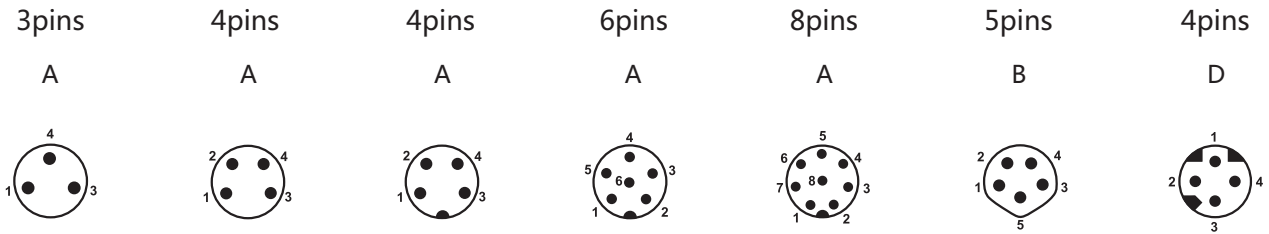

Order data/订货信息

Contacts/芯数	Coding	Order No/订货号	P/N/料号
3pins	A	080103-03-003	PMM08FAM03003
4pins	A	080104-03-003	PMM08FAM04003
	A(fool-proof)	080104-03-011	PMM08FAM04007
	D	080404-03-003	PMM08FDM04003
5pins	B	080205-03-003	PMM08FBM05003
6pins	A	080106-03-003	PMM08FAM06003
8pins	A	080108-03-003	PMM08FAM08003

Specifications/技术参数

Number of contacts/芯数	3	4 A-coding	4 D-coding	5	6	8
Termination/接线方式	PCB/插板式					
Wire gauge/线规	—					
Operating temperature/工作温度	-25°C~+85°C					
Mechanical operation/插拔次数	> 100 mating cycles					
Rated voltage/额定电压	50V AC / 60V DC		60V	30V		
Rated current (40°C)/额定电流	3A		4A	3A	1.5A	
Protection degree/防护等级	IP67/IP68					
Contact resistance/接触电阻	< 10mΩ					
Insulation resistance/绝缘电阻	≥100MΩ					
Pin contact/插针材料	CuZn					
Socket contact/插孔材料	CuSn					
Contact plating/针孔镀层材料	Au					

M8 Circular connectors

Female panel connector

Product figure (front fastened DIP)

Scale diagram

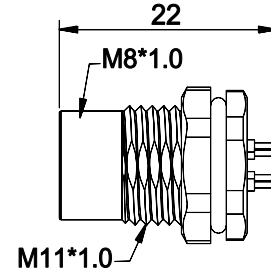

Contact layout/针孔排布 (Front view/前视图)

3pins

4pins

4pins

6pins

8pins

5pins

4pins

A

A

A

A

A

B

D

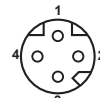
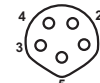
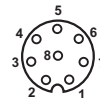

Order data/订货信息

Contacts/芯数	Coding	Order No/订货号	P/N/料号
3pins	A	080103-04-005	PMM08FAF03004
4pins	A	080104-04-005	PMM08FAF04004
	A(fool-proof)	080104-04-017	PMM08FAF04011
	D	080404-04-006	PMM08FDF04006
5pins	B	080205-04-005	PMM08FBF05004
6pins	A	080106-04-005	PMM08FAF06004
8pins	A	080108-04-005	PMM08FAF08004

Specifications/技术参数

Number of contacts/芯数	3	4 A-coding	4 D-coding	5	6	8
Termination/接线方式	PCB/插板式					
Wire gauge/线规	—					
Operating temperature/工作温度	-25°C ~ +85°C					
Mechanical operation/插拔次数	> 100 mating cycles					
Rated voltage/额定电压	50V AC / 60V DC		60V	30V		
Rated current (40°C)/额定电流	3A		4A	3A	1.5A	
Protection degree/防护等级	IP67/IP68					
Contact resistance/接触电阻	< 10mΩ					
Insulation resistance/绝缘电阻	≥ 100MΩ					
Pin contact/插针材料	CuZn					
Socket contact/插孔材料	CuSn					
Contact plating/针孔镀层材料	Au					

Male panel connector (90°)

Product figure



Scale diagram

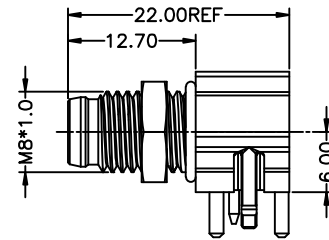

Contact layout/针孔排布 (Front view/前视图)

3pins

4pins

5pins

A

A

B

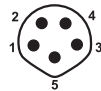

Order data/订货信息

Contacts/芯数	Coding	Order No/订货号	P/N/料号
3pins	A	080103-03-004	PMM08FAM03004
4pins	A	080104-03-004	PMM08FAM04004
5pins	B	080205-03-006	PMM08FBM05004

Specifications/技术参数

Number of contacts/芯数	3	4	5
Termination/接线方式	PCB/插板式		
Wire gauge/线规	—		
Operating temperature/工作温度	-25°C ~ +85°C		
Mechanical operation/插拔次数	> 100 mating cycles		
Rated voltage/额定电压	50V AC / 60V DC		30V
Rated current (40°C)/额定电流	3A		
Protection degree/防护等级	IP67/IP68		
Contact resistance/接触电阻	< 10mΩ		
Insulation resistance/绝缘电阻	≥ 100MΩ		
Pin contact/插针材料	CuZn		
Socket contact/插孔材料	CuSn		
Contact plating/针孔镀层材料	Au		

M8 Circular connectors

Female panel connector (90°)

Product figure



Scale diagram

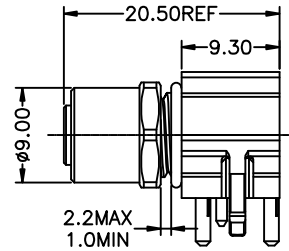

Contact layout/针孔排布 (Front view/前视图)

3pins

4pins

5pins

A

A

B

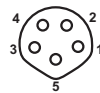

Order data/订货信息

Contacts/芯数	Coding	Order No/订货号	P/N/料号
3pins	A	080103-04-007	PMM08FAF03006
4pins	A	080104-04-006	PMM08FAF04006
5pins	A	080205-04-008	PMM08FBF05006

Specifications/技术参数

Number of contacts/芯数	3	4	5
Termination/接线方式	PCB/插板式		
Wire gauge/线规	—		
Operating temperature/工作温度	-25°C ~ +85°C		
Mechanical operation/插拔次数	> 100 mating cycles		
Rated voltage/额定电压	50V AC / 60V DC		30V
Rated current (40°C)/额定电流	3A		
Protection degree/防护等级	IP67/IP68		
Contact resistance/接触电阻	< 10mΩ		
Insulation resistance/绝缘电阻	≥ 100MΩ		
Pin contact/插针材料	CuZn		
Socket contact/插孔材料	CuSn		
Contact plating/针孔镀层材料	Au		

M8 Circular connectors

Male panel connector (90°)

Product figure

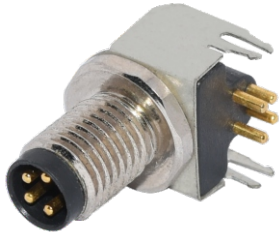

Scale diagram

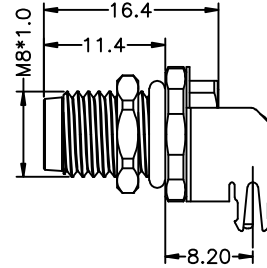

Contact layout/针孔排布 (Front view/前视图)

3pins

A



4pins

A



5pins

B



6pins

A



8pins

A



Order data/订货信息

Contacts/芯数	Coding	Order No/订货号	P/N/料号
3pins	A	080103-03-013	—
4pins	A	080104-03-029	—
5pins	B	080205-03-021	—
6pins	A	080106-03-021	—
8pins	A	080108-03-019	—

Specifications/技术参数

Number of contacts/芯数	3	4	5	6	8
Termination/接线方式	PCB/插板式				
Wire gauge/线规	—				
Operating temperature/工作温度	-25°C ~ +80°C				
Mechanical operation/插拔次数	> 100 mating cycles				
Rated voltage/额定电压	50V AC / 60V DC			30V	
Rated current (40°C)/额定电流	3A			1.5A	
Protection degree/防护等级	IP67/IP68				
Contact resistance/接触电阻	< 10mΩ				
Insulation resistance/绝缘电阻	≥ 100MΩ				
Pin contact/插针材料	CuZn				
Socket contact/插孔材料	CuSn				
Contact plating/针孔镀层材料	Au				

M8 Circular connectors

Female panel connector (90°)

Product figure

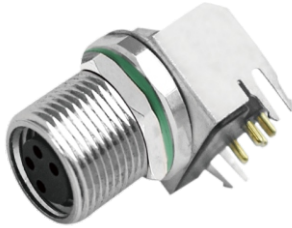

Scale diagram

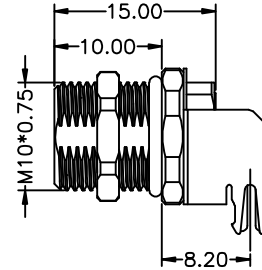

Contact layout/针孔排布 (Front view/前视图)

3pins

4pins

5pins

6pins

8pins

A

A

B

A

A



Order data/订货信息

Contacts/芯数	Coding	Order No/订货号	P/N/料号
3pins	A	080103-04-020	—
4pins	A	080104-04-033	—
5pins	B	080205-04-026	—
6pins	A	080106-04-024	—
8pins	A	080108-04-040	—

Specifications/技术参数

Number of contacts/芯数	3	4	5	6	8
Termination/接线方式	PCB/插板式				
Wire gauge/线规	—				
Operating temperature/工作温度	-25°C ~ +80°C				
Mechanical operation/插拔次数	> 100 mating cycles				
Rated voltage/额定电压	50V AC / 60V DC			30V	
Rated current (40°C)/额定电流	3A			1.5A	
Protection degree/防护等级	IP67/IP68				
Contact resistance/接触电阻	< 10mΩ				
Insulation resistance/绝缘电阻	≥ 100MΩ				
Pin contact/插针材料	CuZn				
Socket contact/插孔材料	CuSn				
Contact plating/针孔镀层材料	Au				

SMT connector

Product figure



Scale diagram

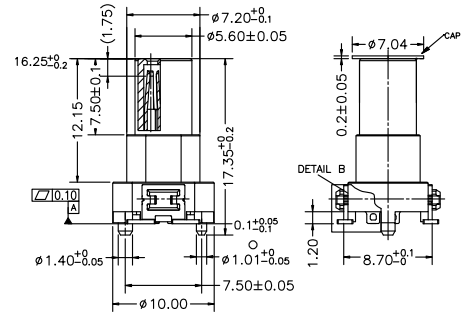

Contact layout/针孔排布 (Front view/前视图)

4pins

8pins

A

A

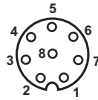

Order data/订货信息

Contacts/芯数	Coding	Order No/订货号	P/N/料号
4pins	A	080103-04-033	—
8pins	A	080108-04-033	—

Specifications/技术参数

Number of contacts/芯数	4	8
Termination/接线方式	SMT/插板式	
Wire gauge/线规	—	
Operating temperature/工作温度	-25°C ~ +85°C	
Mechanical operation/插拔次数	> 100 mating cycles	
Rated voltage/额定电压	50V AC / 60V DC	30V
Rated current (40°C)/额定电流	3A	1.5A
Protection degree/防护等级	IP67	
Contact resistance/接触电阻	< 10mΩ	
Insulation resistance/绝缘电阻	≥100MΩ	
Pin contact/插针材料	CuZn	
Socket contact/插孔材料	CuSn	
Contact plating/针孔镀层材料	Au	

M8 Circular connectors

Male cable

Product figure



Scale diagram

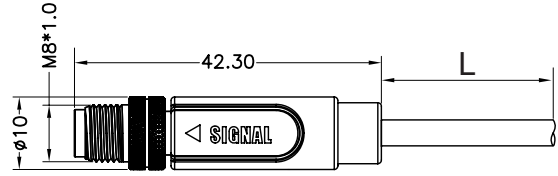

Contact layout/针孔排布 (Front view/前视图)

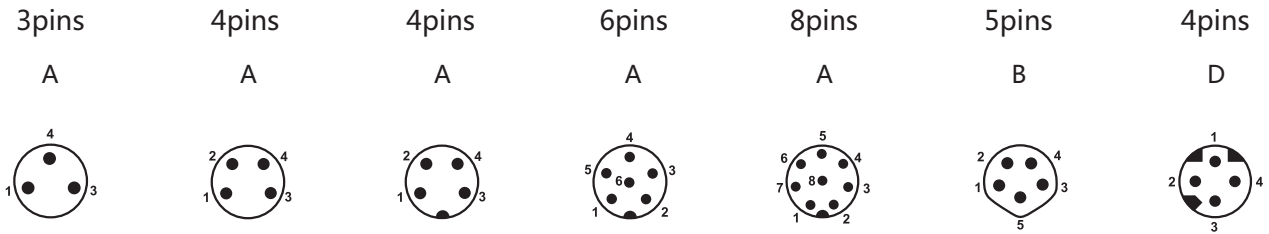

Order data/订货信息

Contacts/芯数	Coding	Order No/订货号	P/N/料号
3pins	A	080103-05-002	CAM08SAM03001
4pins	A	080104-05-002	CAM08SAM04001
	A(fool-proof)	080104-05-008	CAM08SAM04005
	D	080404-05-001	CAM08SDM04001
5pins	B	080205-05-002	CAM08SBM05001
6pins	A	080106-05-002	CAM08SAM06001
8pins	A	080108-05-002	CAM08SAM08001

Specifications/技术参数

Number of contacts/芯数	3	4 A-coding	4 D-coding	5	6	8
Termination/接线方式	moulded on cable/成型线					
Wire gauge/线规	0.14/0.25/0.34 mm ² / (26/24/22 AWG)					
Operating temperature/工作温度	-25°C ~ +80°C					
Mechanical operation/插拔次数	> 100 mating cycles					
Rated voltage/额定电压	50V AC / 60V DC		60V	30V		
Rated current (40°C)/额定电流	3A		4A	3A	1.5A	
Protection degree/防护等级	IP67/IP68					
Contact resistance/接触电阻	< 10mΩ					
Insulation resistance/绝缘电阻	≥ 100MΩ					
Pin contact/插针材料	CuZn					
Socket contact/插孔材料	CuSn					
Contact plating/针孔镀层材料	Au					

M8 Circular connectors

Female cable

Product figure



Scale diagram

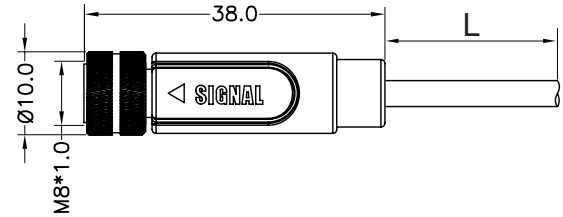

Contact layout/针孔排布 (Front view/前视图)

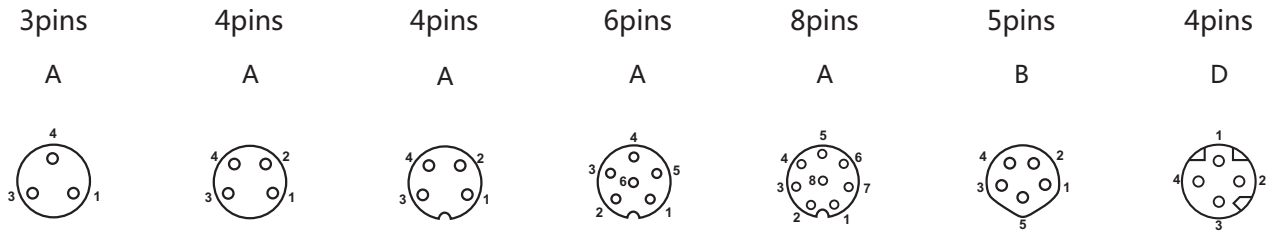

Order data/订货信息

Contacts/芯数	Coding	Order No/订货号	P/N/料号
3pins	A	080103-06-003	CAM08SAF03001
4pins	A	080104-06-003	CAM08SAF04001
	A(fool-proof)	080104-06-015	CAM08SAF04004
	D	080404-06-001	CAM08SDF04001
5pins	B	080205-06-002	CAM08SBF05001
6pins	A	080106-06-002	CAM08SAF06001
8pins	A	080108-06-002	CAM08SAF08001

Specifications/技术参数

Number of contacts/芯数	3	4 A-coding	4 D-coding	5	6	8
Termination/接线方式	moulded on cable/成型线					
Wire gauge/线规	0.14/0.25/0.34 mm ² / (26/24/22 AWG)					
Operating temperature/工作温度	-25°C ~ +80°C					
Mechanical operation/插拔次数	> 100 mating cycles					
Rated voltage/额定电压	50V AC / 60V DC		60V	30V		
Rated current (40°C)/额定电流	3A		4A	3A	1.5A	
Protection degree/防护等级	IP67/IP68					
Contact resistance/接触电阻	< 10mΩ					
Insulation resistance/绝缘电阻	≥100MΩ					
Pin contact/插针材料	CuZn					
Socket contact/插孔材料	CuSn					
Contact plating/针孔镀层材料	Au					

M8 Circular connectors

Male cable (90°)

Product figure



Scale diagram

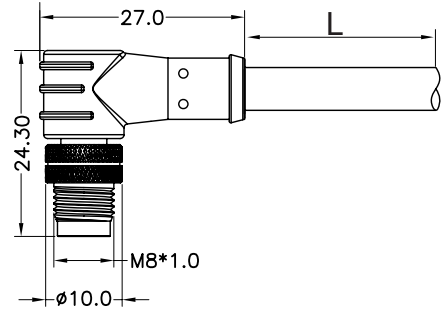

Contact layout/针孔排布 (Front view/前视图)

3pins

A



4pins

A



4pins

A



6pins

A



8pins

A



5pins

B



4pins

D



Order data/订货信息

Contacts/芯数	Coding	Order No/订货号	P/N/料号
3pins	A	080103-05-001	CAM08RAM03002
4pins	A	080104-05-001	CAM08RAM04002
	A(fool-proof)	080104-05-009	CAM08RAM04006
	D	080404-05-002	CAM08RDM04002
5pins	B	080205-05-001	CAM08RBM05002
6pins	A	080106-05-001	CAM08RAM06002
8pins	A	080108-05-001	CAM08RAM08002

Specifications/技术参数

Number of contacts/芯数	3	4 A-coding	4 D-coding	5	6	8
Termination/接线方式	moulded on cable/成型线					
Wire gauge/线规	0.14/0.25/0.34 mm ² / (26/24/22 AWG)					
Operating temperature/工作温度	-25°C ~ +80°C					
Mechanical operation/插拔次数	> 100 mating cycles					
Rated voltage/额定电压	50V AC / 60V DC		60V	30V		
Rated current (40°C)/额定电流	3A		4A	3A	1.5A	
Protection degree/防护等级	IP67/IP68					
Contact resistance/接触电阻	< 10mΩ					
Insulation resistance/绝缘电阻	≥100MΩ					
Pin contact/插针材料	CuZn					
Socket contact/插孔材料	CuSn					
Contact plating/针孔镀层材料	Au					

Female cable (90°)

Product figure



Scale diagram

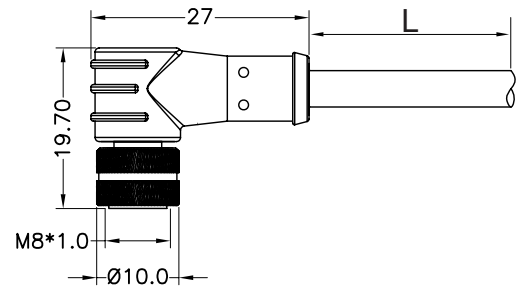

Contact layout/针孔排布 (Front view/前视图)

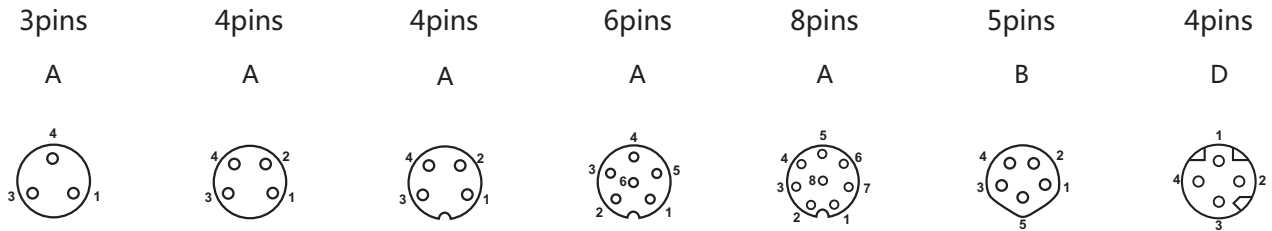

Order data/订货信息

Contacts/芯数	Coding	Order No/订货号	P/N/料号
3pins	A	080103-06-001	CAM08RAF03002
4pins	A	080104-06-001	CAM08RAF04002
	A(fool-proof)	080104-06-016	CAM08RAF04005
	D	080404-06-002	CAM08RDF04002
5pins	B	080205-06-001	CAM08RBF05002
6pins	A	080106-06-001	CAM08RAF06002
8pins	A	080108-06-001	CAM08RAF08002

Specifications/技术参数

Number of contacts/芯数	3	4 A-coding	4 D-coding	5	6	8
Termination/接线方式	moulded on cable/成型线					
Wire gauge/线规	0.14/0.25/0.34 mm ² / (26/24/22 AWG)					
Operating temperature/工作温度	-25°C ~ +80°C					
Mechanical operation/插拔次数	> 100 mating cycles					
Rated voltage/额定电压	50V AC / 60V DC		60V	30V		
Rated current (40°C)/额定电流	3A		4A	3A	1.5A	
Protection degree/防护等级	IP67/IP68					
Contact resistance/接触电阻	< 10mΩ					
Insulation resistance/绝缘电阻	≥100MΩ					
Pin contact/插针材料	CuZn					
Socket contact/插孔材料	CuSn					
Contact plating/针孔镀层材料	Au					

M8 Circular connectors

Male cable

Product figure



Scale diagram

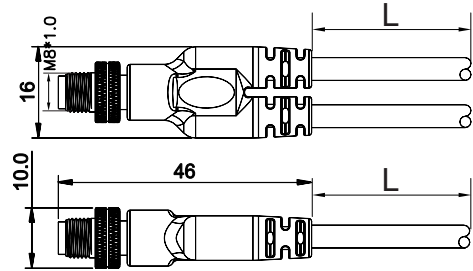

Contact layout/针孔排布 (Front view/前视图)

3pins

4pins

4pins

5pins

A

A

A

B



Order data/订货信息

Contacts/芯数	Coding	Order No/订货号	P/N/料号
3pins	A	080103-30-001	CAM08SAM03003
4pins	A	080104-30-001	CAM08SAM04003
	A(fool-proof)	080104-30-003	CAM08SAM04007
5pins	B	080205-30-001	CAM08SBM05003

Specifications/技术参数

Number of contacts/芯数	3	4	5
Termination/接线方式	moulded on cable/成型线		
Wire gauge/线规	0.14/0.25/0.34 mm ² / (26/24/22 AWG)		
Operating temperature/工作温度	-25°C ~ +80°C		
Mechanical operation/插拔次数	> 100 mating cycles		
Rated voltage/额定电压	50V AC / 60V DC		30V
Rated current (40°C)/额定电流	3A		
Protection degree/防护等级	IP67/IP68		
Contact resistance/接触电阻	< 10mΩ		
Insulation resistance/绝缘电阻	≥100MΩ		
Pin contact/插针材料	CuZn		
Socket contact/插孔材料	CuSn		
Contact plating/针孔镀层材料	Au		

Female cable (with LED PNP)

Product figure



Scale diagram

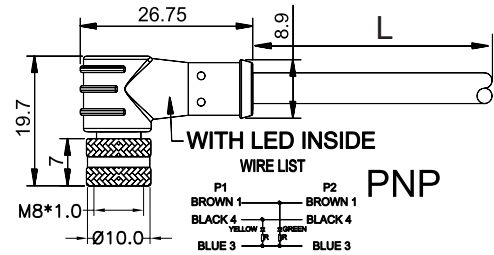

Contact layout/针孔排布 (Front view/前视图)

3pins

4pins

4pins

A

A

A



Order data/订货信息

Contacts/芯数	Coding	Order No/订货号	P/N/料号
3pins	A	080103-06-002	CAM08RAF03003
4pins	A	080104-06-002	CAM08RAF04003
	A(fool-proof)	080104-06-017	CAM08RAF04006

Specifications/技术参数

Number of contacts/芯数	3	4
Termination/接线方式	moulded on cable/成型线	
Wire gauge/线规	0.14/0.25/0.34 mm ² / (26/24/22 AWG)	
Operating temperature/工作温度	-25°C ~ +80°C	
Mechanical operation/插拔次数	> 100 mating cycles	
Rated voltage/额定电压	50V AC / 60V DC	
Rated current (40°C)/额定电流	3A	
Protection degree/防护等级	IP67/IP68	
Contact resistance/接触电阻	< 10mΩ	
Insulation resistance/绝缘电阻	≥100MΩ	
Pin contact/插针材料	CuZn	
Socket contact/插孔材料	CuSn	
Contact plating/针孔镀层材料	Au	

M8 Circular connectors

Male cable (with LED PNP)

Product figure



Scale diagram

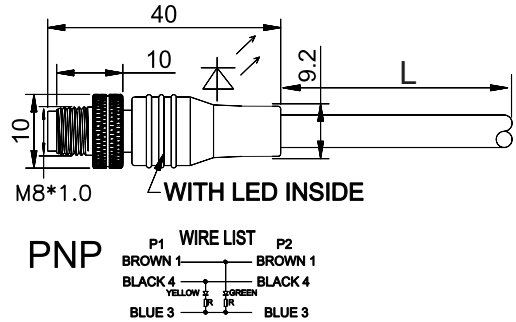

Contact layout/针孔排布 (Front view/前视图)

3pins

4pins

4pins

A

A

A



Order data/订货信息

Contacts/芯数	Coding	Order No/订货号	P/N/料号
3pins	A	080103-05-003	CAM08SAM03004
4pins	A	080104-05-003	CAM08SAM04004
	A(fool-proof)	080104-05-010	CAM08SAM04007

Specifications/技术参数

Number of contacts/芯数	3	4
Termination/接线方式	moulded on cable/成型线	
Wire gauge/线规	0.14/0.25/0.34 mm ² / (26/24/22 AWG)	
Operating temperature/工作温度	-25°C ~ +80°C	
Mechanical operation/插拔次数	> 100 mating cycles	
Rated voltage/额定电压	50V AC / 60V DC	
Rated current (40°C)/额定电流	3A	
Protection degree/防护等级	IP67/IP68	
Contact resistance/接触电阻	< 10mΩ	
Insulation resistance/绝缘电阻	≥100MΩ	
Pin contact/插针材料	CuZn	
Socket contact/插孔材料	CuSn	
Contact plating/针孔镀层材料	Au	

M8 Circular connectors

T-Splitter

Product figure (Male to Dual Male)



Scale diagram

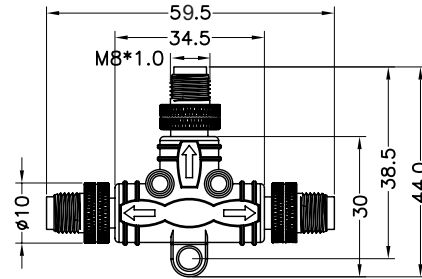

Contact layout/针孔排布 (Front view/前视图)

3pins

4pins

4pins

5pins

A

A

A

B



Order data/订货信息

Contacts/芯数	Coding	Order No/订货号	P/N/料号
3pins	A	080103-10-001	SPM08TA03001
4pins	A	080104-10-001	SPM08TA04001
	A(fool-proof)	080104-10-007	SPM08TA04006
5pins	B	080205-10-001	SPM08TB05001

Specifications/技术参数

Number of contacts/芯数	3	4	5
Termination/接线方式		—	
Wire gauge/线规		—	
Operating temperature/工作温度	-25°C~+80°C		
Mechanical operation/插拔次数	> 100 mating cycles		
Rated voltage/额定电压	50V AC / 60V DC		30V
Rated current (40°C)/额定电流	3A		
Protection degree/防护等级	IP67/IP68		
Contact resistance/接触电阻	< 10mΩ		
Insulation resistance/绝缘电阻	≥100MΩ		
Pin contact/插针材料	CuZn		
Socket contact/插孔材料	CuSn		
Contact plating/针孔镀层材料	Au		

M8 Circular connectors

T-Splitter

Product figure (Female to Dual Female)

Scale diagram

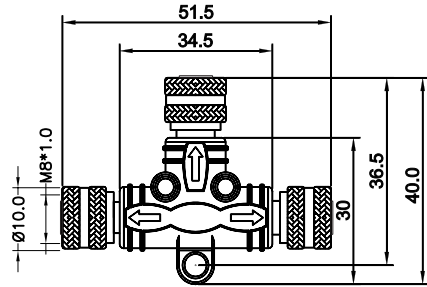

Contact layout/针孔排布 (Front view/前视图)

3pins

4pins

4pins

5pins

A

A

A

B



Order data/订货信息

Contacts/芯数	Coding	Order No/订货号	P/N/料号
3pins	A	080103-10-002	SPM08TA03002
4pins	A	080104-10-002	SPM08TA04002
	A(fool-proof)	080104-10-008	SPM08TA04007
5pins	B	080205-10-002	SPM08TB05002

Specifications/技术参数

Number of contacts/芯数	3	4	5
Termination/接线方式		—	
Wire gauge/线规		—	
Operating temperature/工作温度	-25°C ~ +80°C		
Mechanical operation/插拔次数	> 100 mating cycles		
Rated voltage/额定电压	50V AC / 60V DC		30V
Rated current (40°C)/额定电流	3A		
Protection degree/防护等级	IP67/IP68		
Contact resistance/接触电阻	< 10mΩ		
Insulation resistance/绝缘电阻	≥ 100MΩ		
Pin contact/插针材料	CuZn		
Socket contact/插孔材料	CuSn		
Contact plating/针孔镀层材料	Au		

M8 Circular connectors

T-Splitter

Product figure (Male to Dual Female)



Scale diagram

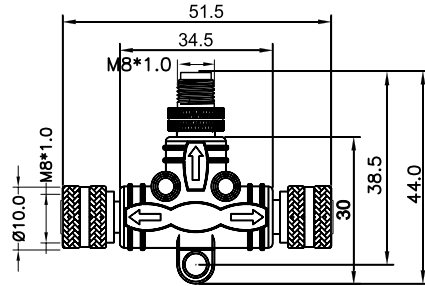

Contact layout/针孔排布 (Front view/前视图)

3pins

A



4pins

A

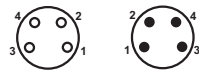

4pins

A

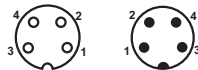

5pins

B

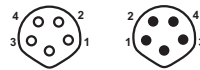

Order data/订货信息

Contacts/芯数	Coding	Order No/订货号	P/N/料号
3pins	A	080103-10-003	SPM08TA03003
4pins	A	080104-10-004	SPM08TA04003
	A(fool-proof)	080104-10-009	SPM08TA04008
5pins	B	080205-10-003	SPM08TB05003

Specifications/技术参数

Number of contacts/芯数	3	4	5
Termination/接线方式		—	
Wire gauge/线规		—	
Operating temperature/工作温度	-25°C ~ +80°C		
Mechanical operation/插拔次数	> 100 mating cycles		
Rated voltage/额定电压	50V AC / 60V DC		30V
Rated current (40°C)/额定电流	3A		
Protection degree/防护等级	IP67/IP68		
Contact resistance/接触电阻	< 10mΩ		
Insulation resistance/绝缘电阻	≥100MΩ		
Pin contact/插针材料	CuZn		
Socket contact/插孔材料	CuSn		
Contact plating/针孔镀层材料	Au		

M8 Circular connectors

T-Splitter

Product figure (Female to Male & Female)



Scale diagram

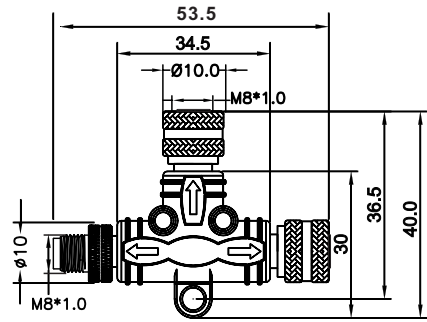

Contact layout/针孔排布 (Front view/前视图)

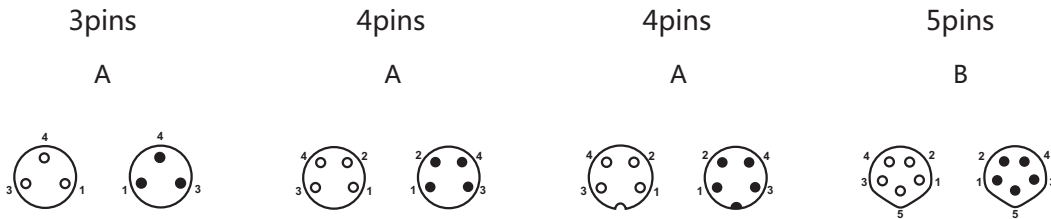

Order data/订货信息

Contacts/芯数	Coding	Order No/订货号	P/N/料号
3pins	A	080103-10-006	SPM08TA03006
4pins	A	080104-10-013	SPM08TA04011
	A(fool-proof)	080104-10-014	SPM08TA04012
5pins	B	080205-10-006	SPM08TB05006

Specifications/技术参数

Number of contacts/芯数	3	4	5
Termination/接线方式		—	
Wire gauge/线规		—	
Operating temperature/工作温度	-25°C ~ +80°C		
Mechanical operation/插拔次数	> 100 mating cycles		
Rated voltage/额定电压	50V AC / 60V DC		30V
Rated current (40°C)/额定电流	3A		
Protection degree/防护等级	IP67/IP68		
Contact resistance/接触电阻	< 10mΩ		
Insulation resistance/绝缘电阻	≥ 100MΩ		
Pin contact/插针材料	CuZn		
Socket contact/插孔材料	CuSn		
Contact plating/针孔镀层材料	Au		

T-Splitter

Product figure (Female to Dual Male)



Scale diagram

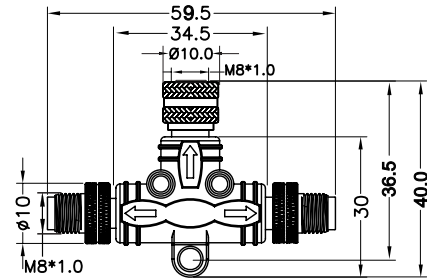

Contact layout/针孔排布 (Front view/前视图)

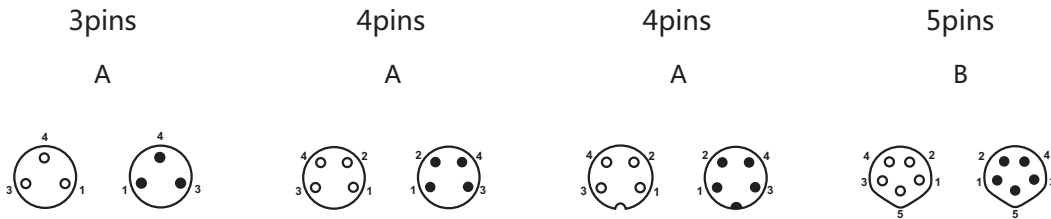

Order data/订货信息

Contacts/芯数	Coding	Order No/订货号	P/N/料号
3pins	A	080103-10-004	SPM08TA03004
4pins	A	080104-10-005	SPM08TA04004
	A(fool-proof)	080104-10-010	SPM08TA04009
5pins	B	080205-10-004	SPM08TB05004

Specifications/技术参数

Number of contacts/芯数	3	4	5
Termination/接线方式		—	
Wire gauge/线规		—	
Operating temperature/工作温度	-25°C ~ +80°C		
Mechanical operation/插拔次数	> 100 mating cycles		
Rated voltage/额定电压	50V AC / 60V DC		30V
Rated current (40°C)/额定电流	3A		
Protection degree/防护等级	IP67/IP68		
Contact resistance/接触电阻	< 10mΩ		
Insulation resistance/绝缘电阻	≥ 100MΩ		
Pin contact/插针材料	CuZn		
Socket contact/插孔材料	CuSn		
Contact plating/针孔镀层材料	Au		

M8 Circular connectors

Y-Splitter

Product figure (Male to Dual Female)



Scale diagram

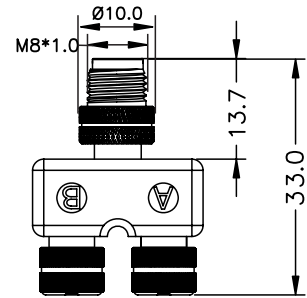

Contact layout/针孔排布 (Front view/前视图)

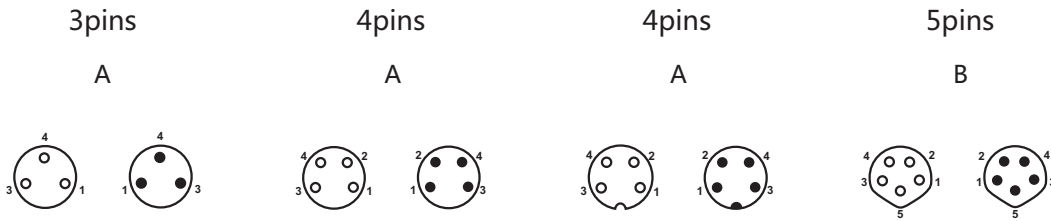

Order data/订货信息

Contacts/芯数	Coding	Order No/订货号	P/N/料号
3pins	A	080103-10-005	SPM08TA03005
4pins	A	080104-10-006	SPM08TA04005
	A(fool-proof)	080104-10-011	SPM08TA04010
5pins	B	080205-10-005	SPM08TB05005

Specifications/技术参数

Number of contacts/芯数	3	4	5
Termination/接线方式		—	
Wire gauge/线规		—	
Operating temperature/工作温度	-25°C~+80°C		
Mechanical operation/插拔次数	> 100 mating cycles		
Rated voltage/额定电压	50V AC / 60V DC		30V
Rated current (40°C)/额定电流	3A		
Protection degree/防护等级	IP67/IP68		
Contact resistance/接触电阻	< 10mΩ		
Insulation resistance/绝缘电阻	≥100MΩ		
Pin contact/插针材料	CuZn		
Socket contact/插孔材料	CuSn		
Contact plating/针孔镀层材料	Au		

I-Splitter

Product figure (Male to Female)



Scale diagram

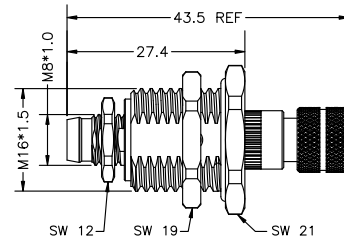

Contact layout/针孔排布 (Front view/前视图)

3pins

A



Order data/订货信息

Contacts/芯数	Coding	Order No/订货号	P/N/料号
3pins	A	080103-10-008	—

Specifications/技术参数

Number of contacts/芯数	3
Termination/接线方式	—
Wire gauge/线规	—
Operating temperature/工作温度	-25°C ~ +80°C
Mechanical operation/插拔次数	> 100 mating cycles
Rated voltage/额定电压	50V AC / 60V DC
Rated current (40°C)/额定电流	3A
Protection degree/防护等级	IP67/IP68
Contact resistance/接触电阻	< 10mΩ
Insulation resistance/绝缘电阻	≥100MΩ
Pin contact/插针材料	CuZn
Socket contact/插孔材料	CuSn
Contact plating/针孔镀层材料	Au

M8 Circular connectors

- M5
- M8**
- M9
- M12
- M16
- M17
- M23
- 7/8
- RD
- D-B
- NMEA
- D-Sub
- USB
- RF
- P-P

Protection cap for female connector

Product figure



Scale diagram

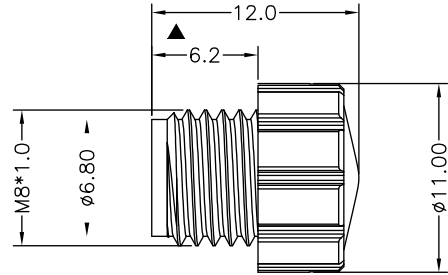

Order Data/订货信息

Order No/订货号	P/N/料号
080000-02-002	CN00680

Protection cap for Male connector

Product figure



Scale diagram

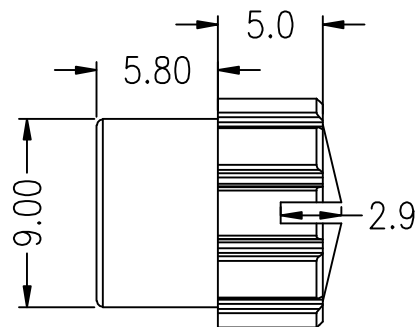

Order Data/订货信息

Order No/订货号	P/N/料号
080000-01-002	CN00672

M8 Automation Technology-Special-P-Coding

- M8 P-coding
- 4 contacts
- 24AWG/0.25mm² wire gauge
- -40°C-85°C temperature range
- 3A rated current
- 50V AC / 60V DC rated voltage
- IP67 degree of protection
- Cable assembly/Panel mount type
Field attachable type are available



M8 自动化技术特殊连接器 P型



- M8 P型
- 4 芯
- 22AWG/0.34mm² 线规
- -40°C-85°C 温度范围内
- 3A 额定电流
- 50V AC / 60V DC 额定电压
- IP67 防护等级
- 电缆组件/面板式/字段可连接类型

Grid area for notes.

Female panel connector

Product figure (front fastened)



Scale diagram

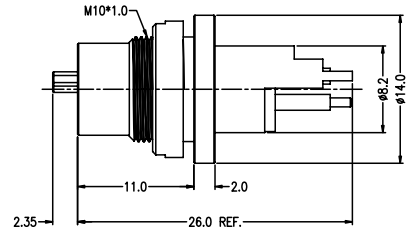

Contact layout/针孔排布 (Front view/前视图)

4pins

P



Order data/订货信息

Contacts/芯数	Coding	Order No/订货号	P/N/料号
4pins	P	080904-04-005	PMM08FPF04005

Specifications/技术参数

Number of contacts/芯数	4
Termination/接线方式	PCB/插板式
Wire gauge/线规	—
Operating temperature/工作温度	-25°C ~ +85°C
Mechanical operation/插拔次数	> 100 mating cycles
Rated voltage/额定电压	50V AC / 60V DC
Rated current (40°C)/额定电流	3A
Protection degree/防护等级	IP67/IP68
Contact resistance/接触电阻	< 10mΩ
Insulation resistance/绝缘电阻	≥ 100MΩ
Pin contact/插针材料	CuZn
Socket contact/插孔材料	CuSn
Contact plating/针孔镀层材料	Au

M8 Circular connectors

Male cable

Product figure



Scale diagram

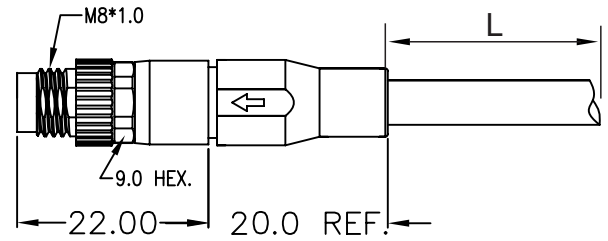

Contact layout/针孔排布 (Front view/前视图)

4pins

P



Order data/订货信息

Contacts/芯数	Coding	Order No/订货号	P/N/料号
4pins	P	080904-05-001	CAM08SPM04001

Specifications/技术参数

Number of contacts/芯数	4
Termination/接线方式	moulded on cable/成型线
Wire gauge/线规	0.25 mm ² / 24 AWG
Operating temperature/工作温度	-25°C ~ +80°C
Mechanical operation/插拔次数	> 100 mating cycles
Rated voltage/额定电压	50V AC / 60V DC
Rated current (40°C)/额定电流	3A
Protection degree/防护等级	IP67/IP68
Contact resistance/接触电阻	< 10mΩ
Insulation resistance/绝缘电阻	≥100MΩ
Pin contact/插针材料	CuZn
Socket contact/插孔材料	CuSn
Contact plating/针孔镀层材料	Au

Male panel connector

Product figure(front fastened)



Scale diagram

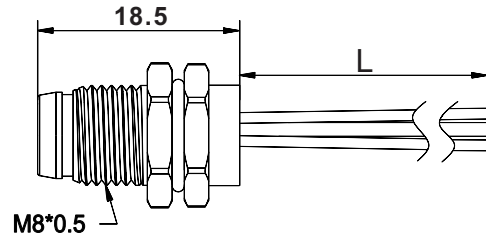

Contact layout/针孔排布(Front view/前视图)

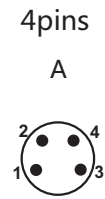

Circuit diagram/电路图

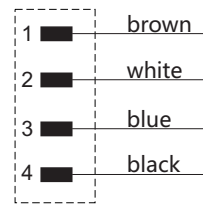
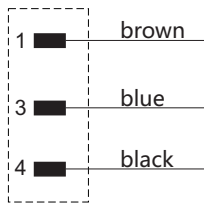

Order No/订货号

Cable length 线材长度	Contacts 芯数	Wire diameter 线径	PVC	TPE
0.1M	3pins	0.25mm ²	080103-03-911	080103-03-921
	4pins	0.25mm ²	080104-03-911	080104-03-921
0.2M	3pins	0.25mm ²	080103-03-912	080103-03-922
	4pins	0.25mm ²	080104-03-912	080104-03-922
0.5M	3pins	0.25mm ²	080103-03-913	080103-03-923
	4pins	0.25mm ²	080104-03-913	080104-03-923
1.0M	3pins	0.25mm ²	080103-03-914	080103-03-924
	4pins	0.25mm ²	080104-03-914	080104-03-924

Specification/技术参数

Number of contacts/芯数	3	4
Rated voltage/额定电压	50V AC / 60V DC	
Rated current (40°C)/额定电流	3A	
Protection degree/防护等级	IP67/IP68	
Operating temperature/工作温度	-25°C ~ +80°C	

M8 Circular connectors

Female panel connector

Product figure(front fastened)



Scale diagram

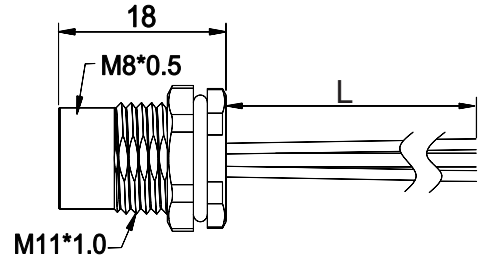

Contact layout/针孔排布(Front view/前视图)

3pins

A

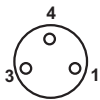

4pins

A

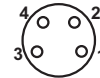

Circuit diagram/电路图

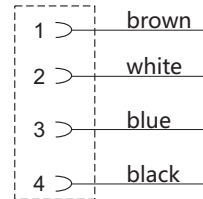
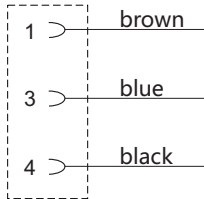

Order No/订货号

Cable length 线材长度	Contacts 芯数	Wire diameter 线径	PVC	TPE
0.1M	3pins	0.25mm ²	080103-04-911	080103-04-921
	4pins	0.25mm ²	080104-04-911	080104-04-921
0.2M	3pins	0.25mm ²	080103-04-912	080103-04-922
	4pins	0.25mm ²	080104-04-912	080104-04-922
0.5M	3pins	0.25mm ²	080103-04-913	080103-04-923
	4pins	0.25mm ²	080104-04-913	080104-04-923
1.0M	3pins	0.25mm ²	080103-04-914	080103-04-924
	4pins	0.25mm ²	080104-04-914	080104-04-924

Specification/技术参数

Number of contacts/芯数	3	4
Rated voltage/额定电压	50V AC / 60V DC	
Rated current (40°C)/额定电流	3A	
Protection degree/防护等级	IP67/IP68	
Operating temperature/工作温度	-25°C ~ +80°C	

Male panel connector

Product figure(rear fastened)



Scale diagram

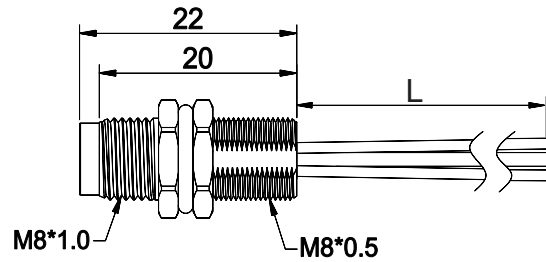

Contact layout/针孔排布(Front view/前视图)

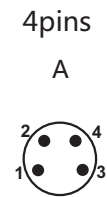
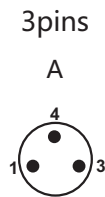

Circuit diagram/电路图

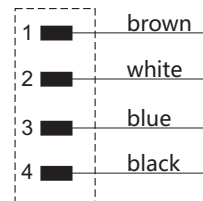
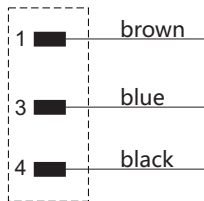

Order No/订货号

Cable length 线材长度	Contacts 芯数	Wire diameter 线径	PVC	TPE
0.1M	3pins	0.25mm ²	080103-03-811	080103-03-821
	4pins	0.25mm ²	080104-03-811	080104-03-821
0.2M	3pins	0.25mm ²	080103-03-812	080103-03-822
	4pins	0.25mm ²	080104-03-812	080104-03-822
0.5M	3pins	0.25mm ²	080103-03-813	080103-03-823
	4pins	0.25mm ²	080104-03-813	080104-03-823
1.0M	3pins	0.25mm ²	080103-03-814	080103-03-824
	4pins	0.25mm ²	080104-03-814	080104-03-824

Specification/技术参数

Number of contacts/芯数	3	4
Rated voltage/额定电压	50V AC / 60V DC	
Rated current (40°C)/额定电流	3A	
Protection degree/防护等级	IP67/IP68	
Operating temperature/工作温度	-25°C ~ +80°C	

M8 Circular connectors

Female panel connector

Product figure(rear fastened)



Scale diagram

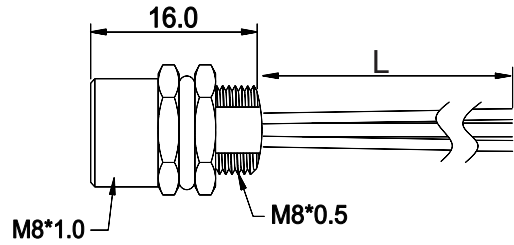

Contact layout/针孔排布(Front view/前视图)

3pins

A

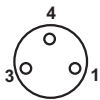

4pins

A

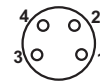

Circuit diagram/电路图

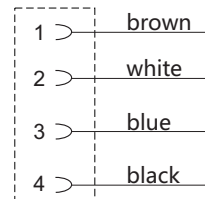
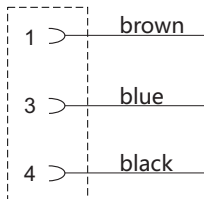

Order No/订货号

Cable length 线材长度	Contacts 芯数	Wire diameter 线径	PVC	TPE
0.1M	3pins	0.25mm ²	080103-04-811	080103-04-821
	4pins	0.25mm ²	080104-04-811	080104-04-821
0.2M	3pins	0.25mm ²	080103-04-812	080103-04-822
	4pins	0.25mm ²	080104-04-812	080104-04-822
0.5M	3pins	0.25mm ²	080103-04-813	080103-04-823
	4pins	0.25mm ²	080104-04-813	080104-04-823
1.0M	3pins	0.25mm ²	080103-04-814	080103-04-824
	4pins	0.25mm ²	080104-04-814	080104-04-824

Specification/技术参数

Number of contacts/芯数	3	4
Rated voltage/额定电压	50V AC / 60V DC	
Rated current (40°C)/额定电流	3A	
Protection degree/防护等级	IP67/IP68	
Operating temperature/工作温度	-25°C ~ +80°C	

Male cable

Product figure



Scale diagram

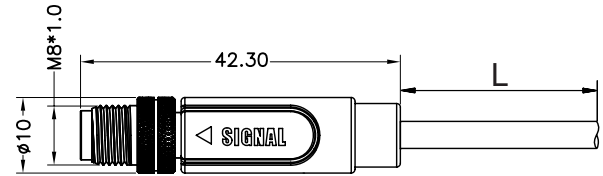

Contact layout/针孔排布(Front view/前视图)

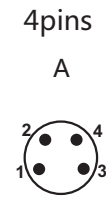
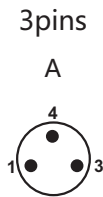

Circuit diagram/电路图

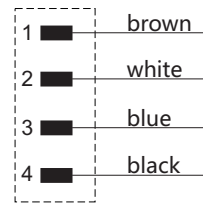
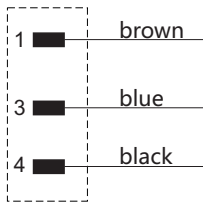

Order No/订货号

Cable length 线材长度	Contacts 芯数	Wire diameter 线径	PVC		PUR	
			black/黑色	gray/灰色	black/黑色	gray/灰色
1.5M	3pins	0.25mm ²	080103-05-601	080103-05-641	080103-05-621	080103-05-661
	4pins	0.25mm ²	080104-05-601	080104-05-641	080104-05-621	080104-05-661
3.0M	3pins	0.25mm ²	080103-05-602	080103-05-642	080103-05-622	080103-05-662
	4pins	0.25mm ²	080104-05-602	080104-05-642	080104-05-622	080104-05-662
5.0M	3pins	0.25mm ²	080103-05-603	080103-05-643	080103-05-623	080103-05-663
	4pins	0.25mm ²	080104-05-603	080104-05-643	080104-05-623	080104-05-663
7.5M	3pins	0.25mm ²	080103-05-604	080103-05-644	080103-05-624	080103-05-664
	4pins	0.25mm ²	080104-05-604	080104-05-644	080104-05-624	080104-05-664
10M	3pins	0.25mm ²	080103-05-605	080103-05-645	080103-05-625	080103-05-665
	4pins	0.25mm ²	080104-05-605	080104-05-645	080104-05-625	080104-05-665

Specification/技术参数

Number of contacts/芯数	3	4
Rated voltage/额定电压	50V AC / 60V DC	
Rated current (40°C)/额定电流	3A	
Protection degree/防护等级	IP67/IP68	
Operating temperature/工作温度	-25°C ~ +80°C	
Cable OD /线材直径	4.6mm	4.6~5.0mm

M8 Circular connectors

Male cable

Product figure



Scale diagram

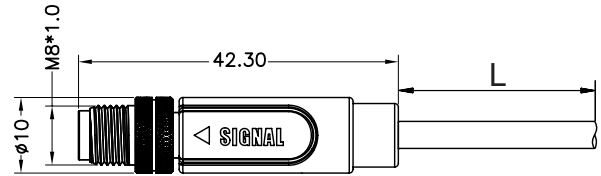

Contact layout/针孔排布(Front view/前视图)



Circuit diagram/电路图

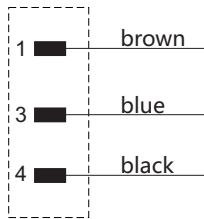

Order No/订货号

Cable length 线材长度	Contacts 芯数	Wire diameter 线径	PUR
			black/黑色
1.5M	3pins	0.34mm ²	080103-05-691
3.0M	3pins	0.34mm ²	080103-05-692
5.0M	3pins	0.34mm ²	080103-05-693
7.5M	3pins	0.34mm ²	080103-05-694
10M	3pins	0.34mm ²	080103-05-695

Specification/技术参数

Number of contacts/芯数	3
Rated voltage/额定电压	50V AC / 60V DC
Rated current (40°C)/额定电流	3A
Protection degree/防护等级	IP67/IP68
Operating temperature/工作温度	-25°C ~ +80°C
Cable OD /线材直径	4.5~5.0mm

M8 Circular connectors

Female cable

Product figure



Scale diagram

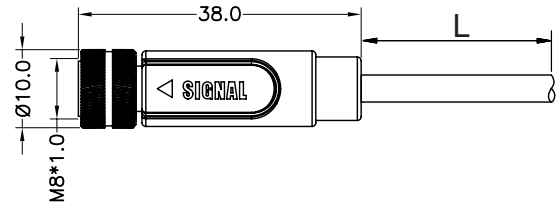

Contact layout/针孔排布(Front view/前视图)

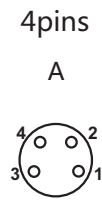
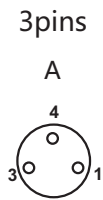

Circuit diagram/电路图

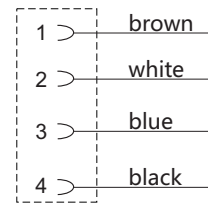
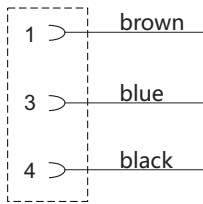

Order No/订货号

Cable length 线材长度	Contacts 芯数	Wire diameter 线径	PVC		PUR	
			black/黑色	gray/灰色	black/黑色	gray/灰色
1.5M	3pins	0.25mm ²	080103-06-601	080103-06-641	080103-06-621	080103-06-661
	4pins	0.25mm ²	080104-06-601	080104-06-641	080104-06-621	080104-06-661
3.0M	3pins	0.25mm ²	080103-06-602	080103-06-642	080103-06-622	080103-06-662
	4pins	0.25mm ²	080104-06-602	080104-06-642	080104-06-622	080104-06-662
5.0M	3pins	0.25mm ²	080103-06-603	080103-06-643	080103-06-623	080103-06-663
	4pins	0.25mm ²	080104-06-603	080104-06-643	080104-06-623	080104-06-663
7.5M	3pins	0.25mm ²	080103-06-604	080103-06-644	080103-06-624	080103-06-664
	4pins	0.25mm ²	080104-06-604	080104-06-644	080104-06-624	080104-06-664
10M	3pins	0.25mm ²	080103-06-605	080103-06-645	080103-06-625	080103-06-665
	4pins	0.25mm ²	080104-06-605	080104-06-645	080104-06-625	080104-06-665

Specification/技术参数

Number of contacts/芯数	3	4
Rated voltage/额定电压	50V AC / 60V DC	
Rated current (40°C)/额定电流	3A	
Protection degree/防护等级	IP67/IP68	
Operating temperature/工作温度	-25°C ~ +80°C	
Cable OD /线材直径	4.6mm	4.6~5.0mm

M8 Circular connectors

Female cable

Product figure



Scale diagram

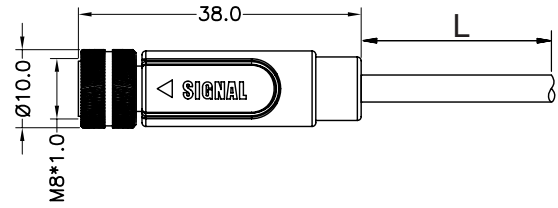

Contact layout/针孔排布(Front view/前视图)

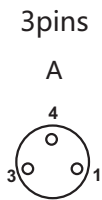

Circuit diagram/电路图

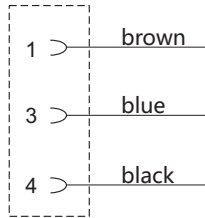

Order No/订货号

Cable length 线材长度	Contacts 芯数	Wire diameter 线径	PVC gray/灰色
1.5M	3pins	0.34mm ²	080103-05-691
3.0M	3pins	0.34mm ²	080103-05-692
5.0M	3pins	0.34mm ²	080103-05-693
7.5M	3pins	0.34mm ²	080103-05-694
10M	3pins	0.34mm ²	080103-05-695

Specification/技术参数

Number of contacts/芯数	3
Rated voltage/额定电压	50V AC / 60V DC
Rated current (40°C)/额定电流	3A
Protection degree/防护等级	IP67/IP68
Operating temperature/工作温度	-25°C ~ +80°C
Cable OD /线材直径	4.5~5.0mm

Male cable(90°)

Product figure



Scale diagram

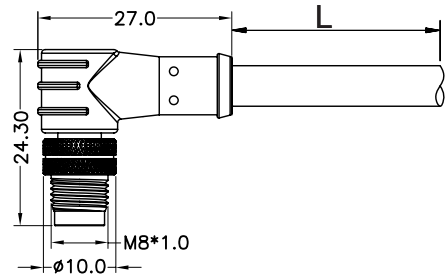

Contact layout/针孔排布(Front view/前视图)

3pins

A

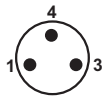

4pins

A



Circuit diagram/电路图

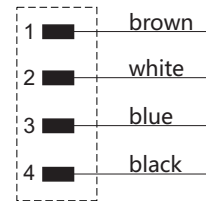
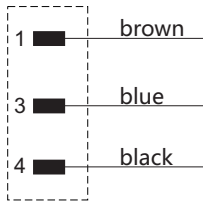

Order No/订货号

Cable length 线材长度	Contacts 芯数	Wire diameter 线径	PVC		PUR	
			black/黑色	gray/灰色	black/黑色	gray/灰色
1.5M	3pins	0.25mm ²	080103-05-901	080103-05-941	080103-05-921	080103-05-961
	4pins	0.25mm ²	080104-05-901	080104-05-941	080104-05-921	080104-05-961
3.0M	3pins	0.25mm ²	080103-05-902	080103-05-942	080103-05-922	080103-05-962
	4pins	0.25mm ²	080104-05-902	080104-05-942	080104-05-922	080104-05-962
5.0M	3pins	0.25mm ²	080103-05-903	080103-05-943	080103-05-923	080103-05-963
	4pins	0.25mm ²	080104-05-903	080104-05-943	080104-05-923	080104-05-963
7.5M	3pins	0.25mm ²	080103-05-904	080103-05-944	080103-05-924	080103-05-964
	4pins	0.25mm ²	080104-05-904	080104-05-944	080104-05-924	080104-05-964
10M	3pins	0.25mm ²	080103-05-905	080103-05-945	080103-05-925	080103-05-965
	4pins	0.25mm ²	080104-05-905	080104-05-945	080104-05-925	080104-05-965

Specification/技术参数

Number of contacts/芯数	3	4
Rated voltage/额定电压	50V AC / 60V DC	
Rated current (40°C)/额定电流	3A	
Protection degree/防护等级	IP67/IP68	
Operating temperature/工作温度	-25°C ~ +80°C	
Cable OD /线材直径	4.6mm	4.6~5.0mm

M8 Circular connectors

Female cable(90°)

Product figure



Scale diagram

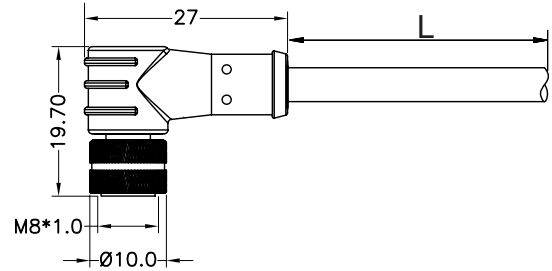

Contact layout/针孔排布(Front view/前视图)

3pins

A



4pins

A

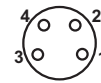

Circuit diagram/电路图

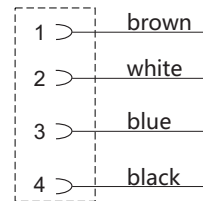
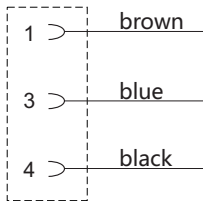

Order No/订货号

Cable length 线材长度	Contacts 芯数	Wire diameter 线径	PVC		PUR	
			black/黑色	gray/灰色	black/黑色	gray/灰色
1.5M	3pins	0.25mm ²	080103-06-901	080103-06-941	080103-06-921	080103-06-961
	4pins	0.25mm ²	080104-06-901	080104-06-941	080104-06-921	080104-06-961
3.0M	3pins	0.25mm ²	080103-06-902	080103-06-942	080103-06-922	080103-06-962
	4pins	0.25mm ²	080104-06-902	080104-06-942	080104-06-922	080104-06-962
5.0M	3pins	0.25mm ²	080103-06-903	080103-06-943	080103-06-923	080103-06-963
	4pins	0.25mm ²	080104-06-903	080104-06-943	080104-06-923	080104-06-963
7.5M	3pins	0.25mm ²	080103-06-904	080103-06-944	080103-06-924	080103-06-964
	4pins	0.25mm ²	080104-06-904	080104-06-944	080104-06-924	080104-06-964
10M	3pins	0.25mm ²	080103-06-905	080103-06-945	080103-06-925	080103-06-965
	4pins	0.25mm ²	080104-06-905	080104-06-945	080104-06-925	080104-06-965

Specification/技术参数

Number of contacts/芯数	3	4
Rated voltage/额定电压	50V AC / 60V DC	
Rated current (40°C)/额定电流	3A	
Protection degree/防护等级	IP67/IP68	
Operating temperature/工作温度	-25°C ~ +80°C	
Cable OD /线材直径	4.6mm	4.6~5.0mm

Male cable(with LED PNP)

Product figure



Scale diagram

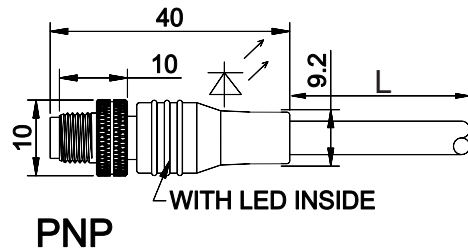

Contact layout/针孔排布(Front view/前视图)

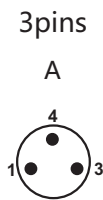

Circuit diagram/电路图

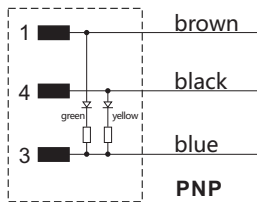

Order No/订货号

Cable length 线材长度	Contacts 芯数	0.25mm ²
1.5M	3pins	080103-05-680
3.0M	3pins	080103-05-681
5.0M	3pins	080103-05-682
7.5M	3pins	080103-05-683
10M	3pins	080103-05-684

Specification/技术参数

Number of contacts/芯数	3
Rated voltage/额定电压	50V AC / 60V DC
Rated current (40°C)/额定电流	3A
Protection degree/防护等级	IP67/IP68
Operating temperature/工作温度	-25°C ~ +80°C
Cable OD /线材直径	4.6mm

M8 Circular connectors

Male cable(with LED NPN)

Product figure



Scale diagram

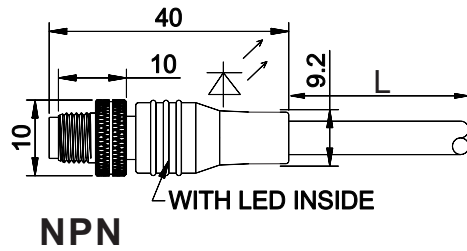

Contact layout/针孔排布(Front view/前视图)

4pins

A



Circuit diagram/电路图

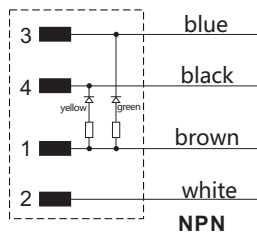

Order No/订货号

Cable length 线材长度	Contacts 芯数	0.25mm ²
1.5M	4pins	080104-05-680
3.0M	4pins	080104-05-681
5.0M	4pins	080104-05-682
7.5M	4pins	080104-05-683
10M	4pins	080104-05-684

Specification/技术参数

Number of contacts/芯数	4
Rated voltage/额定电压	50V AC / 60V DC
Rated current (40°C)/额定电流	3A
Protection degree/防护等级	IP67/IP68
Operating temperature/工作温度	-25°C ~ +80°C
Cable OD /线材直径	4.6~5.0mm

Female cable(with LED PNP)

Product figure



Scale diagram

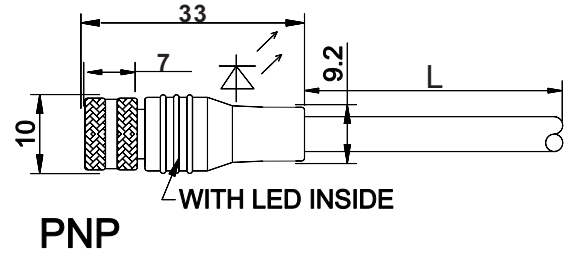

Contact layout/针孔排布(Front view/前视图)

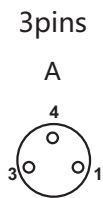

Circuit diagram/电路图

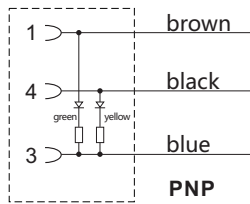

Order No/订货号

Cable length 线材长度	Contacts 芯数	0.25mm ²
1.5M	3pins	080103-06-680
3.0M	3pins	080103-06-681
5.0M	3pins	080103-06-682
7.5M	3pins	080103-06-683
10M	3pins	080103-06-684

Specification/技术参数

Number of contacts/芯数	3
Rated voltage/额定电压	50V AC / 60V DC
Rated current (40°C)/额定电流	3A
Protection degree/防护等级	IP67/IP68
Operating temperature/工作温度	-25°C ~ +80°C
Cable OD /线材直径	4.6mm

M8 Circular connectors

Female cable(with LED NPN)

Product figure



Scale diagram

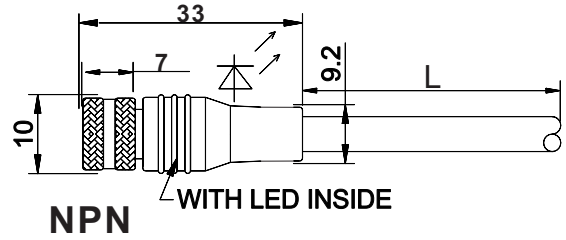

Contact layout/针孔排布(Front view/前视图)

4pins

A



Circuit diagram/电路图

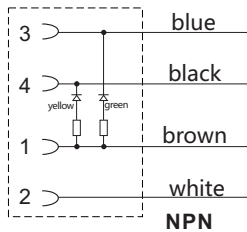

Order No/订货号

Cable length 线材长度	Contacts 芯数	0.25mm ²
1.5M	4pins	080104-06-680
3.0M	4pins	080104-06-681
5.0M	4pins	080104-06-682
7.5M	4pins	080104-06-683
10M	4pins	080104-06-684

Specification/技术参数

Number of contacts/芯数	4
Rated voltage/额定电压	50V AC / 60V DC
Rated current (40°C)/额定电流	3A
Protection degree/防护等级	IP67/IP68
Operating temperature/工作温度	-25°C ~ +80°C
Cable OD /线材直径	4.6~5.0mm

Male cable(90° with LED PNP)

Product figure



Scale diagram

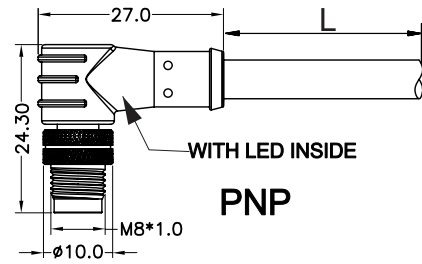

Contact layout/针孔排布(Front view/前视图)

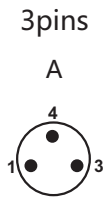

Circuit diagram/电路图

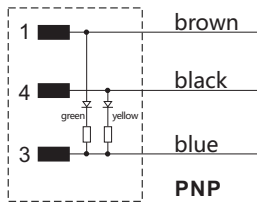

Order No/订货号

Cable length 线材长度	Contacts 芯数	0.25mm ²
1.5M	3pins	080103-05-980
3.0M	3pins	080103-05-981
5.0M	3pins	080103-05-982
7.5M	3pins	080103-05-983
10M	3pins	080103-05-984

Specification/技术参数

Number of contacts/芯数	3
Rated voltage/额定电压	50V AC / 60V DC
Rated current (40°C)/额定电流	3A
Protection degree/防护等级	IP67/IP68
Operating temperature/工作温度	-25°C ~ +80°C
Cable OD /线材直径	4.6mm

M8 Circular connectors

Male cable(90° with LED NPN)

Product figure



Scale diagram

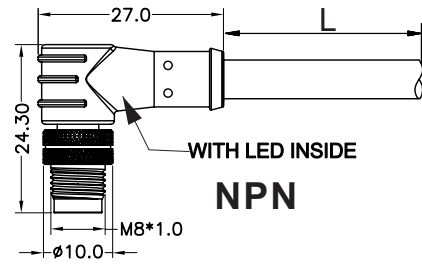

Contact layout/针孔排布(Front view/前视图)

4pins

A



Circuit diagram/电路图

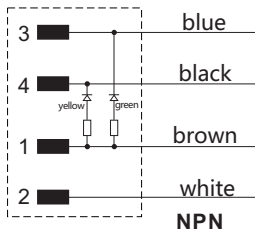

Order No/订货号

Cable length 线材长度	Contacts 芯数	0.25mm ²
1.5M	4pins	080104-05-980
3.0M	4pins	080104-05-981
5.0M	4pins	080104-05-982
7.5M	4pins	080104-05-983
10M	4pins	080104-05-984

Specification/技术参数

Number of contacts/芯数	4
Rated voltage/额定电压	50V AC / 60V DC
Rated current (40°C)/额定电流	3A
Protection degree/防护等级	IP67/IP68
Operating temperature/工作温度	-25°C ~ +80°C
Cable OD /线材直径	4.6~5.0mm

M8 Circular connectors

Female cable(90° with LED PNP)

Product figure



Scale diagram

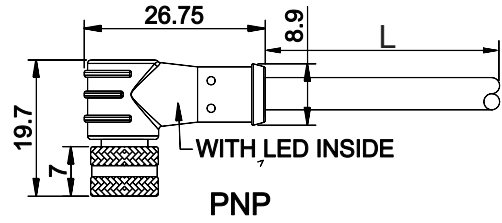

Contact layout/针孔排布(Front view/前视图)

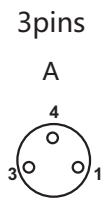

Circuit diagram/电路图

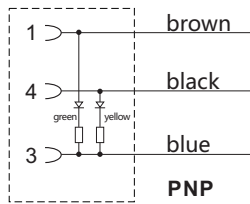

Order No/订货号

Cable length 线材长度	Contacts 芯数	0.25mm ²
1.5M	3pins	080103-06-980
3.0M	3pins	080103-06-981
5.0M	3pins	080103-06-982
7.5M	3pins	080103-06-983
10M	3pins	080103-06-984

Specification/技术参数

Number of contacts/芯数	3
Rated voltage/额定电压	50V AC / 60V DC
Rated current (40°C)/额定电流	3A
Protection degree/防护等级	IP67/IP68
Operating temperature/工作温度	-25°C ~ +80°C
Cable OD /线材直径	4.6mm

M8 Circular connectors

Female cable(90° with LED NPN)

Product figure



Scale diagram

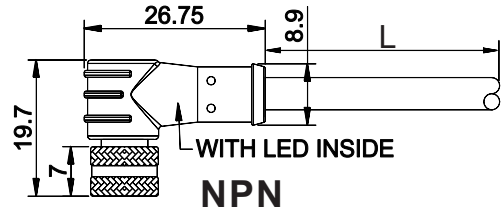

Contact layout/针孔排布(Front view/前视图)

4pins

A



Circuit diagram/电路图

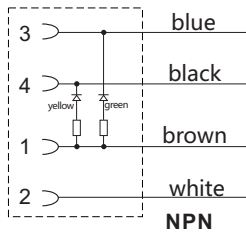

Order No/订货号

Cable length 线材长度	Contacts 芯数	0.25mm ²
1.5M	4pins	080104-06-980
3.0M	4pins	080104-06-981
5.0M	4pins	080104-06-982
7.5M	4pins	080104-06-983
10M	4pins	080104-06-984

Specification/技术参数

Number of contacts/芯数	4
Rated voltage/额定电压	50V AC / 60V DC
Rated current (40°C)/额定电流	3A
Protection degree/防护等级	IP67/IP68
Operating temperature/工作温度	-25°C ~ +80°C
Cable OD /线材直径	4.6~5.0mm

M8 Circular connectors

Male cable(with shield)

Product figure



Scale diagram

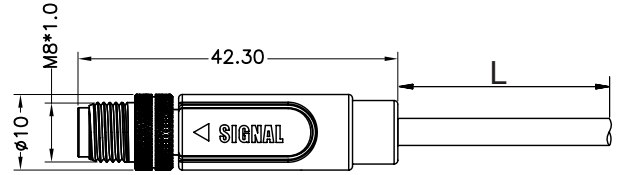

Contact layout/针孔排布(Front view/前视图)

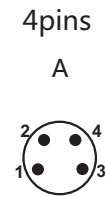
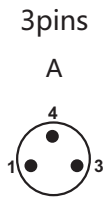

Circuit diagram/电路图

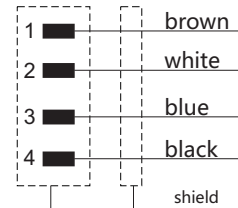
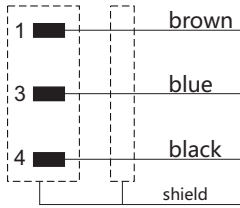

Order No/订货号

Cable length 线材长度	Contacts 芯数	Wire diameter 线径	PVC+AEB		PUR+AEB	
			black/黑色	gray/灰色	black/黑色	gray/灰色
1.5M	3pins	0.25mm ²	080103-05-611	080103-05-651	080103-05-631	080103-05-671
	4pins	0.25mm ²	080104-05-611	080104-05-651	080104-05-631	080104-05-671
3.0M	3pins	0.25mm ²	080103-05-612	080103-05-652	080103-05-632	080103-05-672
	4pins	0.25mm ²	080104-05-612	080104-05-652	080104-05-632	080104-05-672
5.0M	3pins	0.25mm ²	080103-05-613	080103-05-653	080103-05-633	080103-05-673
	4pins	0.25mm ²	080104-05-613	080104-05-653	080104-05-633	080104-05-673
7.5M	3pins	0.25mm ²	080103-05-614	080103-05-654	080103-05-634	080103-05-674
	4pins	0.25mm ²	080104-05-614	080104-05-654	080104-05-634	080104-05-674
10M	3pins	0.25mm ²	080103-05-615	080103-05-655	080103-05-635	080103-05-675
	4pins	0.25mm ²	080104-05-615	080104-05-655	080104-05-635	080104-05-675

Specification/技术参数

Number of contacts/芯数	3	4
Rated voltage/额定电压	50V AC / 60V DC	
Rated current (40°C)/额定电流	3A	
Protection degree/防护等级	IP67/IP68	
Operating temperature/工作温度	-25°C ~ +80°C	
Cable OD /线材直径	4.6mm	4.6~5.0mm

M8 Circular connectors

Female cable(with shield)

Product figure



Scale diagram

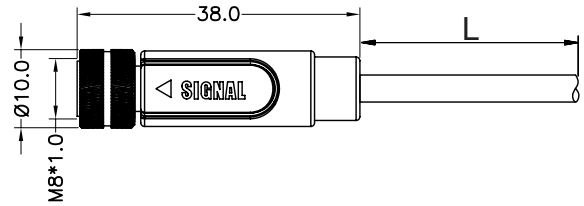

Contact layout/针孔排布(Front view/前视图)

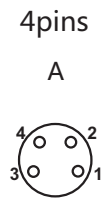
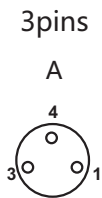

Circuit diagram/电路图

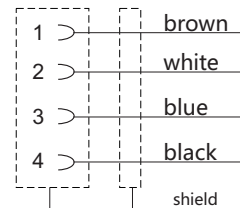
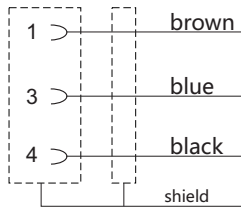

Order No/订货号

Cable length 线材长度	Contacts 芯数	Wire diameter 线径	PVC+AEB		PUR+AEB	
			black/黑色	gray/灰色	black/黑色	gray/灰色
1.5M	3pins	0.25mm ²	080103-06-611	080103-06-651	080103-06-631	080103-06-671
	4pins	0.25mm ²	080104-06-611	080104-06-651	080104-06-631	080104-06-671
3.0M	3pins	0.25mm ²	080103-06-612	080103-06-652	080103-06-632	080103-06-672
	4pins	0.25mm ²	080104-06-612	080104-06-652	080104-06-632	080104-06-672
5.0M	3pins	0.25mm ²	080103-06-613	080103-06-653	080103-06-633	080103-06-673
	4pins	0.25mm ²	080104-06-613	080104-06-653	080104-06-633	080104-06-673
7.5M	3pins	0.25mm ²	080103-06-614	080103-06-654	080103-06-634	080103-06-674
	4pins	0.25mm ²	080104-06-614	080104-06-654	080104-06-634	080104-06-674
10M	3pins	0.25mm ²	080103-06-615	080103-06-655	080103-06-635	080103-06-675
	4pins	0.25mm ²	080104-06-615	080104-06-655	080104-06-635	080104-06-675

Specification/技术参数

Number of contacts/芯数	3	4
Rated voltage/额定电压	50V AC / 60V DC	
Rated current (40°C)/额定电流	3A	
Protection degree/防护等级	IP67/IP68	
Operating temperature/工作温度	-25°C ~ +80°C	
Cable OD /线材直径	4.6mm	4.6~5.0mm

Male cable(90° with shield)

Product figure



Scale diagram

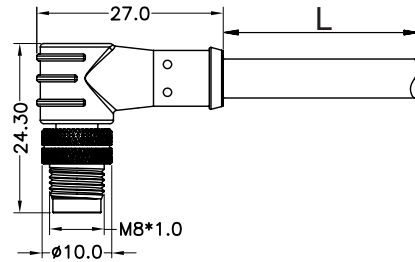

Contact layout/针孔排布(Front view/前视图)

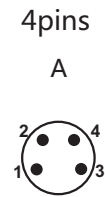
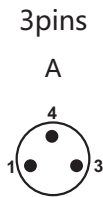

Circuit diagram/电路图

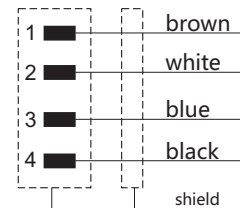
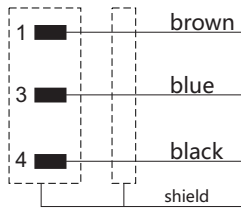

Order No/订货号

Cable length 线材长度	Contacts 芯数	Wire diameter 线径	PVC+AEB		PUR+AEB	
			black/黑色	gray/灰色	black/黑色	gray/灰色
1.5M	3pins	0.25mm ²	080103-05-911	080103-05-951	080103-05-931	080103-05-971
	4pins	0.25mm ²	080104-05-911	080104-05-951	080104-05-931	080104-05-971
3.0M	3pins	0.25mm ²	080103-05-912	080103-05-952	080103-05-932	080103-05-972
	4pins	0.25mm ²	080104-05-912	080104-05-952	080104-05-932	080104-05-972
5.0M	3pins	0.25mm ²	080103-05-913	080103-05-953	080103-05-933	080103-05-973
	4pins	0.25mm ²	080104-05-913	080104-05-953	080104-05-933	080104-05-973
7.5M	3pins	0.25mm ²	080103-05-914	080103-05-954	080103-05-934	080103-05-974
	4pins	0.25mm ²	080104-05-914	080104-05-954	080104-05-934	080104-05-974
10M	3pins	0.25mm ²	080103-05-915	080103-05-955	080103-05-935	080103-05-975
	4pins	0.25mm ²	080104-05-915	080104-05-955	080104-05-935	080104-05-975

Specification/技术参数

Number of contacts/芯数	3	4
Rated voltage/额定电压	50V AC / 60V DC	
Rated current (40°C)/额定电流	3A	
Protection degree/防护等级	IP67/IP68	
Operating temperature/工作温度	-25°C ~ +80°C	
Cable OD /线材直径	4.6mm	4.6~5.0mm

M8 Circular connectors

Female cable(90° with shield)

Product figure



Scale diagram

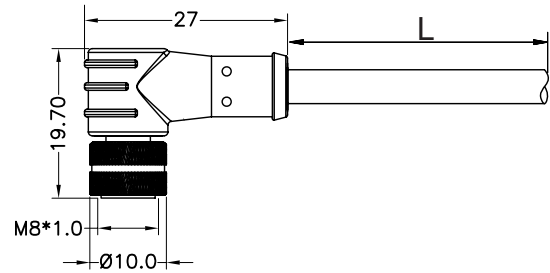

Contact layout/针孔排布(Front view/前视图)

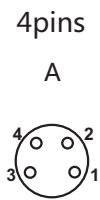
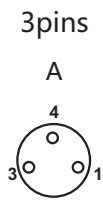

Circuit diagram/电路图

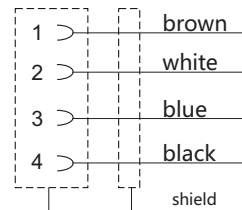
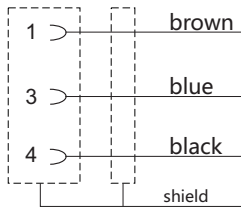

Order No/订货号

Cable length 线材长度	Contacts 芯数	Wire diameter 线径	PVC+AEB		PUR+AEB	
			black/黑色	gray/灰色	black/黑色	gray/灰色
1.5M	3pins	0.25mm ²	080103-06-911	080103-06-951	080103-06-931	080103-06-971
	4pins	0.25mm ²	080104-06-911	080104-06-951	080104-06-931	080104-06-971
3.0M	3pins	0.25mm ²	080103-06-912	080103-06-952	080103-06-932	080103-06-972
	4pins	0.25mm ²	080104-06-912	080104-06-952	080104-06-932	080104-06-972
5.0M	3pins	0.25mm ²	080103-06-913	080103-06-953	080103-06-933	080103-06-973
	4pins	0.25mm ²	080104-06-913	080104-06-953	080104-06-933	080104-06-973
7.5M	3pins	0.25mm ²	080103-06-914	080103-06-954	080103-06-934	080103-06-974
	4pins	0.25mm ²	080104-06-914	080104-06-954	080104-06-934	080104-06-974
10M	3pins	0.25mm ²	080103-06-915	080103-06-955	080103-06-935	080103-06-975
	4pins	0.25mm ²	080104-06-915	080104-06-955	080104-06-935	080104-06-975

Specification/技术参数

Number of contacts/芯数	3	4
Rated voltage/额定电压	50V AC / 60V DC	
Rated current (40°C)/额定电流	3A	
Protection degree/防护等级	IP67/IP68	
Operating temperature/工作温度	-25°C ~ +80°C	
Cable OD /线材直径	4.6mm	4.6~5.0mm

Male to female cable

Product figure(M8-M8)



Scale diagram

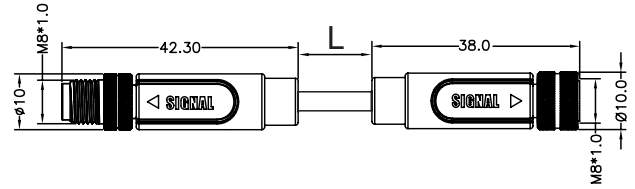

Contact layout/针孔排布(Front view/前视图)

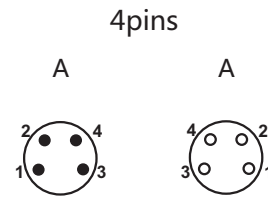
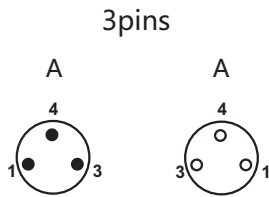

Circuit diagram/电路图

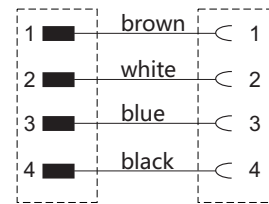
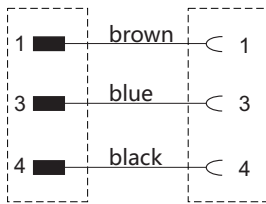

Order No/订货号

Cable length 线材长度	Contacts 芯数	Wire diameter 线径	PVC		PUR	
			black/黑色	gray/灰色	black/黑色	gray/灰色
0.3M	3pins	0.25mm ²	080103-56-601	080103-56-641	080103-56-621	080103-56-661
	4pins	0.25mm ²	080104-56-601	080104-56-641	080104-56-621	080104-56-661
0.6M	3pins	0.25mm ²	080103-56-602	080103-56-642	080103-56-622	080103-56-662
	4pins	0.25mm ²	080104-56-602	080104-56-642	080104-56-622	080104-56-662
1.0M	3pins	0.25mm ²	080103-56-603	080103-56-643	080103-56-623	080103-56-663
	4pins	0.25mm ²	080104-56-603	080104-56-643	080104-56-623	080104-56-663
2.0M	3pins	0.25mm ²	080103-56-604	080103-56-644	080103-56-624	080103-56-664
	4pins	0.25mm ²	080104-56-604	080104-56-644	080104-56-624	080104-56-664

Specification/技术参数

Number of contacts/芯数	3	4
Rated voltage/额定电压	50V AC / 60V DC	
Rated current (40°C)/额定电流	3A	
Protection degree/防护等级	IP67/IP68	
Operating temperature/工作温度	-25°C ~ +80°C	
Cable OD /线材直径	4.6mm	4.6~5.0mm

M8 Circular connectors

Male to female cable

Product figure(M8-M8)



Scale diagram

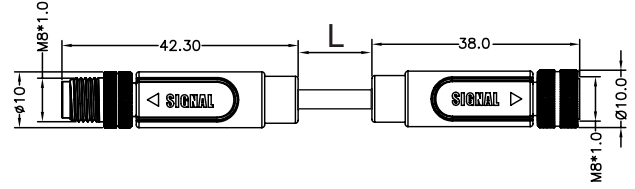

Contact layout/针孔排布(Front view/前视图)

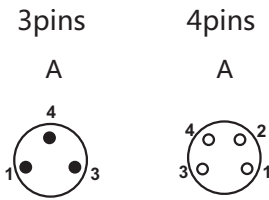

Circuit diagram/电路图

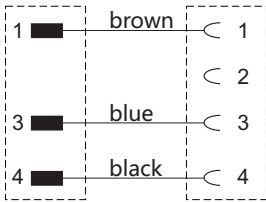

Order No/订货号

Cable length 线材长度	Contacts 芯数	Wire diameter 线径	PVC		PUR	
			black/黑色	gray/灰色	black/黑色	gray/灰色
0.3M	3-4pins	0.25mm ²	080134-56-601	080134-56-641	080134-56-621	080134-56-661
0.6M	3-4pins	0.25mm ²	080134-56-602	080134-56-642	080134-56-622	080134-56-662
1.0M	3-4pins	0.25mm ²	080134-56-603	080134-56-643	080134-56-623	080134-56-663
2.0M	3-4pins	0.25mm ²	080134-56-604	080134-56-644	080134-56-624	080134-56-664

Specification/技术参数

Number of contacts/芯数	3-4
Rated voltage/额定电压	50V AC / 60V DC
Rated current (40°C)/额定电流	3A
Protection degree/防护等级	IP67/IP68
Operating temperature/工作温度	-25°C ~ +80°C
Cable OD /线材直径	4.6~5.0mm

M8 Circular connectors

Male to R/A female cable

Product figure(M8-M8)



Scale diagram

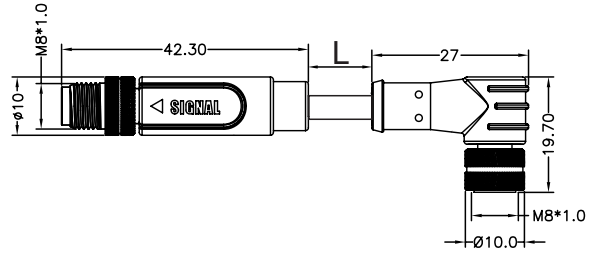

Contact layout/针孔排布(Front view/前视图)



Circuit diagram/电路图



Order No/订货号

Cable length 线材长度	Contacts 芯数	Wire diameter 线径	PVC		PUR	
			black/黑色	gray/灰色	black/黑色	gray/灰色
0.3M	3pins	0.25mm ²	080103-56-701	080103-56-741	080103-56-721	080103-56-761
	4pins	0.25mm ²	080104-56-701	080104-56-741	080104-56-721	080104-56-761
0.6M	3pins	0.25mm ²	080103-56-702	080103-56-742	080103-56-722	080103-56-762
	4pins	0.25mm ²	080104-56-702	080104-56-742	080104-56-722	080104-56-762
1.0M	3pins	0.25mm ²	080103-56-703	080103-56-743	080103-56-723	080103-56-763
	4pins	0.25mm ²	080104-56-703	080104-56-743	080104-56-723	080104-56-763
2.0M	3pins	0.25mm ²	080103-56-704	080103-56-744	080103-56-724	080103-56-764
	4pins	0.25mm ²	080104-56-704	080104-56-744	080104-56-724	080104-56-764

Specification/技术参数

Number of contacts/芯数	3	4
Rated voltage/额定电压	50V AC / 60V DC	
Rated current (40°C)/额定电流	3A	
Protection degree/防护等级	IP67/IP68	
Operating temperature/工作温度	-25°C ~ +80°C	
Cable OD /线材直径	4.6mm	4.6~5.0mm

M8 Circular connectors

Male to R/A female cable

Product figure(M8-M8)



Scale diagram

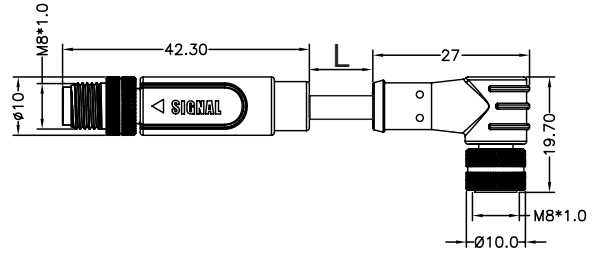

Contact layout/针孔排布(Front view/前视图)

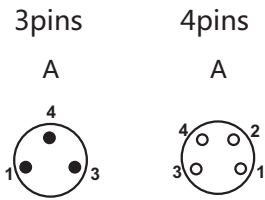

Circuit diagram/电路图

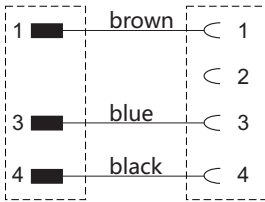

Order No/订货号

Cable length 线材长度	Contacts 芯数	Wire diameter 线径	PVC		PUR	
			black/黑色	gray/灰色	black/黑色	gray/灰色
0.3M	3-4pins	0.25mm ²	080134-56-701	080134-56-741	080134-56-721	080134-56-761
0.6M	3-4pins	0.25mm ²	080134-56-702	080134-56-742	080134-56-722	080134-56-762
1.0M	3-4pins	0.25mm ²	080134-56-703	080134-56-743	080134-56-723	080134-56-763
2.0M	3-4pins	0.25mm ²	080134-56-704	080134-56-744	080134-56-724	080134-56-764

Specification/技术参数

Number of contacts/芯数	3-4
Rated voltage/额定电压	50V AC / 60V DC
Rated current (40°C)/额定电流	3A
Protection degree/防护等级	IP67/IP68
Operating temperature/工作温度	-25°C ~ +80°C
Cable OD /线材直径	4.6~5.0mm

M8 Circular connectors

R/A male to female cable

Product figure(M8-M8)



Scale diagram

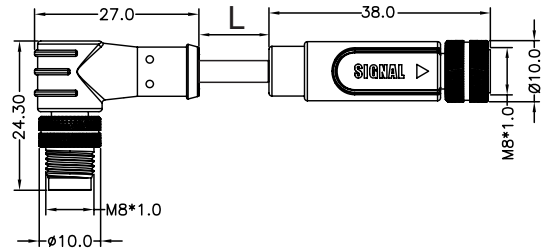

Contact layout/针孔排布(Front view/前视图)

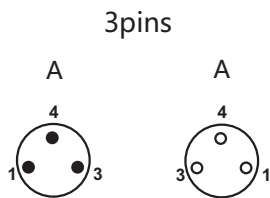

Circuit diagram/电路图

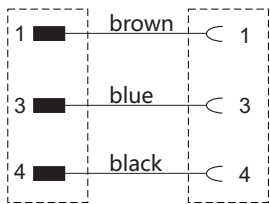

Order No/订货号

Cable length 线材长度	Contacts 芯数	Wire diameter 线径	PVC		PUR	
			black/黑色	gray/灰色	black/黑色	gray/灰色
0.3M	3pins	0.25mm ²	080103-56-801	080103-56-841	080103-56-821	080103-56-861
0.6M	3pins	0.25mm ²	080103-56-802	080103-56-842	080103-56-822	080103-56-862
1.0M	3pins	0.25mm ²	080103-56-803	080103-56-843	080103-56-823	080103-56-863
2.0M	3pins	0.25mm ²	080103-56-804	080103-56-844	080103-56-824	080103-56-864

Specification/技术参数

Number of contacts/芯数	3
Rated voltage/额定电压	50V AC / 60V DC
Rated current (40°C)/额定电流	3A
Protection degree/防护等级	IP67/IP68
Operating temperature/工作温度	-25°C ~ +80°C
Cable OD /线材直径	4.6mm

M8 Circular connectors

Male to R/A female cable(with LED PNP)

Product figure(M8-M8)



Scale diagram

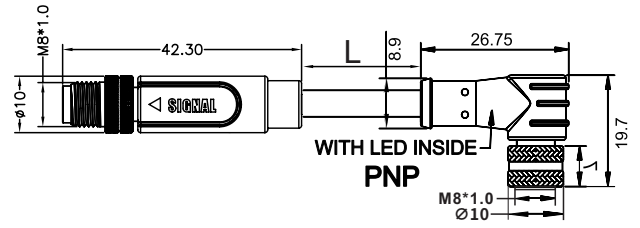

Contact layout/针孔排布(Front view/前视图)

3pins

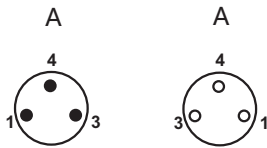

Circuit diagram/电路图

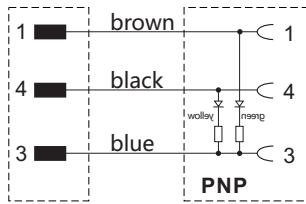

Order No/订货号

Cable length 线材长度	Contacts 芯数	0.25mm ²
0.3M	3pins	080103-56-780
0.6M	3pins	080103-56-781
1.0M	3pins	080103-56-782
2.0M	3pins	080103-56-783

Specification/技术参数

Number of contacts/芯数	3
Rated voltage/额定电压	50V AC / 60V DC
Rated current (40°C)/额定电流	3A
Protection degree/防护等级	IP67/IP68
Operating temperature/工作温度	-25°C ~ +80°C
Cable OD /线材直径	4.6mm

M8 Circular connectors

Male to female cable(with shield)

Product figure(M8-M8)



Scale diagram

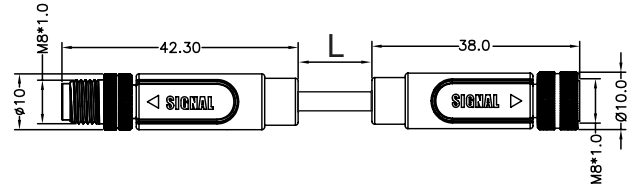

Contact layout/针孔排布(Front view/前视图)



Circuit diagram/电路图



Order No/订货号

Cable length 线材长度	Contacts 芯数	Wire diameter 线径	PVC+AEB		PUR+AEB	
			black/黑色	gray/灰色	black/黑色	gray/灰色
0.3M	3pins	0.25mm ²	080103-56-611	080103-56-651	080103-56-631	080103-56-671
	4pins	0.25mm ²	080104-56-611	080104-56-651	080104-56-631	080104-56-671
0.6M	3pins	0.25mm ²	080103-56-612	080103-56-652	080103-56-632	080103-56-672
	4pins	0.25mm ²	080104-56-612	080104-56-652	080104-56-632	080104-56-672
1.0M	3pins	0.25mm ²	080103-56-613	080103-56-653	080103-56-633	080103-56-673
	4pins	0.25mm ²	080104-56-613	080104-56-653	080104-56-633	080104-56-673
2.0M	3pins	0.25mm ²	080103-56-614	080103-56-654	080103-56-634	080103-56-674
	4pins	0.25mm ²	080104-56-614	080104-56-654	080104-56-634	080104-56-674

Specification/技术参数

Number of contacts/芯数	3	4
Rated voltage/额定电压	50V AC / 60V DC	
Rated current (40°C)/额定电流	3A	
Protection degree/防护等级	IP67/IP68	
Operating temperature/工作温度	-25°C ~ +80°C	
Cable OD /线材直径	4.6mm	4.6~5.0mm

M8 Circular connectors

Male to female cable

Product figure(M8-M12)



Scale diagram

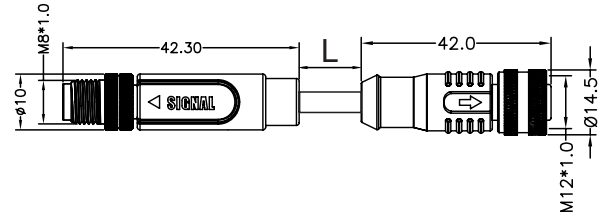

Contact layout/针孔排布(Front view/前视图)



Circuit diagram/电路图



Order No/订货号

Cable length 线材长度	Contacts 芯数	Wire diameter 线径	PVC		PUR	
			black/黑色	gray/灰色	black/黑色	gray/灰色
0.3M	3pins	0.25mm ²	820103-56-601	820103-56-641	820103-56-621	820103-56-661
	4pins	0.25mm ²	820104-56-601	820104-56-641	820104-56-621	820104-56-661
0.6M	3pins	0.25mm ²	820103-56-602	820103-56-642	820103-56-622	820103-56-662
	4pins	0.25mm ²	820104-56-602	820104-56-642	820104-56-622	820104-56-662
1.0M	3pins	0.25mm ²	820103-56-603	820103-56-643	820103-56-623	820103-56-663
	4pins	0.25mm ²	820104-56-603	820104-56-643	820104-56-623	820104-56-663
2.0M	3pins	0.25mm ²	820103-56-604	820103-56-644	820103-56-624	820103-56-664
	4pins	0.25mm ²	820104-56-604	820104-56-644	820104-56-624	820104-56-664

Specification/技术参数

Number of contacts/芯数	3	4
Rated voltage/额定电压	50V AC / 60V DC	
Rated current (40°C)/额定电流	3A	
Protection degree/防护等级	IP67/IP68	
Operating temperature/工作温度	-25°C ~ +80°C	
Cable OD /线材直径	4.6mm	4.6~5.0mm

Male to R/A female cable

Product figure(M8-M12)



Scale diagram

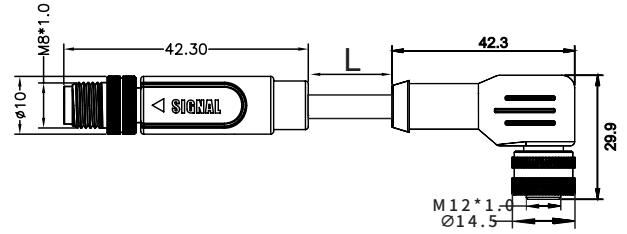

Contact layout/针孔排布(Front view/前视图)



Circuit diagram/电路图



Order No/订货号

Cable length 线材长度	Contacts 芯数	Wire diameter 线径	PVC		PUR	
			black/黑色	gray/灰色	black/黑色	gray/灰色
0.3M	3pins	0.25mm ²	820103-56-701	820103-56-741	820103-56-721	820103-56-761
	4pins	0.25mm ²	820104-56-701	820104-56-741	820104-56-721	820104-56-761
0.6M	3pins	0.25mm ²	820103-56-702	820103-56-742	820103-56-722	820103-56-762
	4pins	0.25mm ²	820104-56-702	820104-56-742	820104-56-722	820104-56-762
1.0M	3pins	0.25mm ²	820103-56-703	820103-56-743	820103-56-723	820103-56-763
	4pins	0.25mm ²	820104-56-703	820104-56-743	820104-56-723	820104-56-763
2.0M	3pins	0.25mm ²	820103-56-704	820103-56-744	820103-56-724	820103-56-764
	4pins	0.25mm ²	820104-56-704	820104-56-744	820104-56-724	820104-56-764

Specification/技术参数

Number of contacts/芯数	3	4
Rated voltage/额定电压	50V AC / 60V DC	
Rated current (40°C)/额定电流	3A	
Protection degree/防护等级	IP67/IP68	
Operating temperature/工作温度	-25°C ~ +80°C	
Cable OD /线材直径	4.6mm	4.6~5.0mm

M8 Circular connectors

Male to R/A female cable(with LED PNP)

Product figure(M8-M12)



Scale diagram

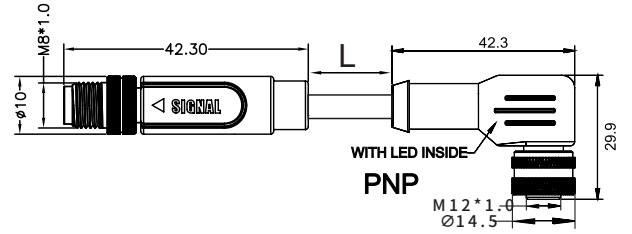

Contact layout/针孔排布(Front view/前视图)

3pins

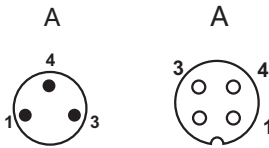

Circuit diagram/电路图

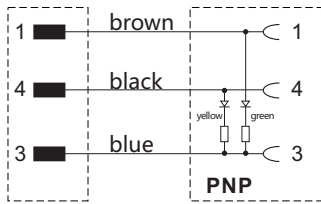

Order No/订货号

Cable length 线材长度	Contacts 芯数	0.25mm ²
0.3M	3pins	820103-56-780
0.6M	3pins	820103-56-781
1.0M	3pins	820103-56-782
2.0M	3pins	820103-56-783

Specification/技术参数

Number of contacts/芯数	3
Rated voltage/额定电压	50V AC / 60V DC
Rated current (40°C)/额定电流	3A
Protection degree/防护等级	IP67/IP68
Operating temperature/工作温度	-25°C ~ +80°C
Cable OD /线材直径	4.6mm

M8 Circular connectors

Y-type male cable

Product figure



Scale diagram

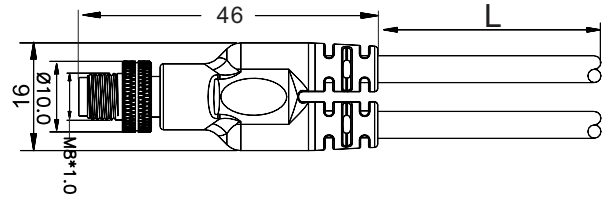

Contact layout/针孔排布(Front view/前视图)

4pins

A



Circuit diagram/电路图

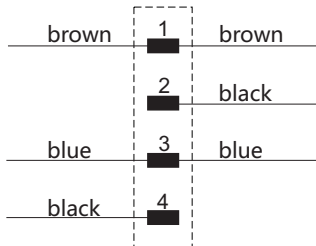

Order No/订货号

Cable length 线材长度	Contacts 芯数	0.25mm ²
1.5M	4pins	080104-30-691
3.0M	4pins	080104-30-692
5.0M	4pins	080104-30-693
7.5M	4pins	080104-30-694
10M	4pins	080104-30-695

Specification/技术参数

Number of contacts/芯数	4
Rated voltage/额定电压	50V AC / 60V DC
Rated current (40°C)/额定电流	3A
Protection degree/防护等级	IP67/IP68
Operating temperature/工作温度	-25°C ~ +80°C
Cable OD /线材直径	4.6~5.0mm

M8 Circular connectors

Y-type cable

Product figure(male to dual female M8-M8)

Scale diagram

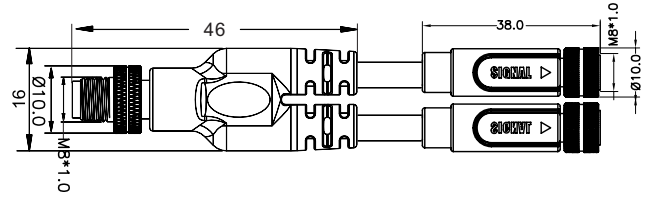

Contact layout/针孔排布(Front view/前视图)

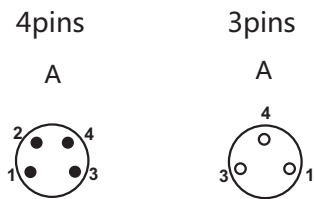

Circuit diagram/电路图

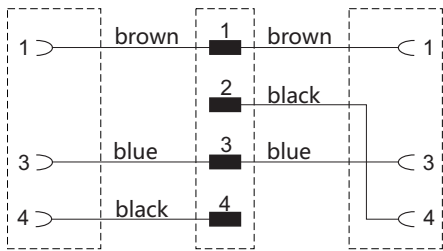

Order No/订货号

Cable length 线材长度	Contacts 芯数	Wire diameter 线径	PVC		PUR	
			black/黑色	gray/灰色	black/黑色	gray/灰色
0.3M	4-3pins	0.25mm ²	080104-30-601	080104-30-641	080104-30-621	080104-30-661
0.6M	4-3pins	0.25mm ²	080104-30-602	080104-30-642	080104-30-622	080104-30-662
1.0M	4-3pins	0.25mm ²	080104-30-603	080104-30-643	080104-30-623	080104-30-663
2.0M	4-3pins	0.25mm ²	080104-30-604	080104-30-644	080104-30-624	080104-30-664

Specification/技术参数

Number of contacts/芯数	4
Rated voltage/额定电压	50V AC / 60V DC
Rated current (40°C)/额定电流	3A
Protection degree/防护等级	IP67/IP68
Operating temperature/工作温度	-25°C ~ +80°C
Cable OD /线材直径	4.6~5.0mm

Male cable(with shield)

Product figure EtherCAT



Scale diagram

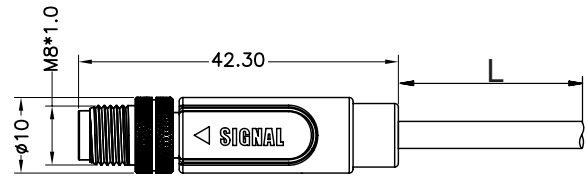

Contact layout/针孔排布(Front view/前视图)

4pins

A



Circuit diagram/电路图

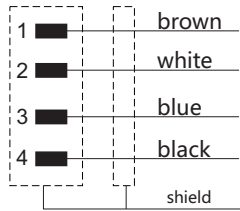

Order No/订货号

Cable length 线材长度	Contacts 芯数	Wire diameter 线径	PUR+AEB
			green/绿色
1.0M	4pins	0.15mm ²	080104-05-690
1.5M	4pins	0.15mm ²	080104-05-691
3.0M	4pins	0.15mm ²	080104-05-692
5.0M	4pins	0.15mm ²	080104-05-693
7.5M	4pins	0.15mm ²	080104-05-694
10M	4pins	0.15mm ²	080104-05-695

Specification/技术参数

Number of contacts/芯数	4
Rated voltage/额定电压	50V AC / 60V DC
Rated current (40°C)/额定电流	3A
Protection degree/防护等级	IP67/IP68
Operating temperature/工作温度	-25°C ~ +80°C
Cable OD /线材直径	4.6~5.0mm

M8 Circular connectors

Male cable(90° with shield)

Product figure EtherCAT



Scale diagram

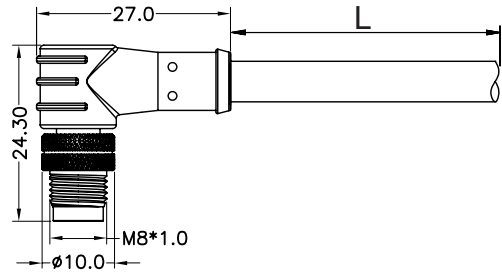

Contact layout/针孔排布(Front view/前视图)

4pins

A



Circuit diagram/电路图

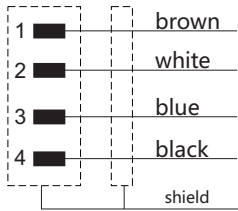

Order No/订货号

Cable length 线材长度	Contacts 芯数	Wire diameter 线径	PUR+AEB
			green/绿色
1.0M	4pins	0.15mm ²	080104-05-990
1.5M	4pins	0.15mm ²	080104-05-991
3.0M	4pins	0.15mm ²	080104-05-992
5.0M	4pins	0.15mm ²	080104-05-993
7.5M	4pins	0.15mm ²	080104-05-994
10M	4pins	0.15mm ²	080104-05-995

Specification/技术参数

Number of contacts/芯数	4
Rated voltage/额定电压	50V AC / 60V DC
Rated current (40°C)/额定电流	3A
Protection degree/防护等级	IP67/IP68
Operating temperature/工作温度	-25°C ~ +80°C
Cable OD /线材直径	4.6~5.0mm

M8 Circular connectors

Male to male cable(with shield)

Product figure EtherCAT



Scale diagram

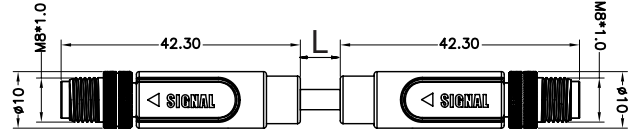

Contact layout/针孔排布(Front view/前视图)

4pins

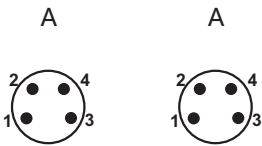

Circuit diagram/电路图

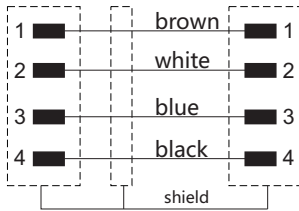

Order No/订货号

Cable length 线材长度	Contacts 芯数	Wire diameter 线径	PUR+AEB
			green/绿色
0.3M	4pins	0.15mm ²	080104-55-691
0.6M	4pins	0.15mm ²	080104-55-692
1.0M	4pins	0.15mm ²	080104-55-693
2.0M	4pins	0.15mm ²	080104-55-694

Specification/技术参数

Number of contacts/芯数	4
Rated voltage/额定电压	50V AC / 60V DC
Rated current (40°C)/额定电流	3A
Protection degree/防护等级	IP67/IP68
Operating temperature/工作温度	-25°C~+80°C
Cable OD /线材直径	4.6~5.0mm

M8 Circular connectors

R/A Male to R/A male cable(with shield)

Product figure EtherCAT



Scale diagram

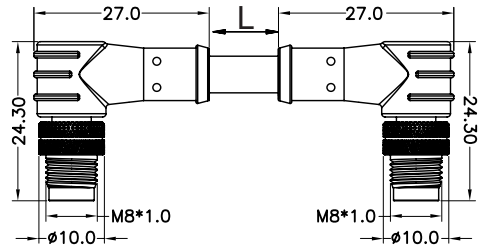

Contact layout/针孔排布(Front view/前视图)

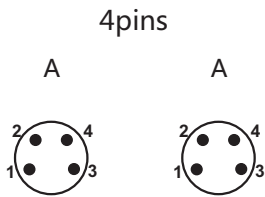

Circuit diagram/电路图

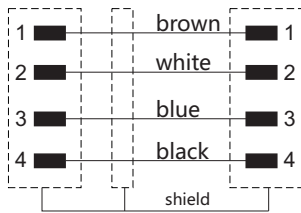

Order No/订货号

Cable length 线材长度	Contacts 芯数	Wire diameter 线径	PUR+AEB
			green/绿色
0.3M	4pins	0.15mm ²	080104-55-991
0.6M	4pins	0.15mm ²	080104-55-992
1.0M	4pins	0.15mm ²	080104-55-993
2.0M	4pins	0.15mm ²	080104-55-994

Specification/技术参数

Number of contacts/芯数	4
Rated voltage/额定电压	50V AC / 60V DC
Rated current (40°C)/额定电流	3A
Protection degree/防护等级	IP67/IP68
Operating temperature/工作温度	-25°C ~ +80°C
Cable OD /线材直径	4.6~5.0mm