

M12 Circular connectors

Male panel connector

Product figure (front fastened)



Scale diagram

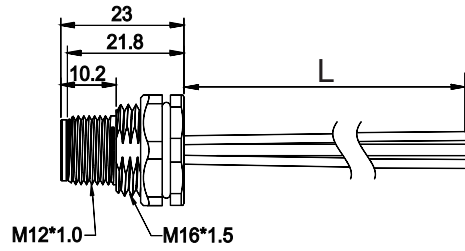

Contact layout/针孔排布 (Front view/前视图)

3pins

A



4pins

A



5pins

A



Circuit diagram/电路图

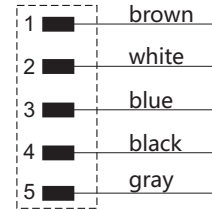
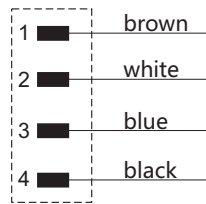
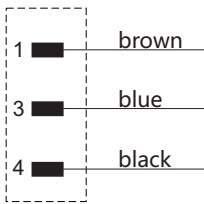

Order No/订货号

Cable length 线材长度	Contacts 芯数	Wire diameter 线径	PVC	TPE
0.1M	3pins	0.34mm ²	120103-03-911	120103-03-921
	4pins	0.34mm ²	120104-03-911	120104-03-921
	5pins	0.34mm ²	120105-03-911	120105-03-921
0.2M	3pins	0.34mm ²	120103-03-912	120103-03-922
	4pins	0.34mm ²	120104-03-912	120104-03-922
	5pins	0.34mm ²	120105-03-912	120105-03-922
0.5M	3pins	0.34mm ²	120103-03-913	120103-03-923
	4pins	0.34mm ²	120104-03-913	120104-03-923
	5pins	0.34mm ²	120105-03-913	120105-03-923
1.0M	3pins	0.34mm ²	120103-03-914	120103-03-924
	4pins	0.34mm ²	120104-03-914	120104-03-924
	5pins	0.34mm ²	120105-03-914	120105-03-924

Specifications/技术参数

Number of contacts/芯数	3	4	5
Rated voltage/额定电压	250V		60V
Rated current (40°C)/额定电流	4A		
Protection degree/防护等级	IP67/IP68		
Operating temperature/工作温度	-25°C ~ +80°C		

Male panel connector

Product figure (front fastened)



Scale diagram

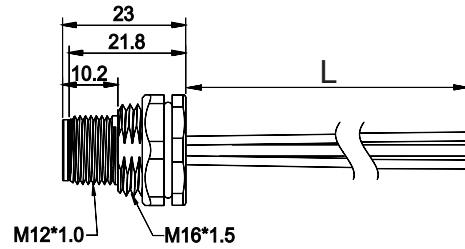

Contact layout/针孔排布 (Front view/前视图)

8pins

A

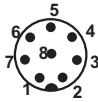

12pins

A

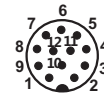

Circuit diagram/电路图

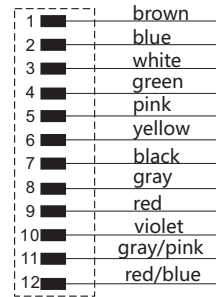
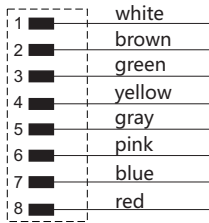

Order No/订货号

Cable length 线材长度	Contacts 芯数	Wire diameter 线径	PVC	TPE
0.1M	8pins	0.25mm ²	120108-03-911	120108-03-921
	12pins	0.25mm ²	120112-03-911	120112-03-921
0.2M	8pins	0.25mm ²	120108-03-912	120108-03-922
	12pins	0.25mm ²	120112-03-912	120112-03-922
0.5M	8pins	0.25mm ²	120108-03-913	120108-03-923
	12pins	0.25mm ²	120112-03-913	120112-03-923
1.0M	8pins	0.25mm ²	120108-03-914	120108-03-924
	12pins	0.25mm ²	120112-03-914	120112-03-924

Specifications/技术参数

Number of contacts/芯数	8	12
Rated voltage/额定电压	30V	
Rated current (40°C)/额定电流	2A	1.5A
Protection degree/防护等级	IP67/IP68	
Operating temperature/工作温度	-25°C ~ +80°C	

M12 Circular connectors

Female panel connector

Product figure (front fastened)



Scale diagram

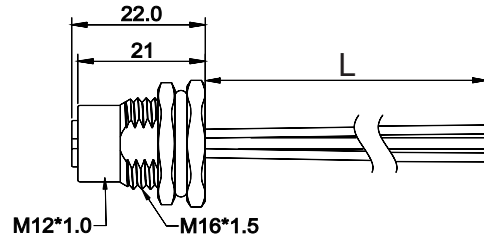

Contact layout/针孔排布 (Front view/前视图)

3pins

A



4pins

A



5pins

A



Circuit diagram/电路图

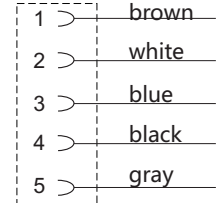
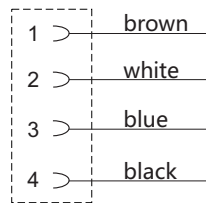
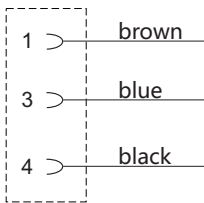

Order No/订货号

Cable length 线材长度	Contacts 芯数	Wire diameter 线径	PVC	TPE
0.1M	3pins	0.34mm ²	120103-04-911	120103-04-921
	4pins	0.34mm ²	120104-04-911	120104-04-921
	5pins	0.34mm ²	120105-04-911	120105-04-921
0.2M	3pins	0.34mm ²	120103-04-912	120103-04-922
	4pins	0.34mm ²	120104-04-912	120104-04-922
	5pins	0.34mm ²	120105-04-912	120105-04-922
0.5M	3pins	0.34mm ²	120103-04-913	120103-04-923
	4pins	0.34mm ²	120104-04-913	120104-04-923
	5pins	0.34mm ²	120105-04-913	120105-04-923
1.0M	3pins	0.34mm ²	120103-04-914	120103-04-924
	4pins	0.34mm ²	120104-04-914	120104-04-924
	5pins	0.34mm ²	120105-04-914	120105-04-924

Specifications/技术参数

Number of contacts/芯数	3	4	5
Rated voltage/额定电压	250V		60V
Rated current (40°C)/额定电流	4A		
Protection degree/防护等级	IP67/IP68		
Operating temperature/工作温度	-25°C ~ +80°C		

Female panel connector

Product figure (front fastened)



Scale diagram

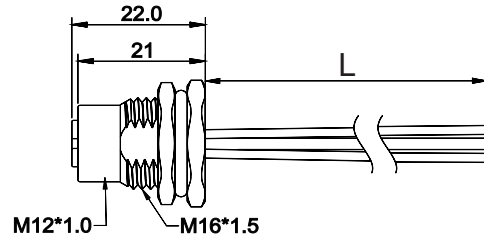

Contact layout/针孔排布 (Front view/前视图)

8pins

A

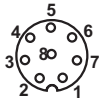

12pins

A

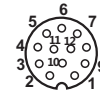

Circuit diagram/电路图

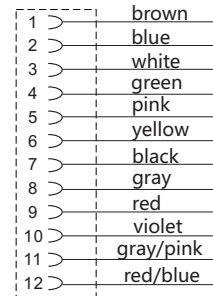
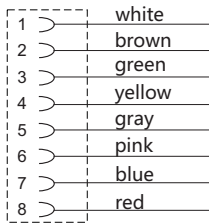

Order No/订货号

Cable length 线材长度	Contacts 芯数	Wire diameter 线径	PVC	TPE
0.1M	8pins	0.25mm ²	120108-04-911	120108-04-921
	12pins	0.25mm ²	120112-04-911	120112-04-921
0.2M	8pins	0.25mm ²	120108-04-912	120108-04-922
	12pins	0.25mm ²	120112-04-912	120112-04-922
0.5M	8pins	0.25mm ²	120108-04-913	120108-04-923
	12pins	0.25mm ²	120112-04-913	120112-04-923
1.0M	8pins	0.25mm ²	120108-04-914	120108-04-924
	12pins	0.25mm ²	120112-04-914	120112-04-924

Specifications/技术参数

Number of contacts/芯数	8	12
Rated voltage/额定电压	30V	
Rated current (40°C)/额定电流	2A	1.5A
Protection degree/防护等级	IP67/IP68	
Operating temperature/工作温度	-25°C ~ +80°C	

M12 Circular connectors

Male panel connector

Product figure (rear fastened)



Scale diagram

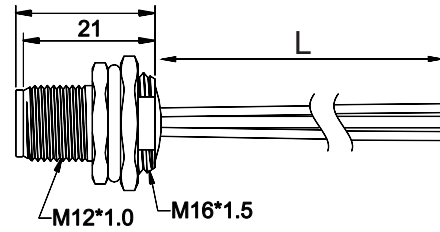

Contact layout/针孔排布 (Front view/前视图)

3pins

A



4pins

A



5pins

A



Circuit diagram/电路图

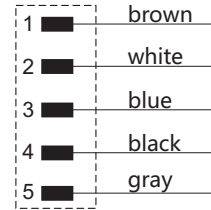
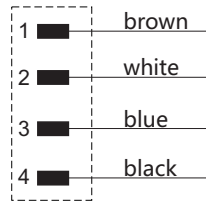
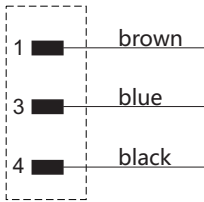

Order No/订货号

Cable length 线材长度	Contacts 芯数	Wire diameter 线径	Material	
			PVC	TPE
0.1M	3pins	0.34mm ²	120103-03-811	120103-03-821
	4pins	0.34mm ²	120104-03-811	120104-03-821
	5pins	0.34mm ²	120105-03-811	120105-03-821
0.2M	3pins	0.34mm ²	120103-03-812	120103-03-822
	4pins	0.34mm ²	120104-03-812	120104-03-822
	5pins	0.34mm ²	120105-03-812	120105-03-822
0.5M	3pins	0.34mm ²	120103-03-813	120103-03-823
	4pins	0.34mm ²	120104-03-813	120104-03-823
	5pins	0.34mm ²	120105-03-813	120105-03-823
1.0M	3pins	0.34mm ²	120103-03-814	120103-03-824
	4pins	0.34mm ²	120104-03-814	120104-03-824
	5pins	0.34mm ²	120105-03-814	120105-03-824

Specifications/技术参数

Number of contacts/芯数	3	4	5
Rated voltage/额定电压	250V		60V
Rated current (40°C)/额定电流	4A		
Protection degree/防护等级	IP67/IP68		
Operating temperature/工作温度	-25°C ~ +80°C		

Male panel connector

Product figure (rear fastened)



Scale diagram

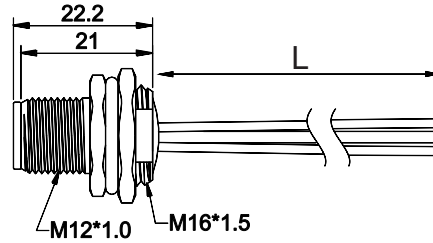

Contact layout/针孔排布 (Front view/前视图)

8pins

A

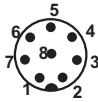

12pins

A

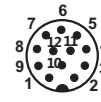

Circuit diagram/电路图

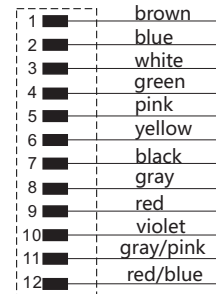
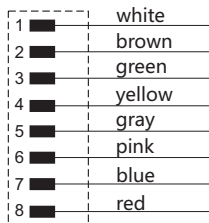

Order No/订货号

Cable length 线材长度	Contacts 芯数	Wire diameter 线径	PVC	TPE
0.1M	8pins	0.25mm ²	120108-03-811	120108-03-821
	12pins	0.25mm ²	120112-03-811	120112-03-821
0.2M	8pins	0.25mm ²	120108-03-812	120108-03-822
	12pins	0.25mm ²	120112-03-812	120112-03-822
0.5M	8pins	0.25mm ²	120108-03-813	120108-03-823
	12pins	0.25mm ²	120112-03-813	120112-03-823
1.0M	8pins	0.25mm ²	120108-03-814	120108-03-824
	12pins	0.25mm ²	120112-03-814	120112-03-824

Specifications/技术参数

Number of contacts/芯数	8	12
Rated voltage/额定电压	30V	
Rated current (40°C)/额定电流	2A	1.5A
Protection degree/防护等级	IP67/IP68	
Operating temperature/工作温度	-25°C ~ +80°C	

M12 Circular connectors

Female panel connector

Product figure (rear fastened)



Scale diagram

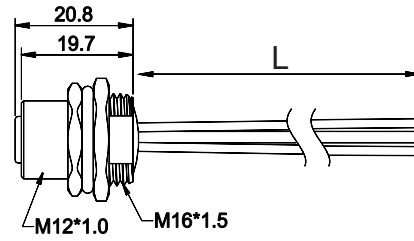

Contact layout/针孔排布 (Front view/前视图)

3pins

A



4pins

A



5pins

A



Circuit diagram/电路图

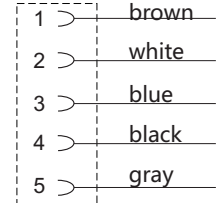
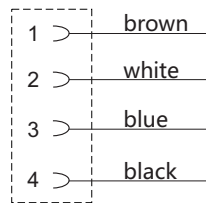
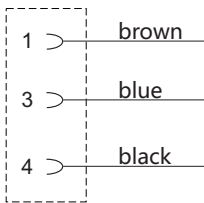

Order No/订货号

Cable length 线材长度	Contacts 芯数	Wire diameter 线径	PVC	TPE
0.1M	3pins	0.34mm ²	120103-04-811	120103-04-821
	4pins	0.34mm ²	120104-04-811	120104-04-821
	5pins	0.34mm ²	120105-04-811	120105-04-821
0.2M	3pins	0.34mm ²	120103-04-812	120103-04-822
	4pins	0.34mm ²	120104-04-812	120104-04-822
	5pins	0.34mm ²	120105-04-812	120105-04-822
0.5M	3pins	0.34mm ²	120103-04-813	120103-04-823
	4pins	0.34mm ²	120104-04-813	120104-04-823
	5pins	0.34mm ²	120105-04-813	120105-04-823
1.0M	3pins	0.34mm ²	120103-04-814	120103-04-824
	4pins	0.34mm ²	120104-04-814	120104-04-824
	5pins	0.34mm ²	120105-04-814	120105-04-824

Specifications/技术参数

Number of contacts/芯数	3	4	5
Rated voltage/额定电压	250V		60V
Rated current (40°C)/额定电流	4A		
Protection degree/防护等级	IP67/IP68		
Operating temperature/工作温度	-25°C ~ +80°C		

Female panel connector

Product figure (rear fastened)



Scale diagram

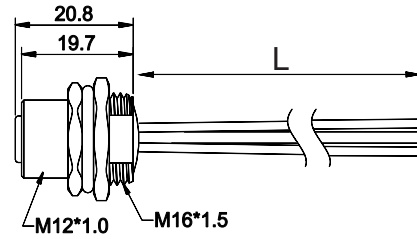

Contact layout/针孔排布 (Front view/前视图)

8pins

A

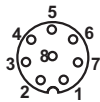

12pins

A

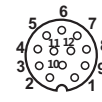

Circuit diagram/电路图

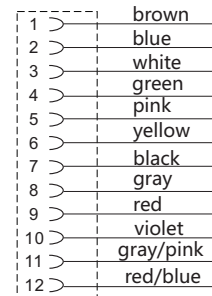
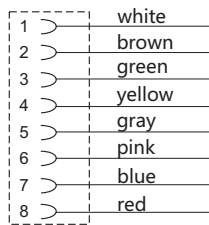

Order No/订货号

Cable length 线材长度	Contacts 芯数	Wire diameter 线径	PVC	TPE
0.1M	8pins	0.25mm ²	120108-04-811	120108-04-821
	12pins	0.25mm ²	120112-04-811	120112-04-821
0.2M	8pins	0.25mm ²	120108-04-812	120108-04-822
	12pins	0.25mm ²	120112-04-812	120112-04-822
0.5M	8pins	0.25mm ²	120108-04-813	120108-04-823
	12pins	0.25mm ²	120112-04-813	120112-04-923
1.0M	8pins	0.25mm ²	120108-04-814	120108-04-824
	12pins	0.25mm ²	120112-04-814	120112-04-824

Specifications/技术参数

Number of contacts/芯数	8	12
Rated voltage/额定电压	30V	
Rated current (40°C)/额定电流	2A	1.5A
Protection degree/防护等级	IP67/IP68	
Operating temperature/工作温度	-25°C ~ +80°C	

M12 Circular connectors

Male panel connector (A/B-coded)

Product figure (rear fastened) DeviceNet, CANopen

Scale diagram

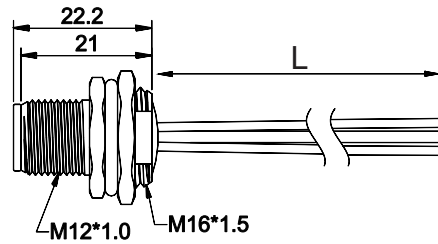

Contact layout/针孔排布 (Front view/前视图)

5pins

A



5pins

B



Circuit diagram/电路图

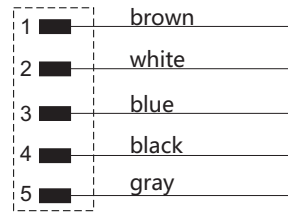
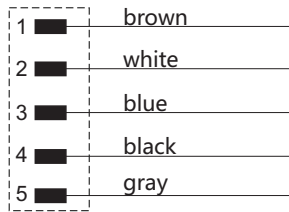

Order No/订货号

Cable length 线材长度	Coding	Contacts 芯数	Wire diameter 线径	PVC	TPE
0.1M	A	5pins	0.34mm ²	120105-03-831	120105-03-841
	B	5pins	0.34mm ²	120205-03-831	120205-03-841
0.2M	A	5pins	0.34mm ²	120105-03-832	120105-03-842
	B	5pins	0.34mm ²	120205-03-832	120205-03-842
0.5M	A	5pins	0.34mm ²	120105-03-833	120105-03-843
	B	5pins	0.34mm ²	120205-03-833	120205-03-843
1.0M	A	5pins	0.34mm ²	120105-03-834	120105-03-844
	B	5pins	0.34mm ²	120205-03-834	120205-03-844

Specifications/技术参数

Number of contacts/芯数	5
Rated voltage/额定电压	60V
Rated current (40°C)/额定电流	4A
Protection degree/防护等级	IP67/IP68
Operating temperature/工作温度	-25°C ~ +80°C

Female panel connector (A/B-coded)

Product figure (rear fastened) DeviceNet, CANopen



Scale diagram

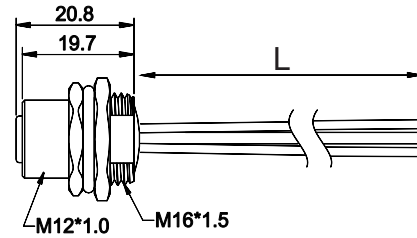

Contact layout/针孔排布 (Front view/前视图)

5pins

A



5pins

B



Circuit diagram/电路图

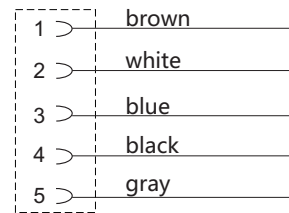
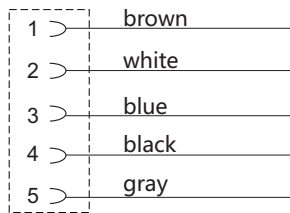

Order No/订货号

Cable length 线材长度	Coding	Contacts 芯数	Wire diameter 线径	PVC	TPE
0.1M	A	5pins	0.34mm ²	120105-04-831	120105-04-841
	B	5pins	0.34mm ²	120205-04-831	120205-04-841
0.2M	A	5pins	0.34mm ²	120105-04-832	120105-04-842
	B	5pins	0.34mm ²	120205-04-832	120205-04-842
0.5M	A	5pins	0.34mm ²	120105-04-833	120105-04-843
	B	5pins	0.34mm ²	120205-04-833	120205-04-843
1.0M	A	5pins	0.34mm ²	120105-04-834	120105-04-844
	B	5pins	0.34mm ²	120205-04-834	120205-04-844

Specifications/技术参数

Number of contacts/芯数	5
Rated voltage/额定电压	60V
Rated current (40°C)/额定电流	4A
Protection degree/防护等级	IP67/IP68
Operating temperature/工作温度	-25°C ~ +80°C

M12 Circular connectors

Female panel connector (D-coded)

Product figure (rear fastened) ETHERNET CAT5



Scale diagram

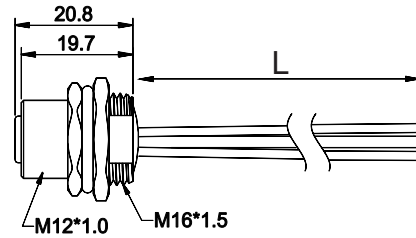

Contact layout/针孔排布 (Front view/前视图)

4pins

D



Circuit diagram/电路图

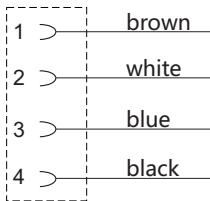

Order No/订货号

Cable length 线材长度	Contacts 芯数	Wire diameter 线径	PVC	TPE
0.1M	4pins	0.34mm ²	120404-04-831	120404-04-841
0.2M	4pins	0.34mm ²	120404-04-832	120404-04-842
0.5M	4pins	0.34mm ²	120404-04-833	120404-04-843
1.0M	4pins	0.34mm ²	120404-04-834	120404-04-844

Specifications/技术参数

Number of contacts/芯数	4
Rated voltage/额定电压	250V
Rated current (40°C)/额定电流	4A
Protection degree/防护等级	IP67/IP68
Operating temperature/工作温度	-25°C ~ +80°C

M12 Circular connectors

Male panel connector

Product figure (front fastened)



Scale diagram

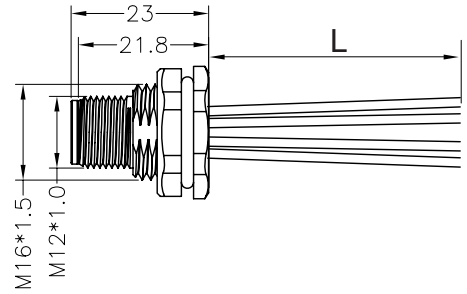

Contact layout/针孔排布 (Front view/前视图)

4+FE

E



Order Data/订货信息

Contacts/芯数	Coding	Order No/订货号	P/N/料号
4+FE	E	121105-03-001	—

Specifications/技术参数

Number of contacts/芯数	4+FE
Termination/接线方式	solder/焊线式
Wire gauge/线规	max. 1.5mm ² (max.16 AWG)
Operating temperature/工作温度	-40°C~+80°C
Mechanical operation/插拔次数	> 100 mating cycles
Rated voltage/额定电压	63V
Rated current (40°C)/额定电流	16A
Protection degree/防护等级	IP67/IP68
Contact resistance/接触电阻	≤3mΩ
Insulation resistance/绝缘电阻	≥100MΩ
Pin contact/插针材料	CuZn
Socket contact/插孔材料	CuSn
Contact plating/针孔镀层材料	Au

Female panel connector

Product figure (front fastened)



Scale diagram

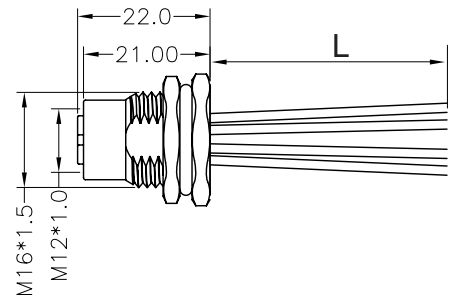

Contact layout/针孔排布 (Front view/前视图)

4+FE

E



Order Data/订货信息

Contacts/芯数	Coding	Order No/订货号	P/N/料号
4+FE	E	121105-04-001	—

Specifications/技术参数

Number of contacts/芯数	4+FE
Termination/接线方式	solder/焊线式
Wire gauge/线规	max. 1.5mm ² (max.16 AWG)
Operating temperature/工作温度	-40°C~+80°C
Mechanical operation/插拔次数	> 100 mating cycles
Rated voltage/额定电压	63V
Rated current (40°C)/额定电流	16A
Protection degree/防护等级	IP67/IP68
Contact resistance/接触电阻	≤3mΩ
Insulation resistance/绝缘电阻	≥100MΩ
Pin contact/插针材料	CuZn
Socket contact/插孔材料	CuSn
Contact plating/针孔镀层材料	Au

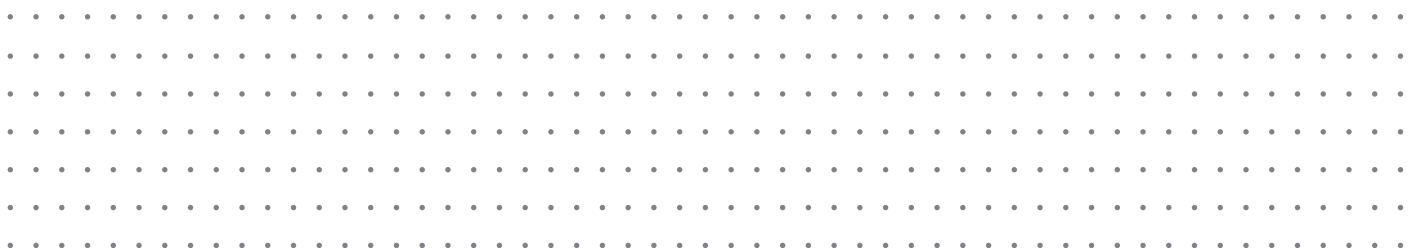

M12 Circular connectors

Male panel connector

Product figure (front fastened)



Scale diagram

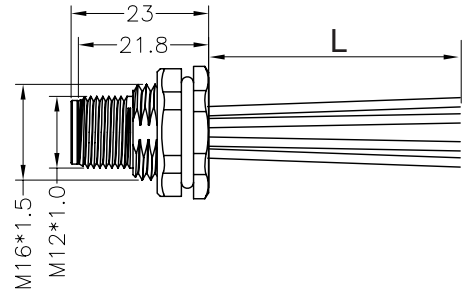

Contact layout/针孔排布 (Front view/前视图)

4pins

F



Order Data/订货信息

Contacts/芯数	Coding	Order No/订货号	P/N/料号
4pins	F	121204-03-001	—

Specifications/技术参数

Number of contacts/芯数	4
Termination/接线方式	solder/焊线式
Wire gauge/线规	max. 1.5mm ² (max.16 AWG)
Operating temperature/工作温度	-40°C ~ +80°C
Mechanical operation/插拔次数	> 100 mating cycles
Rated voltage/额定电压	63V
Rated current (40°C)/额定电流	16A
Protection degree/防护等级	IP67/IP68
Contact resistance/接触电阻	≤3mΩ
Insulation resistance/绝缘电阻	≥100MΩ
Pin contact/插针材料	CuZn
Socket contact/插孔材料	CuSn
Contact plating/针孔镀层材料	Au

Female panel connector

Product figure (front fastened)



Scale diagram

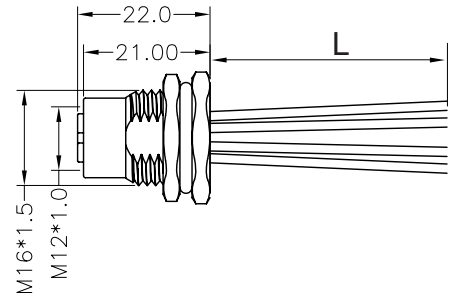

Contact layout/针孔排布 (Front view/前视图)

4pins

F



Order Data/订货信息

Contacts/芯数	Coding	Order No/订货号	P/N/料号
4pins	F	121204-04-001	—

Specifications/技术参数

Number of contacts/芯数	4
Termination/接线方式	solder/焊线式
Wire gauge/线规	max. 1.5mm ² (max.16 AWG)
Operating temperature/工作温度	-40°C~+80°C
Mechanical operation/插拔次数	> 100 mating cycles
Rated voltage/额定电压	63V
Rated current (40°C)/额定电流	16A
Protection degree/防护等级	IP67/IP68
Contact resistance/接触电阻	≤3mΩ
Insulation resistance/绝缘电阻	≥100MΩ
Pin contact/插针材料	CuZn
Socket contact/插孔材料	CuSn
Contact plating/针孔镀层材料	Au

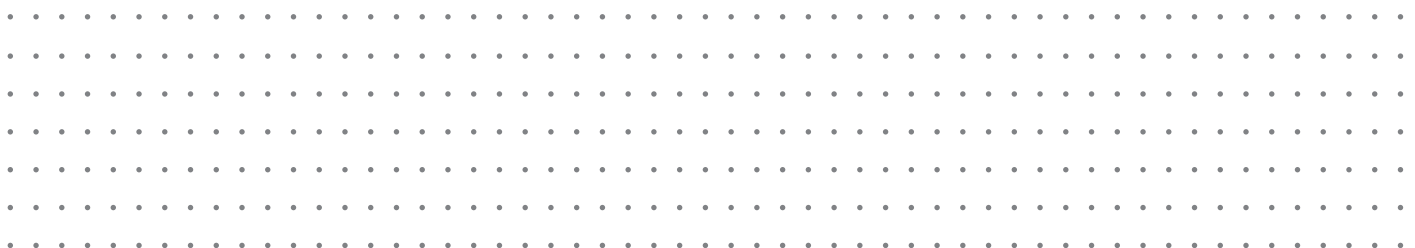

M12 Circular connectors

Male panel connector

Product figure (front fastened)



Scale diagram

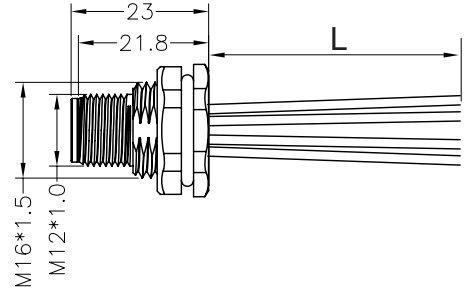

Contact layout/针孔排布 (Front view/前视图)

4+PE

K



Order Data/订货信息

Contacts/芯数	Coding	Order No/订货号	P/N/料号
4+PE	K	121305-03-001	—

Specifications/技术参数

Number of contacts/芯数	4+PE
Termination/接线方式	solder/焊接
Wire gauge/线规	max. 1.5mm ² (max.16 AWG)
Operating temperature/工作温度	-40°C~+85°C
Mechanical operation/插拔次数	> 100 mating cycles
Rated voltage/额定电压	630V
Rated current (40°C)/额定电流	12A
Protection degree/防护等级	IP67/IP68
Contact resistance/接触电阻	≤3mΩ
Insulation resistance/绝缘电阻	≥100MΩ
Pin contact/插针材料	CuZn
Socket contact/插孔材料	CuSn
Contact plating/针孔镀层材料	Au

Female panel connector

Product figure (front fastened)



Scale diagram

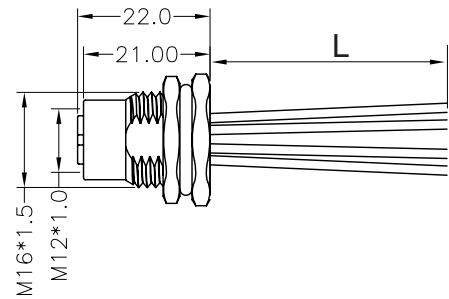

Contact layout/针孔排布 (Front view/前视图)

4+PE

K



Order Data/订货信息

Contacts/芯数	Coding	Order No./订货号	P/N/料号
4+PE	K	121305-04-001	—

Specifications/技术参数

Number of contacts/芯数	4+PE
Termination/接线方式	solder/焊接
Wire gauge/线规	max. 1.5mm ² (max.16 AWG)
Operating temperature/工作温度	-40°C~+85°C
Mechanical operation/插拔次数	> 100 mating cycles
Rated voltage/额定电压	630V
Rated current (40°C)/额定电流	12A
Protection degree/防护等级	IP67/IP68
Contact resistance/接触电阻	≤3mΩ
Insulation resistance/绝缘电阻	≥100MΩ
Pin contact/插针材料	CuZn
Socket contact/插孔材料	CuSn
Contact plating/针孔镀层材料	Au



M12 Circular connectors

Male panel connector

Product figure (front fastened)



Scale diagram

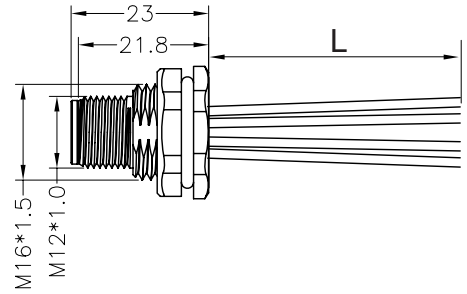

Contact layout/针孔排布 (Front view/前视图)

4+FE

L



Order Data/订货信息

Contacts/芯数	Coding	Order No/订货号	P/N/料号
4+FE	L	121005-03-005	PMM12FLM05001

Specifications/技术参数

Number of contacts/芯数	4+FE
Termination/接线方式	solder/焊线式
Wire gauge/线规	max. 1.5mm ² (max.16 AWG)
Operating temperature/工作温度	-40°C~+80°C
Mechanical operation/插拔次数	> 100 mating cycles
Rated voltage/额定电压	63V
Rated current (40°C)/额定电流	16A
Protection degree/防护等级	IP67/IP68
Contact resistance/接触电阻	≤3mΩ
Insulation resistance/绝缘电阻	≥100MΩ
Pin contact/插针材料	CuZn
Socket contact/插孔材料	CuSn
Contact plating/针孔镀层材料	Au

Female panel connector

Product figure (front fastened)



Scale diagram

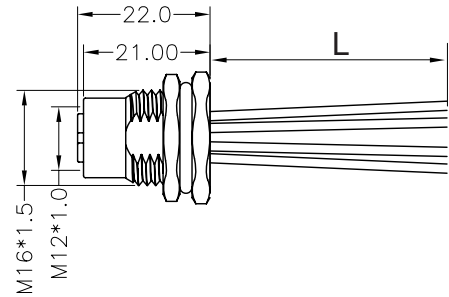

Contact layout/针孔排布 (Front view/前视图)

4+FE

L



Order Data/订货信息

Contacts/芯数	Coding	Order No/订货号	P/N/料号
4+FE	L	121005-04-001	PMM12FLF05001

Specifications/技术参数

Number of contacts/芯数	4+FE
Termination/接线方式	solder/焊线式
Wire gauge/线规	max. 1.5mm ² (max.16 AWG)
Operating temperature/工作温度	-40°C~+80°C
Mechanical operation/插拔次数	> 100 mating cycles
Rated voltage/额定电压	63V
Rated current (40°C)/额定电流	16A
Protection degree/防护等级	IP67/IP68
Contact resistance/接触电阻	≤3mΩ
Insulation resistance/绝缘电阻	≥100MΩ
Pin contact/插针材料	CuZn
Socket contact/插孔材料	CuSn
Contact plating/针孔镀层材料	Au

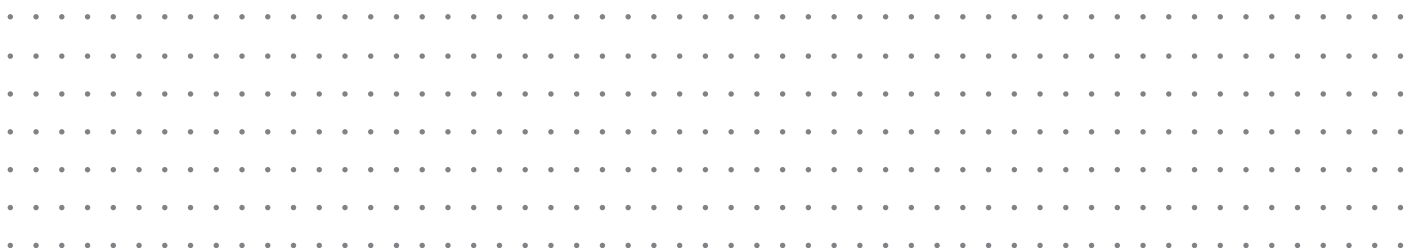

M12 Circular connectors

Male panel connector

Product figure (front fastened)



Scale diagram

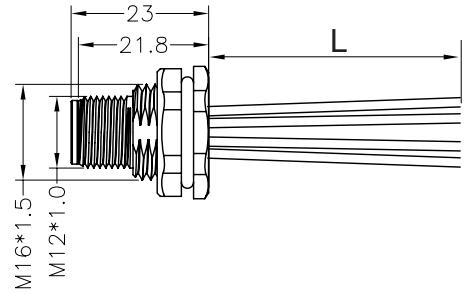

Contact layout/针孔排布 (Front view/前视图)

5+PE

M



Order Data/订货信息

Contacts/芯数	Coding	Order No/订货号	P/N/料号
5+PE	M	121406-03-001	—

Specifications/技术参数

Number of contacts/芯数	5+PE
Termination/接线方式	solder/焊接
Wire gauge/线规	max. 1.5mm ² (max.16 AWG)
Operating temperature/工作温度	-40°C~+80°C
Mechanical operation/插拔次数	> 100 mating cycles
Rated voltage/额定电压	630V
Rated current (40°C)/额定电流	8A
Protection degree/防护等级	IP67/IP68
Contact resistance/接触电阻	≤3mΩ
Insulation resistance/绝缘电阻	≥100MΩ
Pin contact/插针材料	CuZn
Socket contact/插孔材料	CuSn
Contact plating/针孔镀层材料	Au

Female panel connector

Product figure (front fastened)



Scale diagram

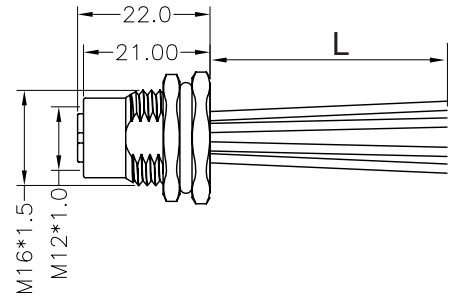

Contact layout/针孔排布 (Front view/前视图)

5+PE

M



Order Data/订货信息

Contacts/芯数	Coding	Order No./订货号	P/N/料号
5+PE	M	121406-04-001	—

Specifications/技术参数

Number of contacts/芯数	5+PE
Termination/接线方式	solder/焊接
Wire gauge/线规	max. 1.5mm ² (max.16 AWG)
Operating temperature/工作温度	-40°C~+80°C
Mechanical operation/插拔次数	> 100 mating cycles
Rated voltage/额定电压	630V
Rated current (40°C)/额定电流	8A
Protection degree/防护等级	IP67/IP68
Contact resistance/接触电阻	≤3mΩ
Insulation resistance/绝缘电阻	≥100MΩ
Pin contact/插针材料	CuZn
Socket contact/插孔材料	CuSn
Contact plating/针孔镀层材料	Au

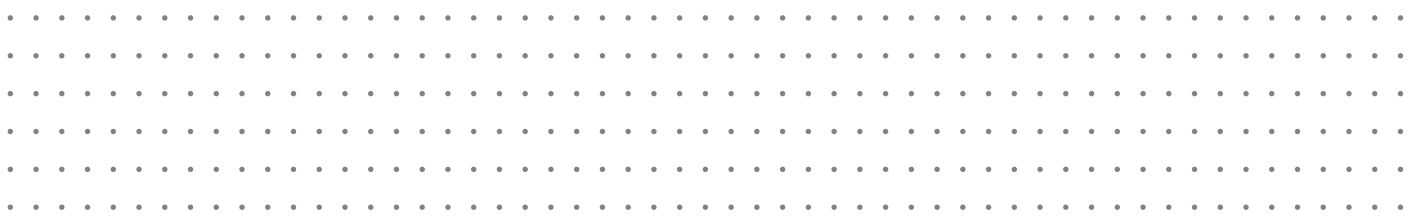

M12 Circular connectors

Male panel connector

Product figure (rear fastened)



Scale diagram

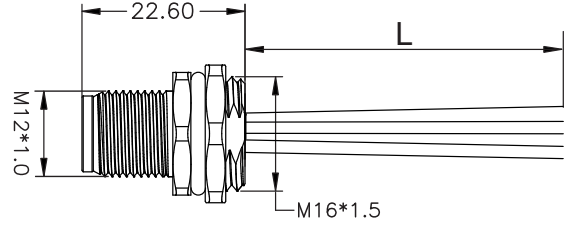

Contact layout/针孔排布 (Front view/前视图)

2+PE

S



3+PE

S



Order Data/订货信息

Contacts/芯数	Coding	Order No/订货号	P/N/料号
2+PE	S	120503-03-001	PMM12BSM03001
3+PE	S	120504-03-001	PMM12BSM04001

Specifications/技术参数

Number of contacts/芯数	2+PE	3+PE
Termination/接线方式	solder/焊线式	
Wire gauge/线规	max. 1.5mm ² (max.16 AWG)	
Operating temperature/工作温度	-40°C ~ +80°C	
Mechanical operation/插拔次数	> 100 mating cycles	
Rated voltage/额定电压	630V	
Rated current (40°C)/额定电流	12A	
Protection degree/防护等级	IP67/IP68	
Contact resistance/接触电阻	≤3mΩ	
Insulation resistance/绝缘电阻	≥100MΩ	
Pin contact/插针材料	CuZn	
Socket contact/插孔材料	CuSn	
Contact plating/针孔镀层材料	Au	

Female panel connector

Product figure (rear fastened)



Scale diagram

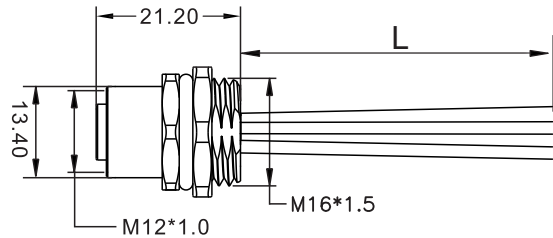

Contact layout/针孔排布 (Front view/前视图)

2+PE

S



3+PE

S



Order Data/订货信息

Contacts/芯数	Coding	Order No/订货号	P/N/料号
2+PE	S	120503-04-001	PMM12BSF03001
3+PE	S	120504-04-002	PMM12BSF04001

Specifications/技术参数

Number of contacts/芯数	2+PE	3+PE
Termination/接线方式	solder/焊线式	
Wire gauge/线规	max. 1.5mm ² (max.16 AWG)	
Operating temperature/工作温度	-40°C ~ +80°C	
Mechanical operation/插拔次数	> 100 mating cycles	
Rated voltage/额定电压	630V	
Rated current (40°C)/额定电流	12A	
Protection degree/防护等级	IP67/IP68	
Contact resistance/接触电阻	≤3mΩ	
Insulation resistance/绝缘电阻	≥100MΩ	
Pin contact/插针材料	CuZn	
Socket contact/插孔材料	CuSn	
Contact plating/针孔镀层材料	Au	



M12 Circular connectors

Male panel connector (S-coded)

Product figure (rear fastened)



Scale diagram

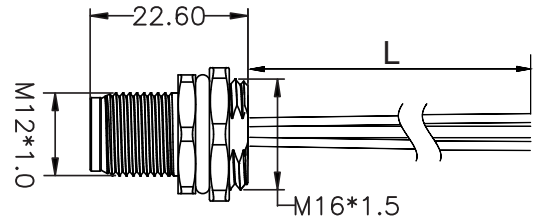

Contact layout/针孔排布 (Front view/前视图)

3pins

S



4pins

S



Circuit diagram/电路图



Order No/订货号

Cable length 线材长度	Contacts 芯数	Wire diameter 线径	PVC	TPE
0.1M	3pins	1.5mm ²	120503-03-811	120503-03-821
	4pins	1.5mm ²	120504-03-811	120504-03-821
0.2M	3pins	1.5mm ²	120503-03-812	120503-03-822
	4pins	1.5mm ²	120504-03-812	120504-03-822
0.5M	3pins	1.5mm ²	120503-03-813	120503-03-823
	4pins	1.5mm ²	120504-03-813	120504-03-823
1.0M	3pins	1.5mm ²	120503-03-814	120503-03-824
	4pins	1.5mm ²	120504-03-814	120504-03-824

Specifications/技术参数

Number of contacts/芯数	3	4
Rated voltage/额定电压	630V	
Rated current (40°C)/额定电流	16A	12A
Protection degree/防护等级	IP67/IP68	
Operating temperature/工作温度	-25°C ~ +80°C	

Female panel connector (S-coded)

Product figure (rear fastened)



Scale diagram

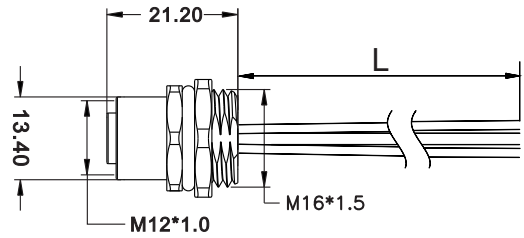

Contact layout/针孔排布 (Front view/前视图)

3pins

S



4pins

S



Circuit diagram/电路图

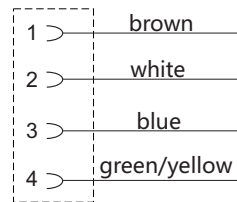
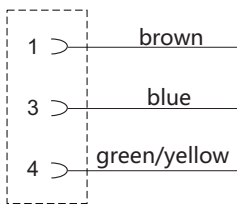

Order No/订货号

Cable length 线材长度	Contacts 芯数	Wire diameter 线径	PVC	TPE
0.1M	3pins	1.5mm ²	120503-04-811	120503-04-821
	4pins	1.5mm ²	120504-04-811	120504-04-821
0.2M	3pins	1.5mm ²	120503-04-812	120503-04-822
	4pins	1.5mm ²	120504-04-812	120504-04-822
0.5M	3pins	1.5mm ²	120503-04-813	120503-04-823
	4pins	1.5mm ²	120504-04-813	120504-04-823
1.0M	3pins	1.5mm ²	120503-04-814	120503-04-824
	4pins	1.5mm ²	120504-04-814	120504-04-824

Specifications/技术参数

Number of contacts/芯数	3	4
Rated voltage/额定电压	630V	
Rated current (40°C)/额定电流	16A	12A
Protection degree/防护等级	IP67/IP68	
Operating temperature/工作温度	-25°C ~ +80°C	

M12 Circular connectors

Male panel connector (T-coded)

Product figure (rear fastened)



Scale diagram

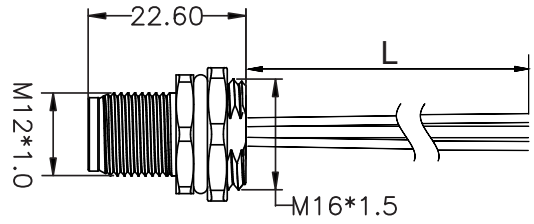

Contact layout/针孔排布 (Front view/前视图)

4pins

T



Circuit diagram/电路图

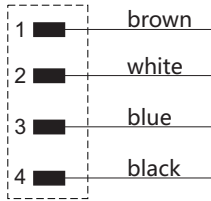

Order No/订货号

Cable length 线材长度	Contacts 芯数	Wire diameter 线径	PVC	TPE
0.1M	4pins	1.5mm ²	120604-03-811	120604-03-821
0.2M	4pins	1.5mm ²	120604-03-812	120604-03-822
0.5M	4pins	1.5mm ²	120604-03-813	120604-03-823
1.0M	4pins	1.5mm ²	120604-03-814	120604-03-824

Specifications/技术参数

Number of contacts/芯数	4
Rated voltage/额定电压	63V
Rated current (40°C)/额定电流	12A
Protection degree/防护等级	IP67/IP68
Operating temperature/工作温度	-25°C ~ +80°C

M12 Circular connectors

Female panel connector (T-coded)

Product figure (rear fastened)



Scale diagram

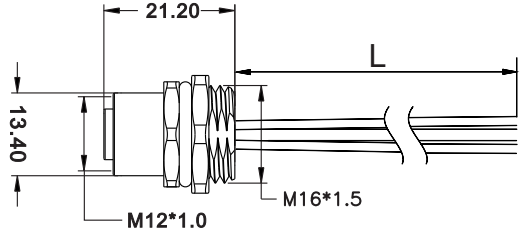

Contact layout/针孔排布 (Front view/前视图)

4pins

T



Circuit diagram/电路图

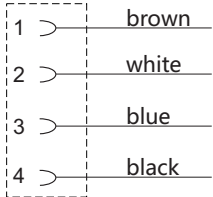

Order No/订货号

Cable length 线材长度	Contacts 芯数	Wire diameter 线径	PVC	TPE
0.1M	4pins	1.5mm ²	120604-04-811	120604-04-821
0.2M	4pins	1.5mm ²	120604-04-812	120604-04-822
0.5M	4pins	1.5mm ²	120604-04-813	120604-04-823
1.0M	4pins	1.5mm ²	120604-04-814	120604-04-824

Specifications/技术参数

Number of contacts/芯数	4
Rated voltage/额定电压	63V
Rated current (40°C)/额定电流	12A
Protection degree/防护等级	IP67/IP68
Operating temperature/工作温度	-25°C ~ +80°C

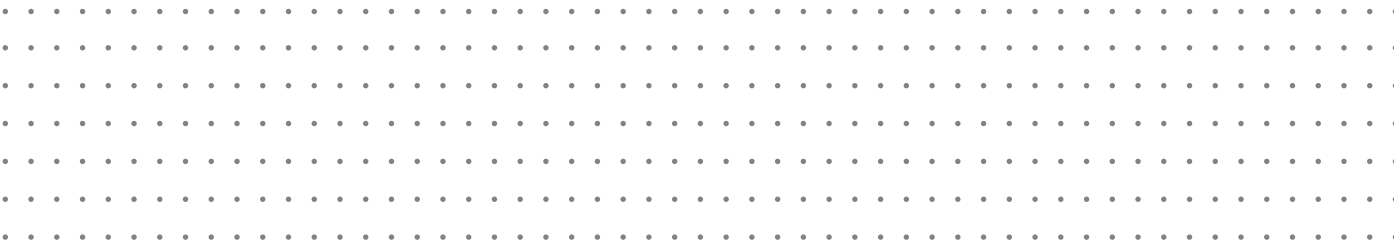

Female panel connector (X-coded)

Product figure (rear fastened) ETHERNET CAT6



Scale diagram

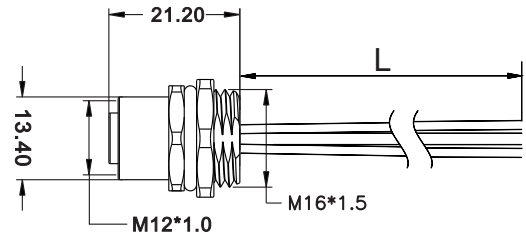

Contact layout/针孔排布 (Front view/前视图)

8pins

X



Circuit diagram/电路图

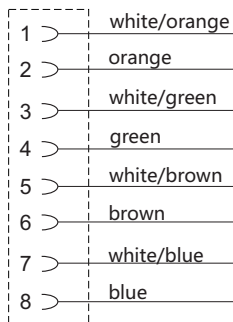

Order No/订货号

Cable length 线材长度	Contacts 芯数	Wire diameter 线径	PVC	TPE
0.1M	8pins	0.25mm ²	120708-04-831	120708-04-841
0.2M	8pins	0.25mm ²	120708-04-832	120708-04-842
0.5M	8pins	0.25mm ²	120708-04-833	120708-04-843
1.0M	8pins	0.25mm ²	120708-04-834	120708-04-844

Specifications/技术参数

Number of contacts/芯数	8
Rated voltage/额定电压	30V
Rated current (40°C)/额定电流	2A
Protection degree/防护等级	IP67/IP68
Operating temperature/工作温度	-25°C ~ +80°C

M12 Circular connectors

Male connector for over-molding

Product figure



Scale diagram

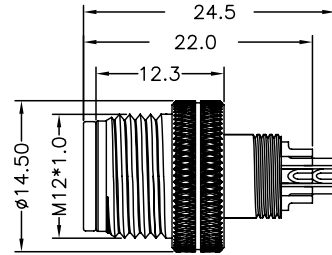

Contact layout/针孔排布 (Front view/前视图)

3pins

4pins

5pins

8pins

12pins

5pins

4pins

A

A

A

A

A

B

D



Order Data/订货信息

Contacts/芯数	Coding	Order No/订货号	P/N/料号
2pins	A	120102-20-001	M12AM02001
3pins	A	120103-20-001	M12AM03001
4pins	A	120104-20-001	M12AM04001
	D	120404-20-002	M12DM04002
5pins	A	120105-20-001	M12AM05001
	B	120205-20-001	M12BM05001
8pins	A	120108-20-001	M12AM08001
12pins	A	120112-20-001	M12AM12001

Specifications/技术参数

Number of contacts/芯数	3	4	5	8	12
Termination/接线方式	solder/焊接				
Wire gauge/线规	0.14/0.25/0.34/0.5mm ² / (26/24/22/20 AWG)				
Operating temperature/工作温度	-25°C ~ +85°C				
Mechanical operation/插拔次数	> 100 mating cycles				
Rated voltage/额定电压	250V		60V	30V	
Rated current (40°C)/额定电流	4A			2A	1.5A
Protection degree/防护等级	IP67/IP68				
Contact resistance/接触电阻	< 10mΩ				
Insulation resistance/绝缘电阻	≥ 100MΩ				
Pin contact/插针材料	CuZn				
Socket contact/插孔材料	CuSn				
Contact plating/针孔镀层材料	Au				

Male connector for over-molding

Product figure



Scale diagram

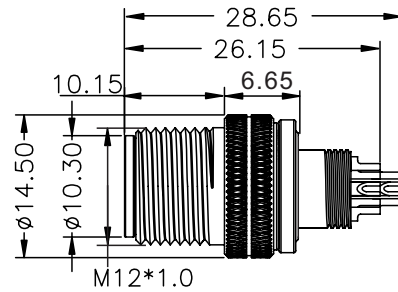

Contact layout/针孔排布 (Front view/前视图)

17pins

A

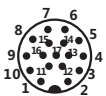

Order Data/订货信息

Contacts/芯数	Coding	Order No/订货号	P/N/料号
17pins	A	120117-20-001	M12AM17001

Specifications/技术参数

Number of contacts/芯数	17
Termination/接线方式	solder/焊接
Wire gauge/线规	0.14/0.25/0.34/0.5mm ² / (26/24/22/20 AWG)
Operating temperature/工作温度	-25°C ~ +85°C
Mechanical operation/插拔次数	> 100 mating cycles
Rated voltage/额定电压	30V
Rated current (40°C)/额定电流	1.5A
Protection degree/防护等级	IP67/IP68
Contact resistance/接触电阻	< 10mΩ
Insulation resistance/绝缘电阻	≥ 100MΩ
Pin contact/插针材料	CuZn
Socket contact/插孔材料	CuSn
Contact plating/针孔镀层材料	Au

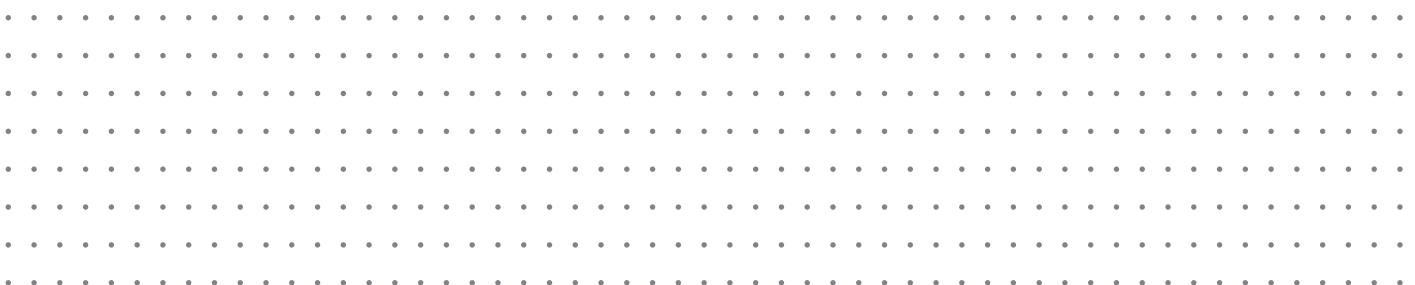

M12 Circular connectors

Female connector for over-molding

Product figure



Scale diagram

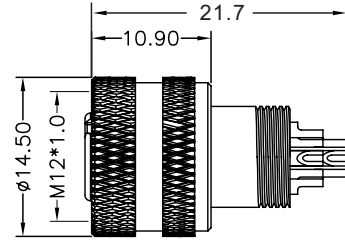

Contact layout/针孔排布 (Front view/前视图)

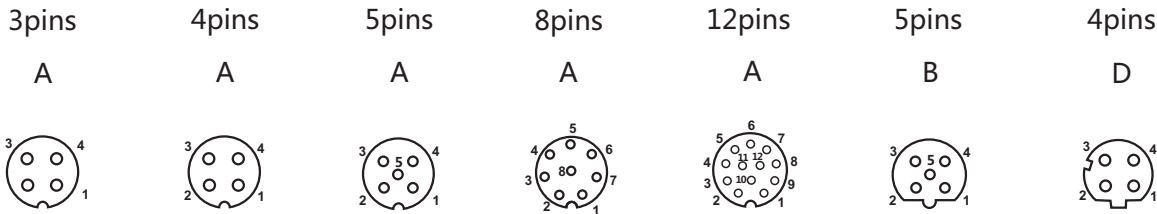

Order Data/订货信息

Contacts/芯数	Coding	Order No/订货号	P/N/料号
2pins	A	120102-21-001	M12AF02001
3pins	A	120103-21-001	M12AF03001
4pins	A	120104-21-001	M12AF04001
	D	120404-21-002	M12DF04002
5pins	A	120105-21-001	M12AF05001
	B	120205-21-001	M12BF05001
8pins	A	120108-21-001	M12AF08001
12pins	A	120112-21-001	M12AF12001

Specifications/技术参数

Number of contacts/芯数	3	4	5	8	12
Termination/接线方式	solder/焊接				
Wire gauge/线规	0.14/0.25/0.34/0.5mm ² / (26/24/22/20 AWG)				
Operating temperature/工作温度	-25°C ~ +85°C				
Mechanical operation/插拔次数	> 100 mating cycles				
Rated voltage/额定电压	250V		60V	30V	
Rated current (40°C)/额定电流	4A			2A	1.5A
Protection degree/防护等级	IP67/IP68				
Contact resistance/接触电阻	< 10mΩ				
Insulation resistance/绝缘电阻	≥ 100MΩ				
Pin contact/插针材料	CuZn				
Socket contact/插孔材料	CuSn				
Contact plating/针孔镀层材料	Au				

Female connector for over-molding

Product figure



Scale diagram

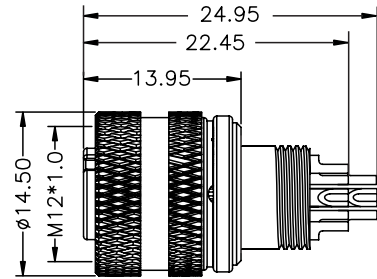

Contact layout/针孔排布 (Front view/前视图)

17pins

A



Order Data/订货信息

Contacts/芯数	Coding	Order No/订货号	P/N/料号
17pins	A	120117-21-001	M12AF17001

Specifications/技术参数

Number of contacts/芯数	17
Termination/接线方式	solder/焊接
Wire gauge/线规	0.14/0.25/0.34/0.5mm ² / (26/24/22/20 AWG)
Operating temperature/工作温度	-25°C ~ +85°C
Mechanical operation/插拔次数	> 100 mating cycles
Rated voltage/额定电压	30V
Rated current (40°C)/额定电流	1.5A
Protection degree/防护等级	IP67/IP68
Contact resistance/接触电阻	< 10mΩ
Insulation resistance/绝缘电阻	≥ 100MΩ
Pin contact/插针材料	CuZn
Socket contact/插孔材料	CuSn
Contact plating/针孔镀层材料	Au

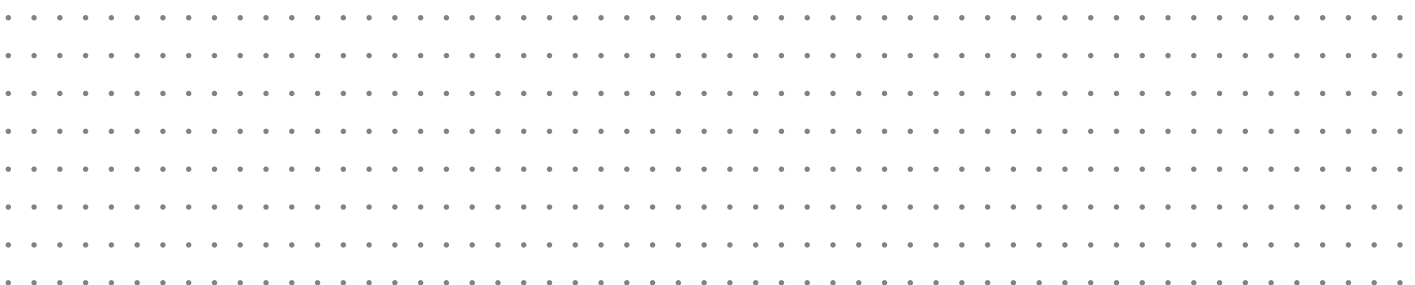

M12 Circular connectors

Male connector for over-molding

Product figure (with shield)



Scale diagram

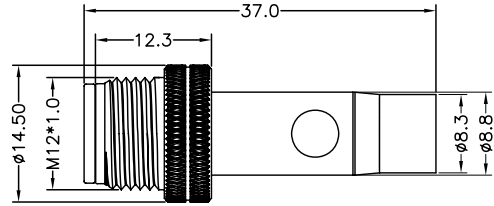

Contact layout/针孔排布 (Front view/前视图)

3pins

4pins

5pins

8pins

12pins

5pins

4pins

A

A

A

A

A

B

D



Order Data/订货信息

Contacts/芯数	Coding	Order No/订货号	P/N/料号
2pins	A	120102-20-002	M12AM02002
3pins	A	120103-20-002	M12AM03002
4pins	A	120104-20-002	M12AM04002
	D	120404-20-001	M12DM04001
5pins	A	120105-20-002	M12AM05002
	B	120205-20-002	M12BM05002
8pins	A	120108-20-002	M12AM08002
12pins	A	120112-20-002	M12AM12002

Specifications/技术参数

Number of contacts/芯数	3	4	5	8	12
Termination/接线方式	solder/焊接				
Wire gauge/线规	0.14/0.25/0.34/0.5mm ² / (26/24/22/20 AWG)				
Operating temperature/工作温度	-25°C ~ +85°C				
Mechanical operation/插拔次数	> 100 mating cycles				
Rated voltage/额定电压	250V		60V	30V	
Rated current (40°C)/额定电流	4A			2A	1.5A
Protection degree/防护等级	IP67/IP68				
Contact resistance/接触电阻	< 10mΩ				
Insulation resistance/绝缘电阻	≥ 100MΩ				
Pin contact/插针材料	CuZn				
Socket contact/插孔材料	CuSn				
Contact plating/针孔镀层材料	Au				

M12 Circular connectors

Male connector for over-molding

Product figure (with shield)



Scale diagram

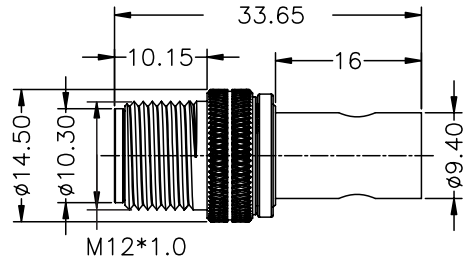

Contact layout/针孔排布 (Front view/前视图)

17pins

A

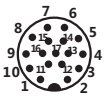

Order Data/订货信息

Contacts/芯数	Coding	Order No/订货号	P/N/料号
17pins	A	120117-20-002	M12AM17002

Specifications/技术参数

Number of contacts/芯数	17
Termination/接线方式	solder/焊接
Wire gauge/线规	0.14/0.25/0.34/0.5mm ² / (26/24/22/20 AWG)
Operating temperature/工作温度	-25°C ~ +85°C
Mechanical operation/插拔次数	> 100 mating cycles
Rated voltage/额定电压	30V
Rated current (40°C)/额定电流	1.5A
Protection degree/防护等级	IP67/IP68
Contact resistance/接触电阻	< 10mΩ
Insulation resistance/绝缘电阻	≥ 100MΩ
Pin contact/插针材料	CuZn
Socket contact/插孔材料	CuSn
Contact plating/针孔镀层材料	Au

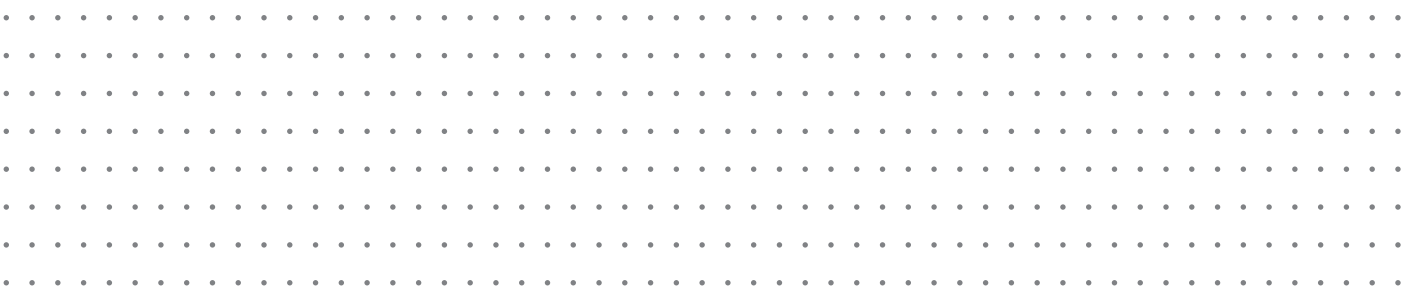

M12 Circular connectors

Female connector for over-molding

Product figure (with shield)



Scale diagram

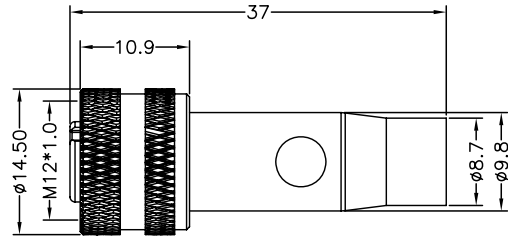

Contact layout/针孔排布 (Front view/前视图)

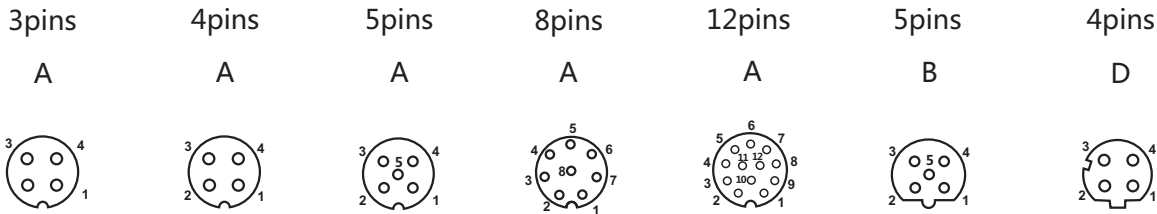

Order Data/订货信息

Contacts/芯数	Coding	Order No/订货号	P/N/料号
2pins	A	120102-21-002	M12AF02002
3pins	A	120103-21-002	M12AF03002
4pins	A	120104-21-002	M12AF04002
	D	120404-21-001	M12DF04001
5pins	A	120105-21-002	M12AF05002
	B	120205-21-002	M12BF05002
8pins	A	120108-21-002	M12AF08002
12pins	A	120112-21-002	M12AF12002

Specifications/技术参数

Number of contacts/芯数	3	4	5	8	12
Termination/接线方式	solder/焊接				
Wire gauge/线规	0.14/0.25/0.34/0.5mm ² / (26/24/22/20 AWG)				
Operating temperature/工作温度	-25°C ~ +85°C				
Mechanical operation/插拔次数	> 100 mating cycles				
Rated voltage/额定电压	250V		60V	30V	
Rated current (40°C)/额定电流	4A			2A	1.5A
Protection degree/防护等级	IP67/IP68				
Contact resistance/接触电阻	< 10mΩ				
Insulation resistance/绝缘电阻	≥ 100MΩ				
Pin contact/插针材料	CuZn				
Socket contact/插孔材料	CuSn				
Contact plating/针孔镀层材料	Au				

M12 Circular connectors

Male connector for over-molding

Product figure



Scale diagram

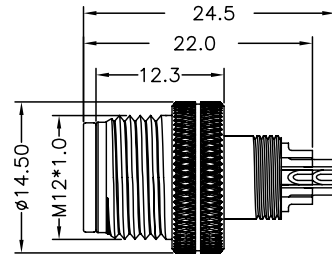

Contact layout/针孔排布 (Front view/前视图)

3pins

4pins

5pins

6pins

C

C

C

C



Order Data/订货信息

Contacts/芯数	Coding	Order No/订货号	P/N/料号
3pins	C	120303-20-001	M12CM03001
4pins	C	120304-20-001	M12CM04001
5pins	C	120305-20-001	M12CM05001
6pins	C	120306-20-001	M12CM06001

Specifications/技术参数

Number of contacts/芯数	3	4	5	6
Termination/接线方式	solder/焊接			
Wire gauge/线规	0.14/0.25/0.34/0.5mm ² / (26/24/22/20 AWG)			
Operating temperature/工作温度	-25°C ~ +85°C			
Mechanical operation/插拔次数	> 100 mating cycles			
Rated voltage/额定电压	250V		60V	30V
Rated current (40°C)/额定电流	4A		2A	
Protection degree/防护等级	IP67			
Contact resistance/接触电阻	< 10mΩ			
Insulation resistance/绝缘电阻	≥ 100MΩ			
Pin contact/插针材料	CuZn			
Socket contact/插孔材料	CuSn			
Contact plating/针孔镀层材料	Au			

Female connector for over-molding

Product figure



Scale diagram

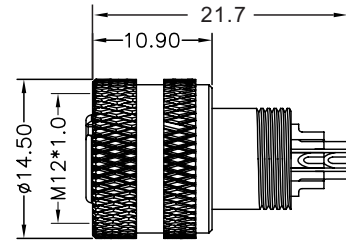

Contact layout/针孔排布 (Front view/前视图)

3pins

4pins

5pins

6pins

C

C

C

C



Order Data/订货信息

Contacts/芯数	Coding	Order No/订货号	P/N/料号
3pins	C	120303-21-001	M12CF03001
4pins	C	120304-21-001	M12CF04001
5pins	C	120305-21-001	M12CF05001
6pins	C	120306-21-001	M12CF06001

Specifications/技术参数

Number of contacts/芯数	3	4	5	6
Termination/接线方式	solder/焊接			
Wire gauge/线规	0.14/0.25/0.34/0.5mm ² / (26/24/22/20 AWG)			
Operating temperature/工作温度	-25°C ~ +85°C			
Mechanical operation/插拔次数	> 100 mating cycles			
Rated voltage/额定电压	250V		60V	30V
Rated current (40°C)/额定电流	4A		2A	
Protection degree/防护等级	IP67			
Contact resistance/接触电阻	< 10mΩ			
Insulation resistance/绝缘电阻	≥ 100MΩ			
Pin contact/插针材料	CuZn			
Socket contact/插孔材料	CuSn			
Contact plating/针孔镀层材料	Au			

M12 Circular connectors

Male connector for over-molding

Product figure (with shield)



Scale diagram

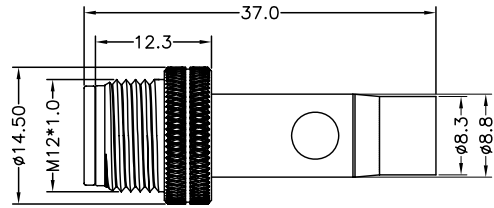

Contact layout/针孔排布 (Front view/前视图)

3pins

4pins

5pins

6pins

C

C

C

C



Order Data/订货信息

Contacts/芯数	Coding	Order No/订货号	P/N/料号
3pins	C	120303-20-002	M12CM03002
4pins	C	120304-20-002	M12CM04002
5pins	C	120305-20-002	M12CM05002
6pins	C	120306-20-002	M12CM06002

Specifications/技术参数

Number of contacts/芯数	3	4	5	6
Termination/接线方式	solder/焊接			
Wire gauge/线规	0.14/0.25/0.34/0.5mm ² / (26/24/22/20 AWG)			
Operating temperature/工作温度	-25°C ~ +85°C			
Mechanical operation/插拔次数	> 100 mating cycles			
Rated voltage/额定电压	250V		60V	30V
Rated current (40°C)/额定电流	4A		2A	
Protection degree/防护等级	IP67			
Contact resistance/接触电阻	< 10mΩ			
Insulation resistance/绝缘电阻	≥ 100MΩ			
Pin contact/插针材料	CuZn			
Socket contact/插孔材料	CuSn			
Contact plating/针孔镀层材料	Au			

M12 Circular connectors

Female connector for over-molding

Product figure (with shield)



Scale diagram

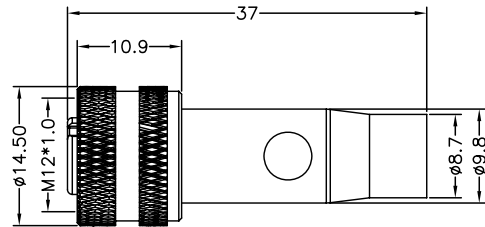

Contact layout/针孔排布 (Front view/前视图)

3pins

4pins

5pins

6pins

C

C

C

C



Order Data/订货信息

Contacts/芯数	Coding	Order No/订货号	P/N/料号
3pins	C	120303-21-002	M12CF03002
4pins	C	120304-21-002	M12CF04002
5pins	C	120305-21-002	M12CF05002
6pins	C	120306-21-002	M12CF06002

Specifications/技术参数

Number of contacts/芯数	3	4	5	6
Termination/接线方式	solder/焊接			
Wire gauge/线规	0.14/0.25/0.34/0.5mm ² / (26/24/22/20 AWG)			
Operating temperature/工作温度	-25°C ~ +85°C			
Mechanical operation/插拔次数	> 100 mating cycles			
Rated voltage/额定电压	250V		60V	30V
Rated current (40°C)/额定电流	4A		2A	
Protection degree/防护等级	IP67			
Contact resistance/接触电阻	< 10mΩ			
Insulation resistance/绝缘电阻	≥ 100MΩ			
Pin contact/插针材料	CuZn			
Socket contact/插孔材料	CuSn			
Contact plating/针孔镀层材料	Au			

M12 Circular connectors

Male panel connector

Product figure (M16*1.5 rear fastened solder)

Scale diagram

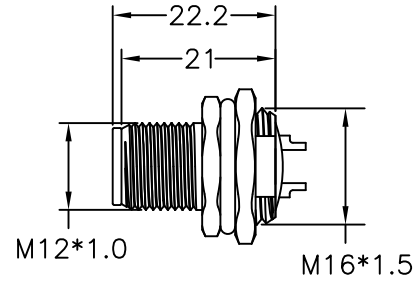

Contact layout/针孔排布 (Front view/前视图)

3pins

4pins

5pins

8pins

12pins

17pins

5pins

4pins

A

A

A

A

A

A

B

D



Order Data/订货信息

Contacts/芯数	Coding	Order No/订货号	P/N/料号
2pins	A	120102-03-001	PMM12BAM02001
3pins	A	120103-03-001	PMM12BAM03001
4pins	A	120104-03-001	PMM12BAM04001
	D	120404-03-019	PMM12BDM04017
5pins	A	120105-03-001	PMM12BAM05001
	B	120205-03-001	PMM12BBM05001
8pins	A	120108-03-001	PMM12BAM08001
12pins	A	120112-03-001	PMM12BAM12001
17pins	A	120117-03-001	PMM12BAM17001

Specifications/技术参数

Number of contacts/芯数	3	4	5	8	12	17
Termination/接线方式	solder/焊线式					
Wire gauge/线规	0.14/0.25/0.34/0.5mm ² / (26/24/22/20 AWG)					
Operating temperature/工作温度	-25°C ~ +80°C					
Mechanical operation/插拔次数	> 100 mating cycles					
Rated voltage/额定电压	250V		60V		30V	
Rated current (40°C)/额定电流	4A			2A		1.5A
Protection degree/防护等级	IP67/IP68					
Contact resistance/接触电阻	< 10mΩ					
Insulation resistance/绝缘电阻	≥ 100MΩ					
Pin contact/插针材料	CuZn					
Socket contact/插孔材料	CuSn					
Contact plating/针孔镀层材料	Au					

M12 Circular connectors

Female panel connector

Product figure (M16*1.5 rear fastened solder)



Scale diagram

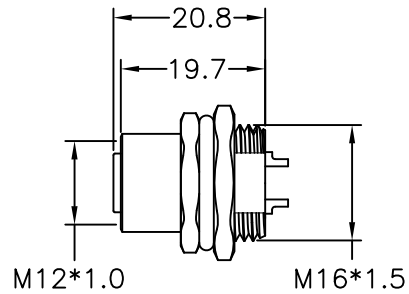

Contact layout/针孔排布 (Front view/前视图)

3pins

A



4pins

A



5pins

A



8pins

A



12pins

A

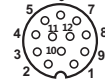

17pins

A



5pins

B



4pins

D



Order Data/订货信息

Contacts/芯数	Coding	Order No/订货号	P/N/料号
2pins	A	120102-04-001	PMM12BAF02001
3pins	A	120103-04-001	PMM12BAF03001
4pins	A	120104-04-001	PMM12BAF04001
	D	120404-04-007	PMM12BDF04006
5pins	A	120105-04-001	PMM12BAF05001
	B	120205-04-001	PMM12BBF05001
8pins	A	120108-04-001	PMM12BAF08001
12pins	A	120112-04-001	PMM12BAF12001
17pins	A	120117-04-001	PMM12BAF17001

Specifications/技术参数

Number of contacts/芯数	3	4	5	8	12	17
Termination/接线方式	solder/焊线式					
Wire gauge/线规	0.14/0.25/0.34/0.5mm ² / (26/24/22/20 AWG)					
Operating temperature/工作温度	-25°C ~ +80°C					
Mechanical operation/插拔次数	> 100 mating cycles					
Rated voltage/额定电压	250V		60V		30V	
Rated current (40°C)/额定电流	4A			2A		1.5A
Protection degree/防护等级	IP67/IP68					
Contact resistance/接触电阻	< 10mΩ					
Insulation resistance/绝缘电阻	≥ 100MΩ					
Pin contact/插针材料	CuZn					
Socket contact/插孔材料	CuSn					
Contact plating/针孔镀层材料	Au					

M12 Circular connectors

Male panel connector

Product figure (PG9 rear fastened solder)

Scale diagram

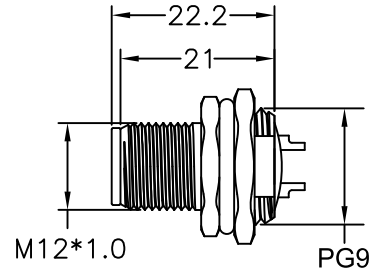

Contact layout/针孔排布 (Front view/前视图)

3pins

4pins

5pins

8pins

12pins

17pins

5pins

4pins

A

A

A

A

A

A

B

D



Order Data/订货信息

Contacts/芯数	Coding	Order No/订货号	P/N/料号
2pins	A	120102-03-002	PMM12BAM02002
3pins	A	120103-03-002	PMM12BAM03002
4pins	A	120104-03-002	PMM12BAM04002
	D	120404-03-001	PMM12BDM04001
5pins	A	120105-03-002	PMM12BAM05002
	B	120205-03-002	PMM12BBM05002
8pins	A	120108-03-002	PMM12BAM08002
12pins	A	120112-03-002	PMM12BAM12002
17pins	A	120117-03-002	PMM12BAM17002

Specifications/技术参数

Number of contacts/芯数	3	4	5	8	12	17
Termination/接线方式	solder/焊线式					
Wire gauge/线规	0.14/0.25/0.34/0.5mm ² / (26/24/22/20 AWG)					
Operating temperature/工作温度	-25°C~+80°C					
Mechanical operation/插拔次数	> 100 mating cycles					
Rated voltage/额定电压	250V		60V		30V	
Rated current (40°C)/额定电流	4A			2A		1.5A
Protection degree/防护等级	IP67/IP68					
Contact resistance/接触电阻	< 10mΩ					
Insulation resistance/绝缘电阻	≥100MΩ					
Pin contact/插针材料	CuZn					
Socket contact/插孔材料	CuSn					
Contact plating/针孔镀层材料	Au					

M12 Circular connectors

Female panel connector

Product figure (PG9 rear fastened solder)



Scale diagram

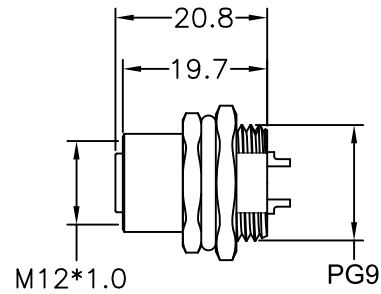

Contact layout/针孔排布 (Front view/前视图)

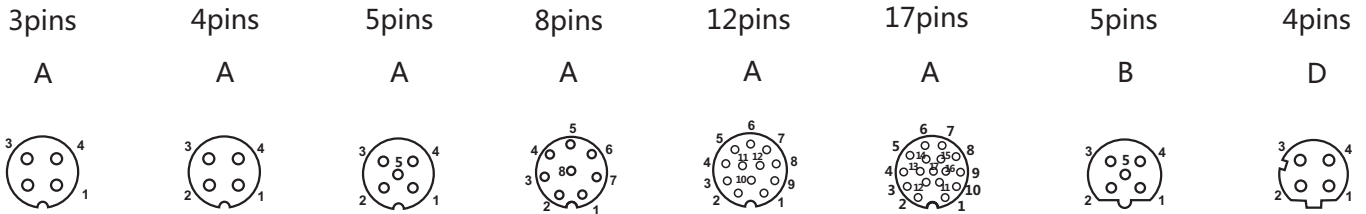

Order Data/订货信息

Contacts/芯数	Coding	Order No/订货号	P/N/料号
2pins	A	120102-04-002	PMM12BAF02002
3pins	A	120103-04-002	PMM12BAF03002
4pins	A	120104-04-002	PMM12BAF04002
	D	120404-04-003	PMM12BDF04002
5pins	A	120105-04-002	PMM12BAF05002
	B	120205-04-002	PMM12BBF05002
8pins	A	120108-04-002	PMM12BAF08002
12pins	A	120112-04-002	PMM12BAF12002
17pins	A	120117-04-002	PMM12BAF17002

Specifications/技术参数

Number of contacts/芯数	3	4	5	8	12	17
Termination/接线方式	solder/焊线式					
Wire gauge/线规	0.14/0.25/0.34/0.5mm ² / (26/24/22/20 AWG)					
Operating temperature/工作温度	-25°C ~ +80°C					
Mechanical operation/插拔次数	> 100 mating cycles					
Rated voltage/额定电压	250V		60V		30V	
Rated current (40°C)/额定电流	4A			2A		1.5A
Protection degree/防护等级	IP67/IP68					
Contact resistance/接触电阻	< 10mΩ					
Insulation resistance/绝缘电阻	≥ 100MΩ					
Pin contact/插针材料	CuZn					
Socket contact/插孔材料	CuSn					
Contact plating/针孔镀层材料	Au					

M12 Circular connectors

Male panel connector

Product figure (rear fastened PG9, long shell solder)

Scale diagram

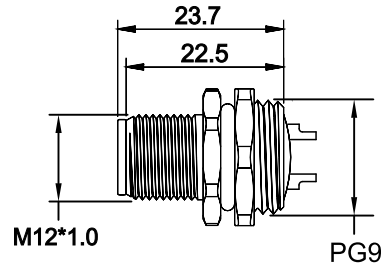

Contact layout/针孔排布 (Front view/前视图)

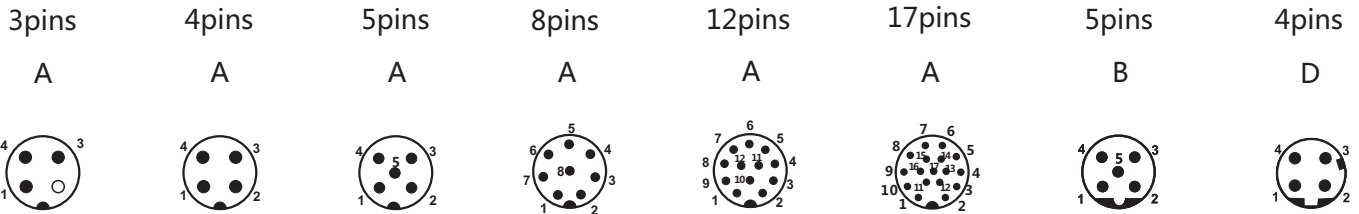

Order Data/订货信息

Contacts/芯数	Coding	Order No/订货号	P/N/料号
2pins	A	120102-03-003	PMM12BAM02005
3pins	A	120103-03-003	PMM12BAM03005
4pins	A	120104-03-003	PMM12BAM04005
	D	120404-03-007	PMM12BDM04007
5pins	A	120105-03-003	PMM12BAM05005
	B	120205-03-007	PMM12BBM05007
8pins	A	120108-03-003	PMM12BAM08005
12pins	A	120112-03-003	PMM12BAM12005
17pins	A	120117-03-003	PMM12BAM17005

Specifications/技术参数

Number of contacts/芯数	3	4	5	8	12	17
Termination/接线方式	solder/焊线式					
Wire gauge/线规	0.14/0.25/0.34/0.5mm ² / (26/24/22/20 AWG)					
Operating temperature/工作温度	-25°C ~ +80°C					
Mechanical operation/插拔次数	> 100 mating cycles					
Rated voltage/额定电压	250V		60V		30V	
Rated current (40°C)/额定电流	4A			2A		1.5A
Protection degree/防护等级	IP67/IP68					
Contact resistance/接触电阻	< 10mΩ					
Insulation resistance/绝缘电阻	≥ 100MΩ					
Pin contact/插针材料	CuZn					
Socket contact/插孔材料	CuSn					
Contact plating/针孔镀层材料	Au					

M12 Circular connectors

Female panel connector

Product figure (rear fastened PG9, long shell solder)

Scale diagram

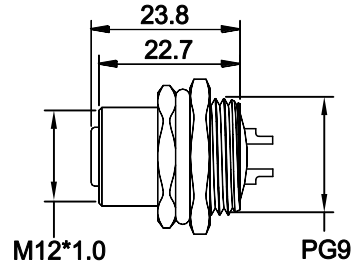

Contact layout/针孔排布 (Front view/前视图)

3pins

4pins

5pins

8pins

12pins

17pins

5pins

4pins

A

A

A

A

A

A

B

D



Order Data/订货信息

Contacts/芯数	Coding	Order No/订货号	P/N/料号
2pins	A	120102-04-003	PMM12BAF02005
3pins	A	120103-04-003	PMM12BAF03005
4pins	A	120104-04-003	PMM12BAF04005
	D	120404-04-010	PMM12BDF04009
5pins	A	120105-04-003	PMM12BAF05005
	B	120205-04-005	PMM12BBF05005
8pins	A	120108-04-003	PMM12BAF08005
12pins	A	120112-04-003	PMM12BAF12005
17pins	A	120117-04-003	PMM12BAF17005

Specifications/技术参数

Number of contacts/芯数	3	4	5	8	12	17
Termination/接线方式	solder/焊线式					
Wire gauge/线规	0.14/0.25/0.34/0.5mm ² / (26/24/22/20 AWG)					
Operating temperature/工作温度	-25°C ~ +80°C					
Mechanical operation/插拔次数	> 100 mating cycles					
Rated voltage/额定电压	250V		60V		30V	
Rated current (40°C)/额定电流	4A			2A		1.5A
Protection degree/防护等级	IP67/IP68					
Contact resistance/接触电阻	< 10mΩ					
Insulation resistance/绝缘电阻	≥ 100MΩ					
Pin contact/插针材料	CuZn					
Socket contact/插孔材料	CuSn					
Contact plating/针孔镀层材料	Au					

M12 Circular connectors

Male panel connector

Product figure (M12*1.0 rear fastened solder)

Scale diagram

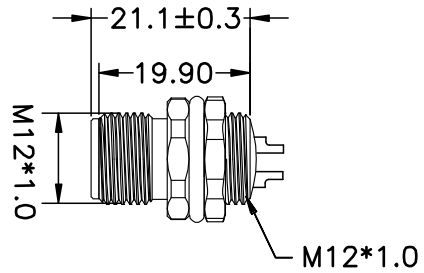

Contact layout/针孔排布 (Front view/前视图)

3pins

4pins

5pins

8pins

12pins

17pins

5pins

4pins

A

A

A

A

A

A

B

D



Order Data/订货信息

Contacts/芯数	Coding	Order No/订货号	P/N/料号
2pins	A	120102-03-019	PMM12BAM02017
3pins	A	120103-03-021	PMM12BAM03017
4pins	A	120104-03-037	PMM12BAM04019
	D	120404-03-022	PMM12BDM04020
5pins	A	120105-03-033	PMM12BAM05019
	B	120205-03-019	PMM12BBM05017
8pins	A	120108-03-039	PMM12BAM08018
12pins	A	120112-03-025	PMM12BAM12019
17pins	A	120117-03-019	PMM12BAM17017

Specifications/技术参数

Number of contacts/芯数	3	4	5	8	12	17
Termination/接线方式	solder/焊线式					
Wire gauge/线规	0.14/0.25/0.34/0.5mm ² / (26/24/22/20 AWG)					
Operating temperature/工作温度	-25°C~+80°C					
Mechanical operation/插拔次数	> 100 mating cycles					
Rated voltage/额定电压	250V		60V		30V	
Rated current (40°C)/额定电流	4A			2A		1.5A
Protection degree/防护等级	IP67/IP68					
Contact resistance/接触电阻	< 10mΩ					
Insulation resistance/绝缘电阻	≥100MΩ					
Pin contact/插针材料	CuZn					
Socket contact/插孔材料	CuSn					
Contact plating/针孔镀层材料	Au					

M12 Circular connectors

Male panel connector

Product figure (M16*1.5 front fastened solder)



Scale diagram

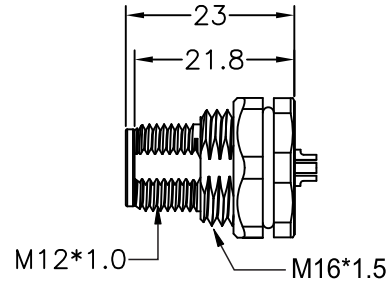

Contact layout/针孔排布 (Front view/前视图)

3pins

A



4pins

A



5pins

A



8pins

A



12pins

A



17pins

A



5pins

B



4pins

D



Order Data/订货信息

Contacts/芯数	Coding	Order No/订货号	P/N/料号
2pins	A	120102-03-006	PMM12FAM02003
3pins	A	120103-03-006	PMM12FAM03003
4pins	A	120104-03-006	PMM12FAM04003
	D	120404-03-020	PMM12FDM04018
5pins	A	120105-03-022	PMM12FAM05003
	B	120205-03-003	PMM12FBM05003
8pins	A	120108-03-006	PMM12FAM08003
12pins	A	120112-03-006	PMM12FAM12003
17pins	A	120117-03-006	PMM12FAM17003

Specifications/技术参数

Number of contacts/芯数	3	4	5	8	12	17
Termination/接线方式	solder/焊线式					
Wire gauge/线规	0.14/0.25/0.34/0.5mm ² / (26/24/22/20 AWG)					
Operating temperature/工作温度	-25°C ~ +80°C					
Mechanical operation/插拔次数	> 100 mating cycles					
Rated voltage/额定电压	250V		60V		30V	
Rated current (40°C)/额定电流	4A			2A		1.5A
Protection degree/防护等级	IP67/IP68					
Contact resistance/接触电阻	< 10mΩ					
Insulation resistance/绝缘电阻	≥ 100MΩ					
Pin contact/插针材料	CuZn					
Socket contact/插孔材料	CuSn					
Contact plating/针孔镀层材料	Au					

M12 Circular connectors

Female panel connector

Product figure (M16*1.5 front fastened solder)

Scale diagram

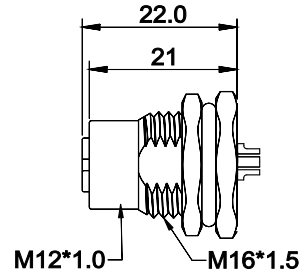

Contact layout/针孔排布 (Front view/前视图)

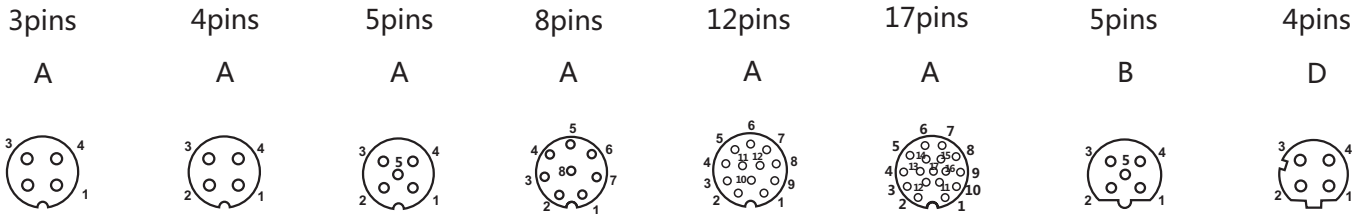

Order Data/订货信息

Contacts/芯数	Coding	Order No/订货号	P/N/料号
2pins	A	120102-04-006	PMM12FAF02003
3pins	A	120103-04-006	PMM12FAF03003
4pins	A	120104-04-006	PMM12FAF04003
	D	120404-04-008	PMM12FDF04007
5pins	A	120105-04-006	PMM12FAF05003
	B	120205-04-003	PMM12FBF05003
8pins	A	120108-04-006	PMM12FAF08003
12pins	A	120112-04-006	PMM12FAF12003
17pins	A	120117-04-006	PMM12FAF17003

Specifications/技术参数

Number of contacts/芯数	3	4	5	8	12	17
Termination/接线方式	solder/焊线式					
Wire gauge/线规	0.14/0.25/0.34/0.5mm ² / (26/24/22/20 AWG)					
Operating temperature/工作温度	-25°C ~ +80°C					
Mechanical operation/插拔次数	> 100 mating cycles					
Rated voltage/额定电压	250V		60V		30V	
Rated current (40°C)/额定电流	4A			2A		1.5A
Protection degree/防护等级	IP67/IP68					
Contact resistance/接触电阻	< 10mΩ					
Insulation resistance/绝缘电阻	≥ 100MΩ					
Pin contact/插针材料	CuZn					
Socket contact/插孔材料	CuSn					
Contact plating/针孔镀层材料	Au					

M12 Circular connectors

Male panel connector

Product figure (PG9 front fastened solder)



Scale diagram

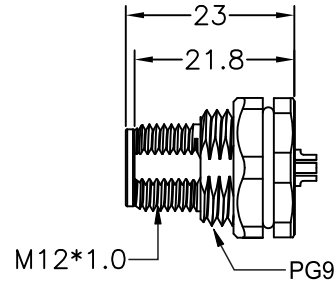

Contact layout/针孔排布 (Front view/前视图)

3pins

A



4pins

A



5pins

A



8pins

A



12pins

A



17pins

A



5pins

B



4pins

D



Order Data/订货信息

Contacts/芯数	Coding	Order No/订货号	P/N/料号
2pins	A	120102-03-007	PMM12FAM02004
3pins	A	120103-03-007	PMM12FAM03004
4pins	A	120104-03-007	PMM12FAM04004
	D	120404-03-021	PMM12FDM04019
5pins	A	120105-03-006	PMM12FAM05004
	B	120205-03-004	PMM12FBM05004
8pins	A	120108-03-007	PMM12FAM08004
12pins	A	120112-03-007	PMM12FAM12004
17pins	A	120117-03-007	PMM12FAM17004

Specifications/技术参数

Number of contacts/芯数	3	4	5	8	12	17
Termination/接线方式	solder/焊线式					
Wire gauge/线规	0.14/0.25/0.34/0.5mm ² / (26/24/22/20 AWG)					
Operating temperature/工作温度	-25°C ~ +80°C					
Mechanical operation/插拔次数	> 100 mating cycles					
Rated voltage/额定电压	250V		60V		30V	
Rated current (40°C)/额定电流	4A			2A		1.5A
Protection degree/防护等级	IP67/IP68					
Contact resistance/接触电阻	< 10mΩ					
Insulation resistance/绝缘电阻	≥ 100MΩ					
Pin contact/插针材料	CuZn					
Socket contact/插孔材料	CuSn					
Contact plating/针孔镀层材料	Au					

M12 Circular connectors

Female panel connector

Product figure (PG9 front fastened solder)

Scale diagram

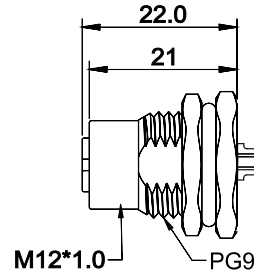

Contact layout/针孔排布 (Front view/前视图)

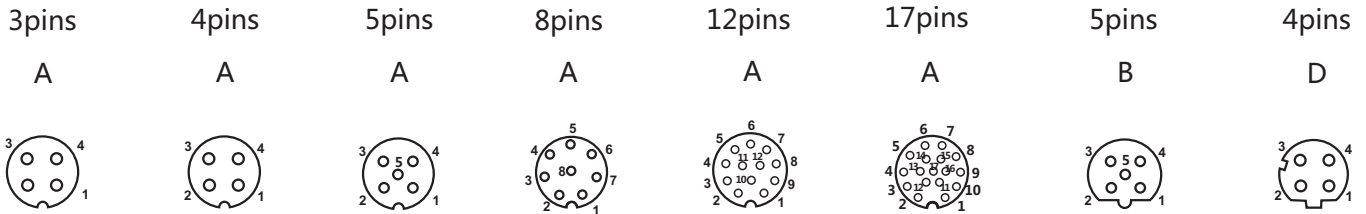

Order Data/订货信息

Contacts/芯数	Coding	Order No/订货号	P/N/料号
2pins	A	120102-04-007	PMM12FAF02004
3pins	A	120103-04-007	PMM12FAF03004
4pins	A	120104-04-007	PMM12FAF04004
	D	120404-04-009	PMM12FDF04012
5pins	A	120105-04-007	PMM12FAF05004
	B	120205-04-004	PMM12FBF05004
8pins	A	120108-04-007	PMM12FAF08004
12pins	A	120112-04-007	PMM12FAF12004
17pins	A	120117-04-007	PMM12FAF17004

Specifications/技术参数

Number of contacts/芯数	3	4	5	8	12	17
Termination/接线方式	solder/焊线式					
Wire gauge/线规	0.14/0.25/0.34/0.5mm ² / (26/24/22/20 AWG)					
Operating temperature/工作温度	-25°C ~ +80°C					
Mechanical operation/插拔次数	> 100 mating cycles					
Rated voltage/额定电压	250V		60V		30V	
Rated current (40°C)/额定电流	4A			2A		1.5A
Protection degree/防护等级	IP67/IP68					
Contact resistance/接触电阻	< 10mΩ					
Insulation resistance/绝缘电阻	≥ 100MΩ					
Pin contact/插针材料	CuZn					
Socket contact/插孔材料	CuSn					
Contact plating/针孔镀层材料	Au					

M12 Circular connectors

Male panel connector

Product figure (M12*1.0 front fastened solder)

Scale diagram

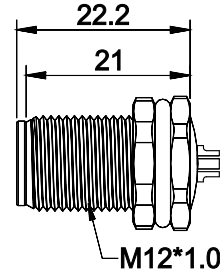

Contact layout/针孔排布 (Front view/前视图)

3pins

4pins

5pins

8pins

12pins

17pins

5pins

4pins

A

A

A

A

A

A

B

D



Order Data/订货信息

Contacts/芯数	Coding	Order No/订货号	P/N/料号
2pins	A	120102-03-011	PMM12FAM02011
3pins	A	120103-03-011	PMM12FAM03011
4pins	A	120104-03-011	PMM12FAM04011
	D	120404-03-005	PMM12FDM04005
5pins	A	120105-03-010	PMM12FAM05011
	B	120205-03-005	PMM12FBM05005
8pins	A	120108-03-011	PMM12FAM08011
12pins	A	120112-03-011	PMM12FAM12011
17pins	A	120117-03-011	PMM12FAM17011

Specifications/技术参数

Number of contacts/芯数	3	4	5	8	12	17
Termination/接线方式	solder/焊线式					
Wire gauge/线规	0.14/0.25/0.34/0.5mm ² / (26/24/22/20 AWG)					
Operating temperature/工作温度	-25°C ~ +80°C					
Mechanical operation/插拔次数	> 100 mating cycles					
Rated voltage/额定电压	250V		60V		30V	
Rated current (40°C)/额定电流	4A			2A		1.5A
Protection degree/防护等级	IP67/IP68					
Contact resistance/接触电阻	< 10mΩ					
Insulation resistance/绝缘电阻	≥ 100MΩ					
Pin contact/插针材料	CuZn					
Socket contact/插孔材料	CuSn					
Contact plating/针孔镀层材料	Au					

M12 Circular connectors

Male plastic panel connector

Product figure (M12*1.0 front fastened solder)

Scale diagram

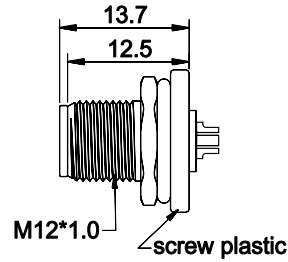

Contact layout/针孔排布 (Front view/前视图)

3pins

4pins

5pins

8pins

12pins

5pins

4pins

A

A

A

A

A

B

D



Order Data/订货信息

Contacts/芯数	Coding	Order No/订货号	P/N/料号
2pins	A	120102-03-014	PMM12FAM02014
3pins	A	120103-03-014	PMM12FAM03014
4pins	A	120104-03-014	PMM12FAM04014
	D	120404-03-006	PMM12FDM04006
5pins	A	120105-03-013	PMM12FAM05014
	B	120205-03-006	PMM12FBM05006
8pins	A	120108-03-014	PMM12FAM08014
12pins	A	120112-03-014	PMM12FAM12014

Specifications/技术参数

Number of contacts/芯数	3	4	5	8	12	17
Termination/接线方式	solder/焊线式					
Wire gauge/线规	0.14/0.25/0.34/0.5mm ² / (26/24/22/20 AWG)					
Operating temperature/工作温度	-25°C ~ +80°C					
Mechanical operation/插拔次数	> 100 mating cycles					
Rated voltage/额定电压	250V		60V		30V	
Rated current (40°C)/额定电流	4A			2A		1.5A
Protection degree/防护等级	IP67/IP68					
Contact resistance/接触电阻	< 10mΩ					
Insulation resistance/绝缘电阻	≥ 100MΩ					
Pin contact/插针材料	CuZn					
Socket contact/插孔材料	CuSn					
Contact plating/针孔镀层材料	Au					

M12 Circular connectors

Male panel connector

Product figure (flanged fixed solder)



Scale diagram

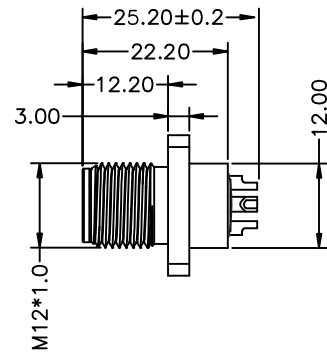

Contact layout/针孔排布 (Front view/前视图)

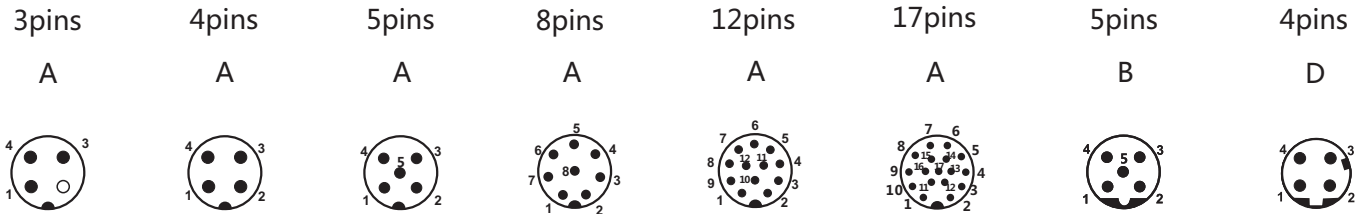

Order Data/订货信息

Contacts/芯数	Coding	Order No/订货号	P/N/料号
2pins	A	120102-03-017	PMM12LAM02001
3pins	A	120103-03-017	PMM12LAM03001
4pins	A	120104-03-018	PMM12LAM04001
	D	120404-03-008	PMM12LDM04001
5pins	A	120105-03-016	PMM12LAM05001
	B	120205-03-008	PMM12LBM05001
8pins	A	120108-03-017	PMM12LAM08001
12pins	A	120112-03-017	PMM12LAM12001
17pins	A	120117-03-017	PMM12LAM17001

Specifications/技术参数

Number of contacts/芯数	3	4	5	8	12	17
Termination/接线方式	solder/焊线式					
Wire gauge/线规	0.14/0.25/0.34/0.5mm ² / (26/24/22/20 AWG)					
Operating temperature/工作温度	-25°C ~ +80°C					
Mechanical operation/插拔次数	> 100 mating cycles					
Rated voltage/额定电压	250V		60V		30V	
Rated current (40°C)/额定电流	4A			2A		1.5A
Protection degree/防护等级	IP67/IP68					
Contact resistance/接触电阻	< 10mΩ					
Insulation resistance/绝缘电阻	≥ 100MΩ					
Pin contact/插针材料	CuZn					
Socket contact/插孔材料	CuSn					
Contact plating/针孔镀层材料	Au					

M12 Circular connectors

Female panel connector

Product figure (flanged fixed solder)

Scale diagram

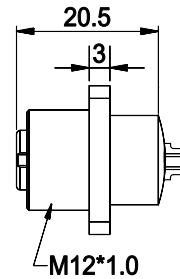

Contact layout/针孔排布 (Front view/前视图)

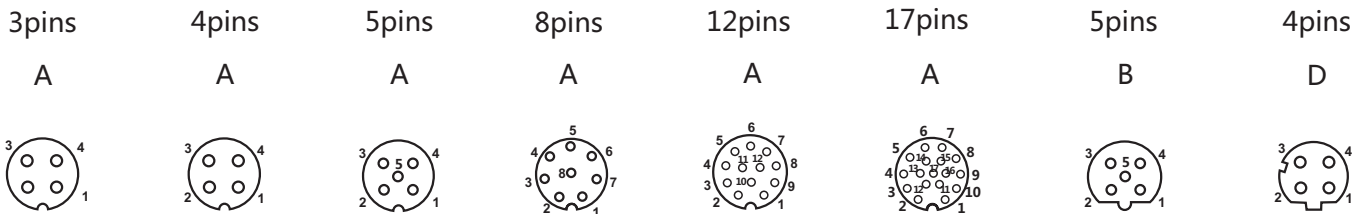

Order Data/订货信息

Contacts/芯数	Coding	Order No/订货号	P/N/料号
2pins	A	120102-04-012	PMM12LAF02001
3pins	A	120103-04-012	PMM12LAF03001
4pins	A	120104-04-012	PMM12LAF04001
	D	120404-04-011	PMM12LDF04001
5pins	A	120105-04-012	PMM12LAF05001
	B	120205-04-006	PMM12LBF05006
8pins	A	120108-04-012	PMM12LAF08001
12pins	A	120112-04-012	PMM12LAF12001
17pins	A	120117-04-012	PMM12LAF17001

Specifications/技术参数

Number of contacts/芯数	3	4	5	8	12	17
Termination/接线方式	solder/焊线式					
Wire gauge/线规	0.14/0.25/0.34/0.5mm ² / (26/24/22/20 AWG)					
Operating temperature/工作温度	-25°C ~ +80°C					
Mechanical operation/插拔次数	> 100 mating cycles					
Rated voltage/额定电压	250V		60V		30V	
Rated current (40°C)/额定电流	4A			2A		1.5A
Protection degree/防护等级	IP67/IP68					
Contact resistance/接触电阻	< 10mΩ					
Insulation resistance/绝缘电阻	≥ 100MΩ					
Pin contact/插针材料	CuZn					
Socket contact/插孔材料	CuSn					
Contact plating/针孔镀层材料	Au					

Male panel connector

Product figure (flanged fixed solder)



Scale diagram

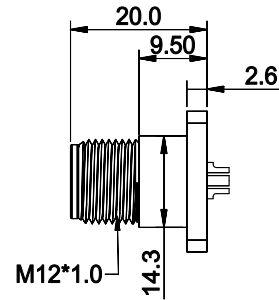

Contact layout/针孔排布 (Front view/前视图)

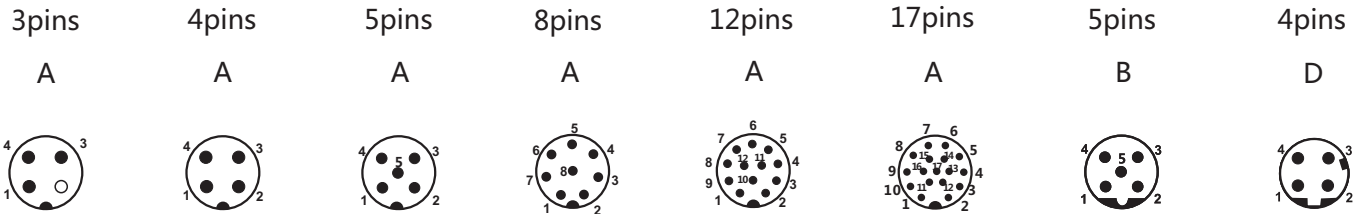

Order Data/订货信息

Contacts/芯数	Coding	Order No/订货号	P/N/料号
2pins	A	120102-03-018	PMM12LAM02002
3pins	A	120103-03-018	PMM12LAM03002
4pins	A	120104-03-019	PMM12LAM04002
	D	120404-03-009	PMM12LDM04002
5pins	A	120105-03-017	PMM12LAM05002
	B	120205-03-009	PMM12LBM05002
8pins	A	120108-03-018	PMM12LAM08002
12pins	A	120112-03-018	PMM12LAM12002
17pins	A	120117-03-018	PMM12LAM17002

Specifications/技术参数

Number of contacts/芯数	3	4	5	8	12	17
Termination/接线方式	solder/焊线式					
Wire gauge/线规	0.14/0.25/0.34/0.5mm ² / (26/24/22/20 AWG)					
Operating temperature/工作温度	-25°C ~ +80°C					
Mechanical operation/插拔次数	> 100 mating cycles					
Rated voltage/额定电压	250V		60V		30V	
Rated current (40°C)/额定电流	4A			2A		1.5A
Protection degree/防护等级	IP67/IP68					
Contact resistance/接触电阻	< 10mΩ					
Insulation resistance/绝缘电阻	≥ 100MΩ					
Pin contact/插针材料	CuZn					
Socket contact/插孔材料	CuSn					
Contact plating/针孔镀层材料	Au					

M12 Circular connectors

Male panel connector

Product figure (M16*1.5 rear fastened DIP)

Scale diagram

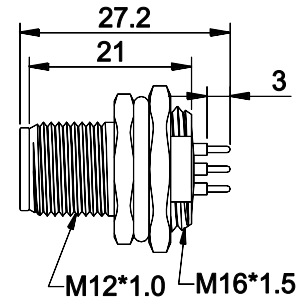

Contact layout/针孔排布 (Front view/前视图)

3pins

4pins

5pins

8pins

12pins

17pins

5pins

4pins

A

A

A

A

A

A

B

D



Order Data/订货信息

Contacts/芯数	Coding	Order No/订货号	P/N/料号
2pins	A	120102-03-004	PMM12BAM02006
3pins	A	120103-03-004	PMM12BAM03006
4pins	A	120104-03-004	PMM12BAM04006
	D	120404-03-010	PMM12BDM04008
5pins	A	120105-03-004	PMM12BAM05006
	B	120205-03-010	PMM12BBM05008
8pins	A	120108-03-004	PMM12BAM08006
12pins	A	120112-03-004	PMM12BAM12006
17pins	A	120117-03-004	PMM12BAM17006

Specifications/技术参数

Number of contacts/芯数	3	4	5	8	12	17
Termination/接线方式	PCB/插板式					
Wire gauge/线规	—					
Operating temperature/工作温度	-25°C~+85°C					
Mechanical operation/插拔次数	> 100 mating cycles					
Rated voltage/额定电压	250V		60V		30V	
Rated current (40°C)/额定电流	4A			2A		1.5A
Protection degree/防护等级	IP67/IP68					
Contact resistance/接触电阻	< 10mΩ					
Insulation resistance/绝缘电阻	≥100MΩ					
Pin contact/插针材料	CuZn					
Socket contact/插孔材料	CuSn					
Contact plating/针孔镀层材料	Au					

M12 Circular connectors

Female panel connector

Product figure (M16*1.5 rear fastened DIP)



Scale diagram

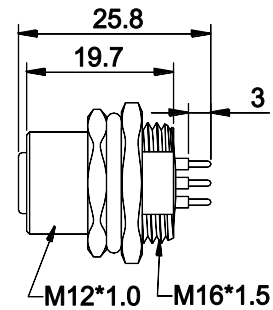

Contact layout/针孔排布 (Front view/前视图)

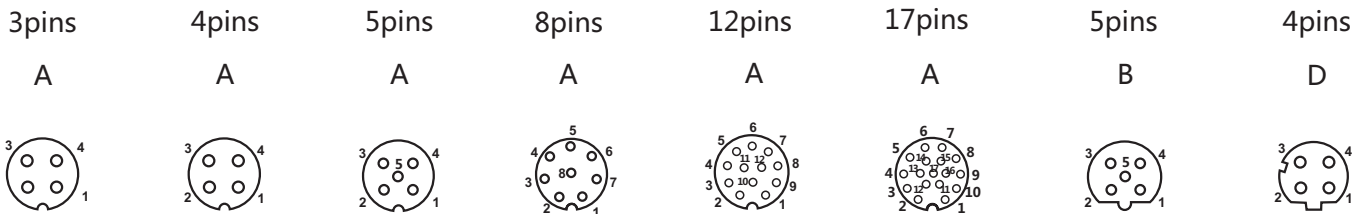

Order Data/订货信息

Contacts/芯数	Coding	Order No/订货号	P/N/料号
2pins	A	120102-04-004	PMM12BAF02006
3pins	A	120103-04-004	PMM12BAF03006
4pins	A	120104-04-004	PMM12BAF04006
	D	120404-04-012	PMM12BDF04010
5pins	A	120105-04-004	PMM12BAF05006
	B	120205-04-007	PMM12BBF05007
8pins	A	120108-04-004	PMM12BAF08006
12pins	A	120112-04-004	PMM12BAF12006
17pins	A	120117-04-004	PMM12BAF17006

Specifications/技术参数

Number of contacts/芯数	3	4	5	8	12	17
Termination/接线方式	PCB/插板式					
Wire gauge/线规	—					
Operating temperature/工作温度	-25°C ~ +85°C					
Mechanical operation/插拔次数	> 100 mating cycles					
Rated voltage/额定电压	250V		60V		30V	
Rated current (40°C)/额定电流	4A			2A		1.5A
Protection degree/防护等级	IP67/IP68					
Contact resistance/接触电阻	< 10mΩ					
Insulation resistance/绝缘电阻	≥ 100MΩ					
Pin contact/插针材料	CuZn					
Socket contact/插孔材料	CuSn					
Contact plating/针孔镀层材料	Au					

M12 Circular connectors

Male panel connector

Product figure (PG9 rear fastened DIP)

Scale diagram

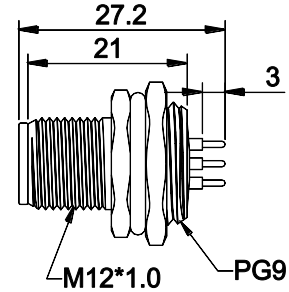

Contact layout/针孔排布 (Front view/前视图)

3pins

4pins

5pins

8pins

12pins

17pins

5pins

4pins

A

A

A

A

A

A

B

D



Order Data/订货信息

Contacts/芯数	Coding	Order No/订货号	P/N/料号
2pins	A	120102-03-005	PMM12BAM02007
3pins	A	120103-03-005	PMM12BAM03007
4pins	A	120104-03-005	PMM12BAM04007
	D	120404-03-011	PMM12BDM04009
5pins	A	120105-03-005	PMM12BAM05007
	B	120205-03-011	PMM12BBM05009
8pins	A	120108-03-005	PMM12BAM08007
12pins	A	120112-03-005	PMM12BAM12007
17pins	A	120117-03-005	PMM12BAM17007

Specifications/技术参数

Number of contacts/芯数	3	4	5	8	12	17
Termination/接线方式	PCB/插板式					
Wire gauge/线规	—					
Operating temperature/工作温度	-25°C~+85°C					
Mechanical operation/插拔次数	> 100 mating cycles					
Rated voltage/额定电压	250V		60V		30V	
Rated current (40°C)/额定电流	4A			2A		1.5A
Protection degree/防护等级	IP67/IP68					
Contact resistance/接触电阻	< 10mΩ					
Insulation resistance/绝缘电阻	≥100MΩ					
Pin contact/插针材料	CuZn					
Socket contact/插孔材料	CuSn					
Contact plating/针孔镀层材料	Au					

M12 Circular connectors

Female panel connector

Product figure (PG9 rear fastened DIP)



Scale diagram

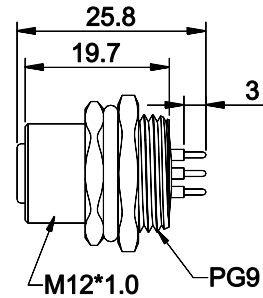

Contact layout/针孔排布 (Front view/前视图)

3pins

A



4pins

A



5pins

A



8pins

A



12pins

A



17pins

A



5pins

B



4pins

D



Order Data/订货信息

Contacts/芯数	Coding	Order No/订货号	P/N/料号
2pins	A	120102-04-005	PMM12BAF02007
3pins	A	120103-04-005	PMM12BAF03007
4pins	A	120104-04-005	PMM12BAF04007
	D	120404-04-013	PMM12BDF04011
5pins	A	120105-04-005	PMM12BAF05007
	B	120205-04-008	PMM12BBF05008
8pins	A	120108-04-005	PMM12BAF08007
12pins	A	120112-04-005	PMM12BAF12007
17pins	A	120117-04-005	PMM12BAF17007

Specifications/技术参数

Number of contacts/芯数	3	4	5	8	12	17
Termination/接线方式	PCB/插板式					
Wire gauge/线规	—					
Operating temperature/工作温度	-25°C~+85°C					
Mechanical operation/插拔次数	> 100 mating cycles					
Rated voltage/额定电压	250V		60V		30V	
Rated current (40°C)/额定电流	4A			2A		1.5A
Protection degree/防护等级	IP67/IP68					
Contact resistance/接触电阻	< 10mΩ					
Insulation resistance/绝缘电阻	≥100MΩ					
Pin contact/插针材料	CuZn					
Socket contact/插孔材料	CuSn					
Contact plating/针孔镀层材料	Au					

M12 Circular connectors

Male panel connector

Product figure (M12*1.0 rear fastened DIP)

Scale diagram

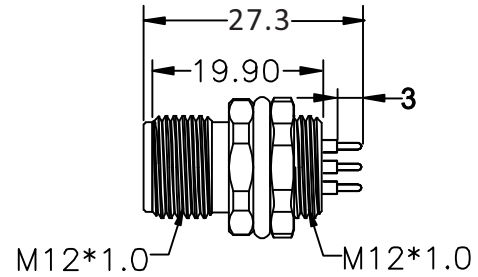

Contact layout/针孔排布 (Front view/前视图)

3pins

4pins

5pins

8pins

12pins

17pins

5pins

4pins

A

A

A

A

A

A

B

D



Order Data/订货信息

Contacts/芯数	Coding	Order No/订货号	P/N/料号
2pins	A	120102-03-020	PMM12BAM02018
3pins	A	120103-03-022	PMM12BAM03018
4pins	A	120104-03-038	PMM12BAM04020
	D	120404-03-023	PMM12BDM04021
5pins	A	120105-03-034	PMM12BAM05020
	B	120205-03-020	PMM12BBM05018
8pins	A	120108-03-040	PMM12BAM08019
12pins	A	120112-03-026	PMM12BAM12020
17pins	A	120117-03-020	PMM12BAM17018

Specifications/技术参数

Number of contacts/芯数	3	4	5	8	12	17
Termination/接线方式	PCB/插板式					
Wire gauge/线规	—					
Operating temperature/工作温度	-25°C~+85°C					
Mechanical operation/插拔次数	> 100 mating cycles					
Rated voltage/额定电压	250V		60V		30V	
Rated current (40°C)/额定电流	4A			2A		1.5A
Protection degree/防护等级	IP67/IP68					
Contact resistance/接触电阻	< 10mΩ					
Insulation resistance/绝缘电阻	≥100MΩ					
Pin contact/插针材料	CuZn					
Socket contact/插孔材料	CuSn					
Contact plating/针孔镀层材料	Au					

M12 Circular connectors

Male panel connector

Product figure (M16*1.5 front fastened DIP)



Scale diagram

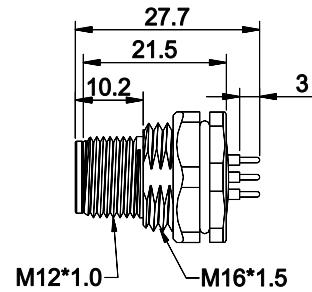

Contact layout/针孔排布 (Front view/前视图)

3pins

A



4pins

A



5pins

A



8pins

A



12pins

A



17pins

A



5pins

B



4pins

D



Order Data/订货信息

Contacts/芯数	Coding	Order No/订货号	P/N/料号
2pins	A	120102-03-008	PMM12FAM02008
3pins	A	120103-03-008	PMM12FAM03008
4pins	A	120104-03-008	PMM12FAM04008
	D	120404-03-012	PMM12FDM04008
5pins	A	120105-03-007	PMM12FAM05008
	B	120205-03-012	PMM12FBM05008
8pins	A	120108-03-008	PMM12FAM08008
12pins	A	120112-03-008	PMM12FAM12008
17pins	A	120117-03-008	PMM12FAM17008

Specifications/技术参数

Number of contacts/芯数	3	4	5	8	12	17
Termination/接线方式	PCB/插板式					
Wire gauge/线规	—					
Operating temperature/工作温度	-25°C~+85°C					
Mechanical operation/插拔次数	> 100 mating cycles					
Rated voltage/额定电压	250V		60V		30V	
Rated current (40°C)/额定电流	4A			2A		1.5A
Protection degree/防护等级	IP67/IP68					
Contact resistance/接触电阻	< 10mΩ					
Insulation resistance/绝缘电阻	≥100MΩ					
Pin contact/插针材料	CuZn					
Socket contact/插孔材料	CuSn					
Contact plating/针孔镀层材料	Au					

M12 Circular connectors

Female panel connector

Product figure (M16*1.5 front fastened DIP)

Scale diagram

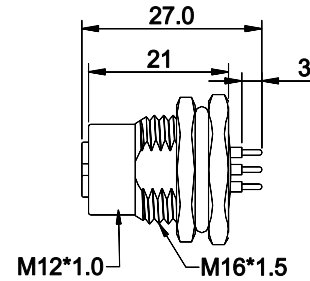

Contact layout/针孔排布 (Front view/前视图)

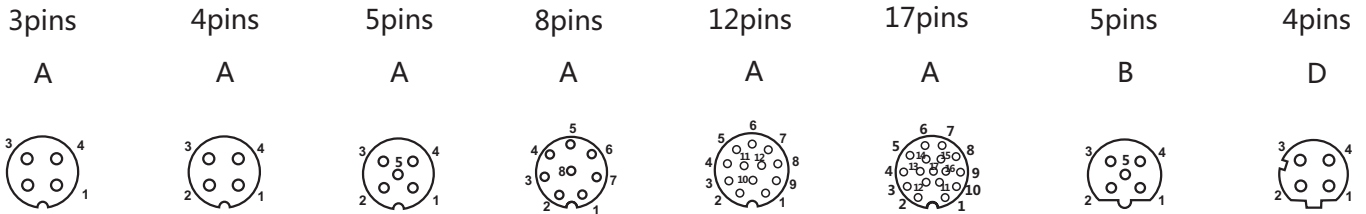

Order Data/订货信息

Contacts/芯数	Coding	Order No/订货号	P/N/料号
2pins	A	120102-04-008	PMM12FAF02008
3pins	A	120103-04-008	PMM12FAF03008
4pins	A	120104-04-008	PMM12FAF04008
	D	120404-04-014	PMM12FDF04008
5pins	A	120105-04-008	PMM12FAF05008
	B	120205-04-009	PMM12FBF05008
8pins	A	120108-04-008	PMM12FAF08008
12pins	A	120112-04-008	PMM12FAF12008
17pins	A	120117-04-008	PMM12FAF17008

Specifications/技术参数

Number of contacts/芯数	3	4	5	8	12	17
Termination/接线方式	PCB/插板式					
Wire gauge/线规	—					
Operating temperature/工作温度	-25°C~+85°C					
Mechanical operation/插拔次数	> 100 mating cycles					
Rated voltage/额定电压	250V		60V		30V	
Rated current (40°C)/额定电流	4A			2A		1.5A
Protection degree/防护等级	IP67/IP68					
Contact resistance/接触电阻	< 10mΩ					
Insulation resistance/绝缘电阻	≥100MΩ					
Pin contact/插针材料	CuZn					
Socket contact/插孔材料	CuSn					
Contact plating/针孔镀层材料	Au					

M12 Circular connectors

Male panel connector

Product figure (PG9 front fastened DIP)



Scale diagram

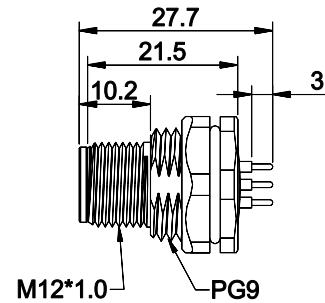

Contact layout/针孔排布 (Front view/前视图)

3pins

A



4pins

A



5pins

A



8pins

A



12pins

A



17pins

A



5pins

B



4pins

D



Order Data/订货信息

Contacts/芯数	Coding	Order No/订货号	P/N/料号
2pins	A	120102-03-009	PMM12FAM02009
3pins	A	120103-03-009	PMM12FAM03009
4pins	A	120104-03-009	PMM12FAM04009
	D	120404-03-013	PMM12FDM04009
5pins	A	120105-03-008	PMM12FAM05009
	B	120205-03-013	PMM12FBM05009
8pins	A	120108-03-009	PMM12FAM08009
12pins	A	120112-03-009	PMM12FAM12009
17pins	A	120117-03-009	PMM12FAM17009

Specifications/技术参数

Number of contacts/芯数	3	4	5	8	12	17
Termination/接线方式	PCB/插板式					
Wire gauge/线规	—					
Operating temperature/工作温度	-25°C~+85°C					
Mechanical operation/插拔次数	> 100 mating cycles					
Rated voltage/额定电压	250V		60V		30V	
Rated current (40°C)/额定电流	4A			2A		1.5A
Protection degree/防护等级	IP67/IP68					
Contact resistance/接触电阻	< 10mΩ					
Insulation resistance/绝缘电阻	≥100MΩ					
Pin contact/插针材料	CuZn					
Socket contact/插孔材料	CuSn					
Contact plating/针孔镀层材料	Au					

M12 Circular connectors

Female panel connector

Product figure (PG9 front fastened DIP)

Scale diagram

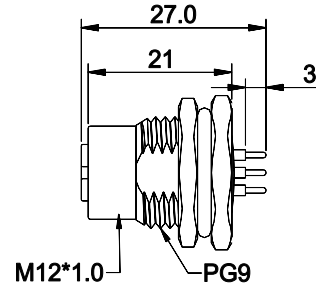

Contact layout/针孔排布 (Front view/前视图)

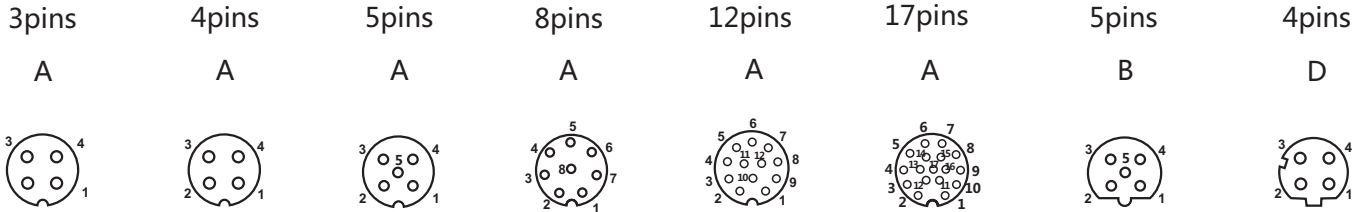

Order Data/订货信息

Contacts/芯数	Coding	Order No/订货号	P/N/料号
2pins	A	120102-04-009	PMM12FAF02009
3pins	A	120103-04-009	PMM12FAF03009
4pins	A	120104-04-009	PMM12FAF04009
	D	120404-04-015	PMM12FDF04009
5pins	A	120105-04-009	PMM12FAF05009
	B	120205-04-010	PMM12FBF05010
8pins	A	120108-04-009	PMM12FAF08009
12pins	A	120112-04-009	PMM12FAF12009
17pins	A	120117-04-009	PMM12FAF17009

Specifications/技术参数

Number of contacts/芯数	3	4	5	8	12	17
Termination/接线方式	PCB/插板式					
Wire gauge/线规	—					
Operating temperature/工作温度	-25°C~+85°C					
Mechanical operation/插拔次数	> 100 mating cycles					
Rated voltage/额定电压	250V		60V		30V	
Rated current (40°C)/额定电流	4A			2A		1.5A
Protection degree/防护等级	IP67/IP68					
Contact resistance/接触电阻	< 10mΩ					
Insulation resistance/绝缘电阻	≥100MΩ					
Pin contact/插针材料	CuZn					
Socket contact/插孔材料	CuSn					
Contact plating/针孔镀层材料	Au					

M12 Circular connectors

Male panel connector

Product figure (M12*1.0 front fastened DIP)



Scale diagram

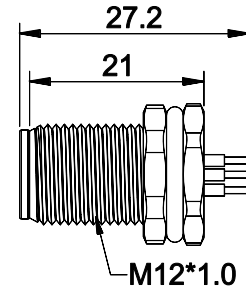

Contact layout/针孔排布 (Front view/前视图)

3pins

A



4pins

A



5pins

A



8pins

A



12pins

A



17pins

A



5pins

B



4pins

D



Order Data/订货信息

Contacts/芯数	Coding	Order No/订货号	P/N/料号
2pins	A	120102-03-012	PMM12FAM02012
3pins	A	120103-03-012	PMM12FAM03012
4pins	A	120104-03-012	PMM12FAM04012
	D	120404-03-014	PMM12FDM04012
5pins	A	120105-03-011	PMM12FAM05012
	B	120205-03-014	PMM12FBM05012
8pins	A	120108-03-012	PMM12FAM08012
12pins	A	120112-03-012	PMM12FAM12012
17pins	A	120117-03-012	PMM12FAM17012

Specifications/技术参数

Number of contacts/芯数	3	4	5	8	12	17
Termination/接线方式	PCB/插板式					
Wire gauge/线规	—					
Operating temperature/工作温度	-25°C~+85°C					
Mechanical operation/插拔次数	> 100 mating cycles					
Rated voltage/额定电压	250V		60V		30V	
Rated current (40°C)/额定电流	4A			2A		1.5A
Protection degree/防护等级	IP67/IP68					
Contact resistance/接触电阻	< 10mΩ					
Insulation resistance/绝缘电阻	≥100MΩ					
Pin contact/插针材料	CuZn					
Socket contact/插孔材料	CuSn					
Contact plating/针孔镀层材料	Au					

M12 Circular connectors

Male panel connector

Product figure(M12*1.0 front fastened DIP with ground)



Scale diagram

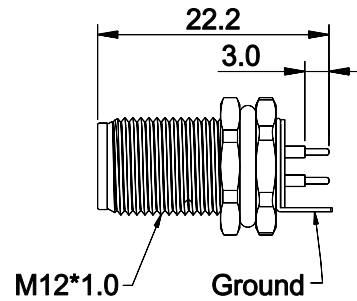

Contact layout/针孔排布 (Front view/前视图)

3pins

4pins

5pins

8pins

12pins

17pins

5pins

4pins

A

A

A

A

A

A

B

D



Order Data/订货信息

Contacts/芯数	Coding	Order No/订货号	P/N/料号
2pins	A	120102-03-013	PMM12FAM02013
3pins	A	120103-03-013	PMM12FAM03013
4pins	A	120104-03-013	PMM12FAM04013
	D	120404-03-015	PMM12FDM04013
5pins	A	120105-03-012	PMM12FAM05013
	B	120205-03-015	PMM12FBM05013
8pins	A	120108-03-013	PMM12FAM08013
12pins	A	120112-03-013	PMM12FAM12013
17pins	A	120117-03-013	PMM12FAM17013

Specifications/技术参数

Number of contacts/芯数	3	4	5	8	12	17
Termination/接线方式	PCB/插板式					
Wire gauge/线规	—					
Operating temperature/工作温度	-25°C~+85°C					
Mechanical operation/插拔次数	> 100 mating cycles					
Rated voltage/额定电压	250V		60V		30V	
Rated current (40°C)/额定电流	4A			2A		1.5A
Protection degree/防护等级	IP67/IP68					
Contact resistance/接触电阻	< 10mΩ					
Insulation resistance/绝缘电阻	≥100MΩ					
Pin contact/插针材料	CuZn					
Socket contact/插孔材料	CuSn					
Contact plating/针孔镀层材料	Au					

Male panel connector

Product figure (M12*1.0 front fastened DIP)



Scale diagram

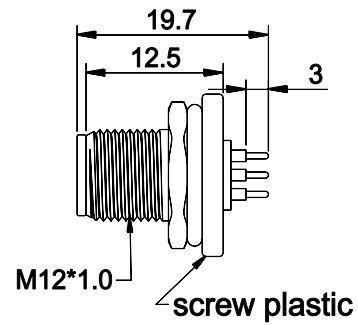

Contact layout/针孔排布 (Front view/前视图)

3pins

A



4pins

A



5pins

A



8pins

A



12pins

A



5pins

B



4pins

D



Order Data/订货信息

Contacts/芯数	Coding	Order No/订货号	P/N/料号
2pins	A	120102-03-015	PMM12FAM02015
3pins	A	120103-03-015	PMM12FAM03015
4pins	A	120104-03-015	PMM12FAM04015
	D	120404-03-017	PMM12FDM04015
5pins	A	120105-03-014	PMM12FAM05015
	B	120205-03-017	PMM12FBM05015
8pins	A	120108-03-015	PMM12FAM08015
12pins	A	120112-03-015	PMM12FAM12015

Specifications/技术参数

Number of contacts/芯数	3	4	5	8	12	17
Termination/接线方式	PCB/插板式					
Wire gauge/线规	—					
Operating temperature/工作温度	-25°C~+85°C					
Mechanical operation/插拔次数	> 100 mating cycles					
Rated voltage/额定电压	250V		60V		30V	
Rated current (40°C)/额定电流	4A			2A		1.5A
Protection degree/防护等级	IP67/IP68					
Contact resistance/接触电阻	< 10mΩ					
Insulation resistance/绝缘电阻	≥100MΩ					
Pin contact/插针材料	CuZn					
Socket contact/插孔材料	CuSn					
Contact plating/针孔镀层材料	Au					

M12 Circular connectors

Male panel connector

Product figure(M16*1.5 front fastened DIP)

Scale diagram

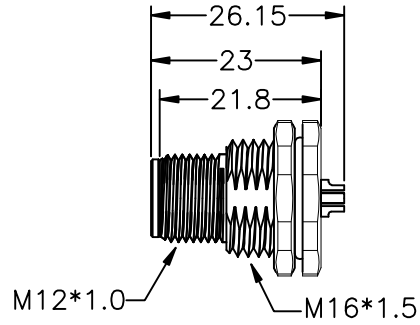

Contact layout/针孔排布 (Front view/前视图)

5pins

A



Order Data/订货信息

Contacts/芯数	Coding	Order No/订货号	P/N/料号
5pins	A	120105-03-078	—

Specifications/技术参数

Number of contacts/芯数	5
Termination/接线方式	solder/焊接
Wire gauge/线规	—
Operating temperature/工作温度	-25°C~+85°C
Mechanical operation/插拔次数	> 100 mating cycles
Rated voltage/额定电压	60V
Rated current (40°C)/额定电流	4A
Protection degree/防护等级	IP67/IP68
Contact resistance/接触电阻	≤5mΩ
Insulation resistance/绝缘电阻	≥100MΩ
Pin contact/插针材料	CuZn
Socket contact/插孔材料	CuSn
Contact plating/针孔镀层材料	Au

Female panel connector

Product figure (M16*1.5 front fastened DIP)



Scale diagram

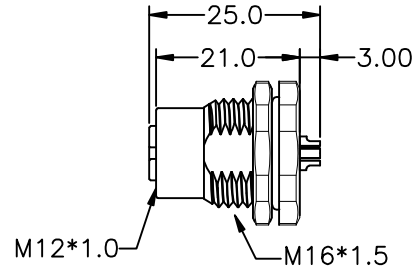

Contact layout/针孔排布 (Front view/前视图)

5pins

A



Order Data/订货信息

Contacts/芯数	Coding	Order No/订货号	P/N/料号
5pins	A	120105-04-053	—

Specifications/技术参数

Number of contacts/芯数	5
Termination/接线方式	solder/焊接
Wire gauge/线规	—
Operating temperature/工作温度	-25°C~+85°C
Mechanical operation/插拔次数	> 100 mating cycles
Rated voltage/额定电压	60V
Rated current (40°C)/额定电流	4A
Protection degree/防护等级	IP67/IP68
Contact resistance/接触电阻	≤5mΩ
Insulation resistance/绝缘电阻	≥100MΩ
Pin contact/插针材料	CuZn
Socket contact/插孔材料	CuSn
Contact plating/针孔镀层材料	Au

M12 Circular connectors

Female panel connector

Product figure (M12*1.5 front fastened DIP with location)



Scale diagram

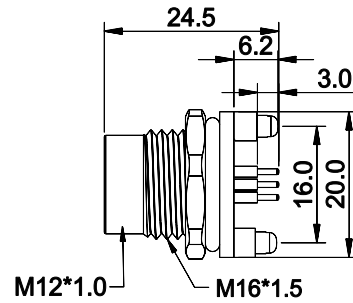

Contact layout/针孔排布 (Front view/前视图)

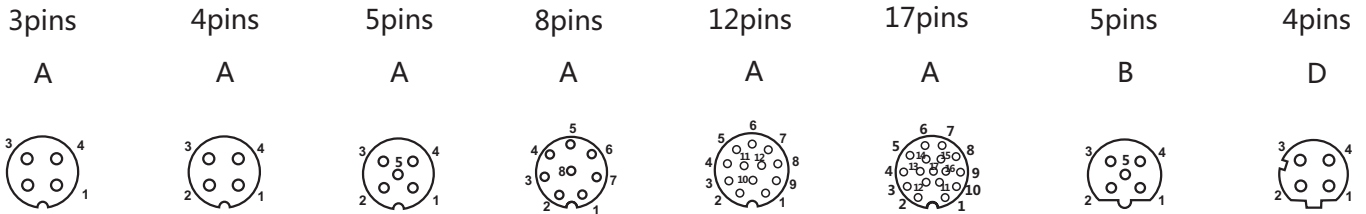

Order Data/订货信息

Contacts/芯数	Coding	Order No/订货号	P/N/料号
2pins	A	120102-04-010	PMM12FAF02010
3pins	A	120103-04-010	PMM12FAF03010
4pins	A	120104-04-010	PMM12FAF04010
	D	120404-04-016	PMM12FDF04014
5pins	A	120105-04-010	PMM12FAF05010
	B	120205-04-011	PMM12FBF05011
8pins	A	120108-04-010	PMM12FAF08010
12pins	A	120112-04-010	PMM12FAF12010
17pins	A	120117-04-010	PMM12FAF17010

Specifications/技术参数

Number of contacts/芯数	3	4	5	8	12	17
Termination/接线方式	PCB/插板式					
Wire gauge/线规	—					
Operating temperature/工作温度	-25°C~+85°C					
Mechanical operation/插拔次数	> 100 mating cycles					
Rated voltage/额定电压	250V		60V		30V	
Rated current (40°C)/额定电流	4A			2A		1.5A
Protection degree/防护等级	IP67/IP68					
Contact resistance/接触电阻	< 10mΩ					
Insulation resistance/绝缘电阻	≥100MΩ					
Pin contact/插针材料	CuZn					
Socket contact/插孔材料	CuSn					
Contact plating/针孔镀层材料	Au					

M12 Circular connectors

Male panel connector

Product figure (M12*1.0 front fastened DIP with location)



Scale diagram

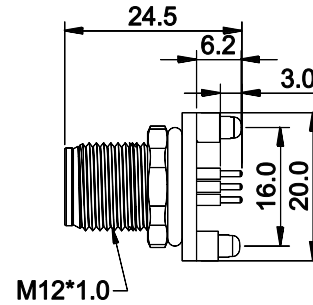

Contact layout/针孔排布 (Front view/前视图)

3pins

A



4pins

A



5pins

A



8pins

A



12pins

A



17pins

A



5pins

B



4pins

D



Order Data/订货信息

Contacts/芯数	Coding	Order No/订货号	P/N/料号
2pins	A	120102-03-010	PMM12FAM02010
3pins	A	120103-03-010	PMM12FAM03010
4pins	A	120104-03-010	PMM12FAM04010
	D	120404-03-016	PMM12FDM04014
5pins	A	120105-03-009	PMM12FAM05010
	B	120205-03-016	PMM12FBM05014
8pins	A	120108-03-010	PMM12FAM08010
12pins	A	120112-03-010	PMM12FAM12010
17pins	A	120117-03-010	PMM12FAM17010

Specifications/技术参数

Number of contacts/芯数	3	4	5	8	12	17
Termination/接线方式	PCB/插板式					
Wire gauge/线规	—					
Operating temperature/工作温度	-25°C~+85°C					
Mechanical operation/插拔次数	> 100 mating cycles					
Rated voltage/额定电压	250V		60V		30V	
Rated current (40°C)/额定电流	4A			2A		1.5A
Protection degree/防护等级	IP67/IP68					
Contact resistance/接触电阻	< 10mΩ					
Insulation resistance/绝缘电阻	≥100MΩ					
Pin contact/插针材料	CuZn					
Socket contact/插孔材料	CuSn					
Contact plating/针孔镀层材料	Au					

M12 Circular connectors

Male panel connector

Product figure (M12*1.0 90° front fastened DIP)

Scale diagram

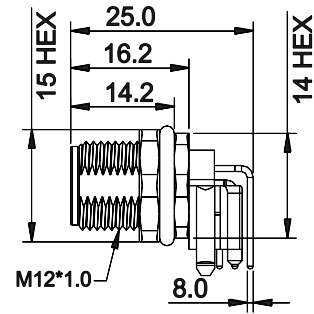

Contact layout/针孔排布 (Front view/前视图)

3pins

4pins

5pins

8pins

12pins

A

A

A

A

A

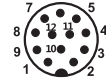

Order Data/订货信息

Contacts/芯数	Coding	Order No/订货号	P/N/料号
2pins	A	120102-03-016	PMM12FAM02016
3pins	A	120103-03-016	PMM12FAM03016
4pins	A	120104-03-016	PMM12FAM04016
5pins	A	120105-03-015	PMM12FAM05016
8pins	A	120108-03-016	PMM12FAM08016
12pins	A	120112-03-016	PMM12FAM12016

Specifications/技术参数

Number of contacts/芯数	3	4	5	8	12
Termination/接线方式	PCB/插板式				
Wire gauge/线规	—				
Operating temperature/工作温度	-25°C ~ +85°C				
Mechanical operation/插拔次数	> 100 mating cycles				
Rated voltage/额定电压	250V		60V	30V	
Rated current (40°C)/额定电流	4A			2A	1.5A
Protection degree/防护等级	IP67/IP68				
Contact resistance/接触电阻	< 10mΩ				
Insulation resistance/绝缘电阻	≥ 100MΩ				
Pin contact/插针材料	CuZn				
Socket contact/插孔材料	CuSn				
Contact plating/针孔镀层材料	Au				

Female panel connector

Product figure (M12*1.0 90° front fastened DIP)

Scale diagram

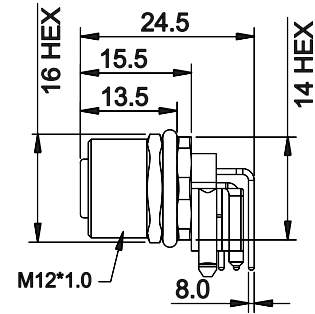

Contact layout/针孔排布 (Front view/前视图)

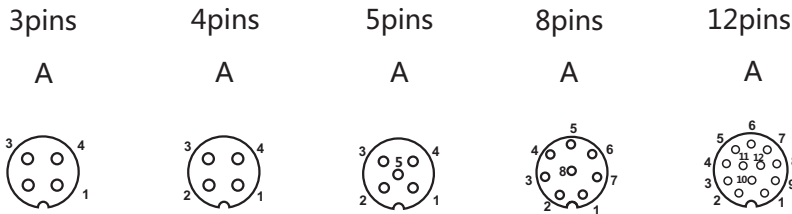

Order Data/订货信息

Contacts/芯数	Coding	Order No/订货号	P/N/料号
2pins	A	120102-04-011	PMM12FAF02011
3pins	A	120103-04-011	PMM12FAF03011
4pins	A	120104-04-011	PMM12FAF04011
5pins	A	120105-04-011	PMM12FAF05011
8pins	A	120108-04-011	PMM12FAF08011
12pins	A	120112-04-011	PMM12FAF12011

Specifications/技术参数

Number of contacts/芯数	3	4	5	8	12
Termination/接线方式	PCB/插板式				
Wire gauge/线规	—				
Operating temperature/工作温度	-25°C ~ +85°C				
Mechanical operation/插拔次数	> 100 mating cycles				
Rated voltage/额定电压	250V		60V	30V	
Rated current (40°C)/额定电流	4A			2A	1.5A
Protection degree/防护等级	IP67/IP68				
Contact resistance/接触电阻	< 10mΩ				
Insulation resistance/绝缘电阻	≥ 100MΩ				
Pin contact/插针材料	CuZn				
Socket contact/插孔材料	CuSn				
Contact plating/针孔镀层材料	Au				

M12 Circular connectors

Female panel connector

Product figure (M12*1.0 90° front fastened DIP)



Scale diagram

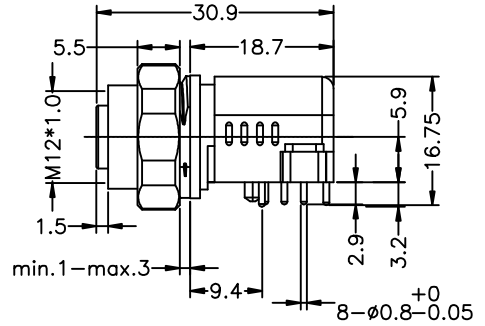

Contact layout/针孔排布 (Front view/前视图)

4pins

D



Order Data/订货信息

Contacts/芯数	Coding	Order No/订货号	P/N/料号
4pins	D	120404-04-065	—

Specifications/技术参数

Number of contacts/芯数	4
Termination/接线方式	PCB/插板式
Wire gauge/线规	—
Operating temperature/工作温度	-25°C~+85°C
Mechanical operation/插拔次数	> 100 mating cycles
Rated voltage/额定电压	250V
Rated current (40°C)/额定电流	4A
Protection degree/防护等级	IP67/IP68
Contact resistance/接触电阻	< 10m Ω
Insulation resistance/绝缘电阻	\geq 100M Ω
Pin contact/插针材料	CuZn
Socket contact/插孔材料	CuSn
Contact plating/针孔镀层材料	Au