

Photoelectric Sensor with Separate Digital Amplifier (Laser-type) E3C-LDA□N



Variable Laser Beam for Spot, Line, or Area Detection

- Long-distance detection (diffuse reflective: 1 m, retro-reflective: 7 m).
- Beam shape selectable from spot, line, and area types to match various applications.
- Adjustable spot diameter.
- Adjustable optical axis.



Refer to *Safety Precautions* on page 8.

For the most recent information on models that have been certified for safety standards, refer to your OMRON website.

Features

Diffuse Reflective Model

■ Provide ample long-distance detection of 1,000 mm.

Sensing distance of 1 m.

Three beam types means a wider variety of applications.

■ Spot, Line, and Area Types

Suitable for various applications.

Mount Beam Units to a Spot Type Sensor to convert to Line or Area Type.

Spot Type
E3C-LD11N

Line Type
E3C-LD11N
+ E39-P11

Area Type
E3C-LD11N
+ E39-P21

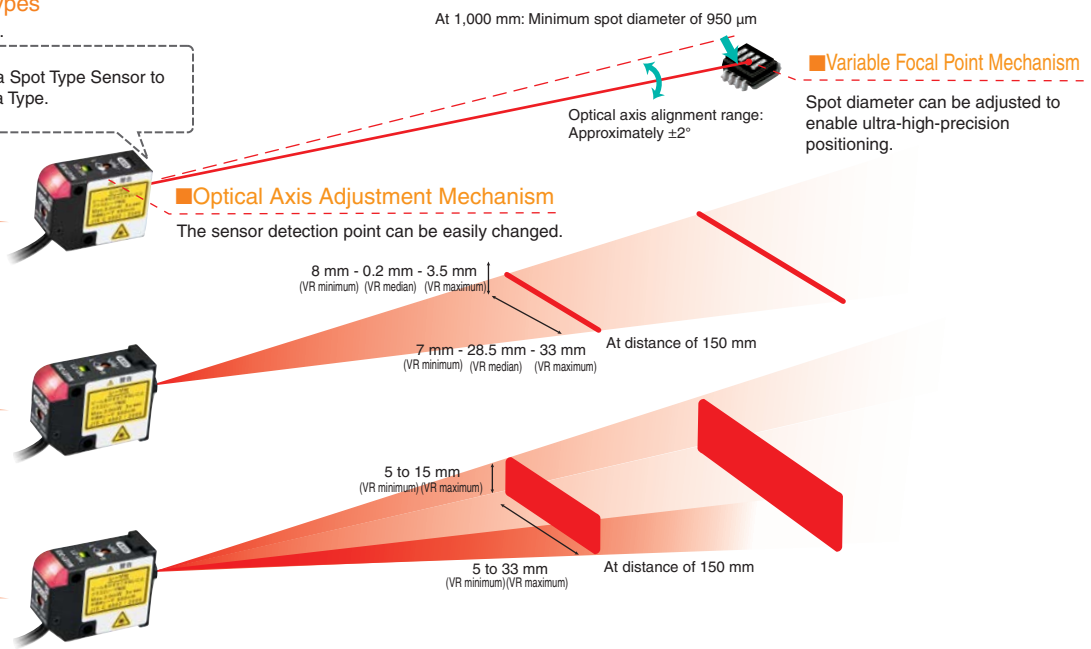

Coaxial Retroreflective Model

■ Easy Sensor Installation and Sensing Characteristics Equivalent to Through-beam Sensors.

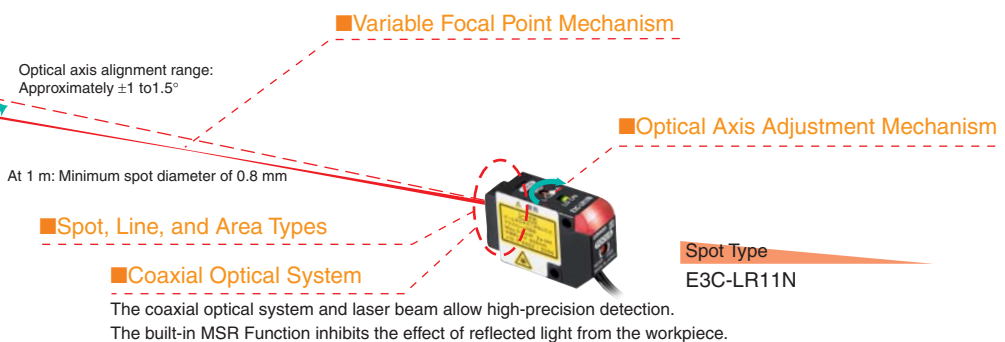

Sensing distance of 7 m.



E3C-LDA□N

Ordering Information



Sensor Heads (Dimensions → page 14)

Sensing method	Appearance	Beam shape	Sensing distance	Laser Class	Model
Diffuse-reflective		Spot *2 (variable)	1 m	Class 2	E3C-LD11N 2M
Coaxial Retro-reflective (with MSR function) *1		Spot *2 (variable)	7 m	Class 2	E3C-LR11N 2M
		Spot (2.0-mm fixed dia.)	7 m	Class 1	E3C-LR12N 2M

*1. Select a Reflector (order separately) according to the application.

*2. Mounting a Beam Unit (sold separately) allows the use of line and area beams. or Area beam type.



Amplifier Units (Dimensions → page 16, 17)

Connection method	Appearance	Inputs/outputs	Model	
			NPN output	PNP output
Pre-wired Amplifier Units		2 outputs + 1 input	E3C-LDA21N 2M	E3C-LDA51N 2M
Amplifier Units with Wire-saving Connectors		2 outputs	E3C-LDA6N	E3C-LDA8N
		1 output + 1 input	E3C-LDA7N	E3C-LDA9N

Accessories (Order Separately)



Wire-saving connectors (Required for models for Wire-saving Connectors.)

*Protective stickers: provided. (Dimensions → P.18)

Item	Appearance	Cable length	No. of conductors	Model
Master Connector		2 m	4	E3X-CN21
Slave Connector			2	E3X-CN22

Beam Unit (for E3C-LD11N/LR11N)

A Beam Unit is not provided with the Sensor and must be ordered separately as required.

Applicable Sensor Head	Appearance	Beam shape	Model
E3C-LD11N		Line	E39-P11
		Area	E39-P21
E3C-LR11N		Line	E39-P31
		Area	E39-P41

Mounting Bracket

A Mounting Bracket is not provided with the Amplifier Unit and must be ordered separately as required.

Appearance	Model	Quantity
	E39-L143	1

Note: Refer to E39-L/-S/-R on your OMRON website for details.

End Plate



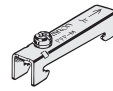

A End Plate is not provided with the Amplifier Unit and must be ordered separately as required.

Appearance	Model	Quantity
	PFP-M	1

Note: Refer to PFP-□N/-M/-S on your OMRON website for details.

Reflectors (Required when using retro-reflective models)

A Reflector is not provided with the Sensor head. Be sure to order a Reflector separately.

Type	Appearance	Model
Standard Effective area: 23 × 23 mm *		E39-R12
Standard Effective area: 7 × 7 mm *		E39-R13
Transparent object detection Effective area: 23 × 23 mm *		E39-R14
Sheet (cuttable) Effective area: 195 × 22 mm		E39-RS4
Sheet (cuttable) Effective area: 108 × 46 mm		E39-RS5

Note: Refer to E39-L/-S/-R on your OMRON website for details.

* Use a standard model (E39-R12/R13) if the distance from the Sensor is 400 mm or more. Use the short-distance model (E39-R14) if the distance is less than 400 mm.

Ratings and Specifications

Sensor Heads

Type Model		Diffuse-reflective			Coaxial Retro-reflective (with MSR function)			
		E3C-LD11N	E3C-LD11N + E39-P11	E3C-LD11N + E39-P21	E3C-LR11N	E3C-LR11N + E39-P31	E3C-LR11N + E39-P41	E3C-LR12N
Light source (wavelength)		Red semiconductor laser diode (650 nm), 3 mW max. (JIS Class 2, IEC/EN Class 2, and FDA Class 2)			Red semiconductor laser diode (650 nm), 3 mW max. (JIS Class 2, IEC/EN Class 2, and FDA Class 2)			1 mW max. (JIS Class 1, IEC/EN Class 1, and FDA Class 2)
Sensing distance *1, *2	Super High- speed Mode (SHS)	30 to 250 mm			2 m	700 mm	400 mm	2 m
	High-speed Mode (HS)	30 to 250 mm			2 m	700 mm	400 mm	2 m
	Standard Mode (Std)	30 to 700 mm			5 m	1,300 mm	700 mm	5 m
	Giga Mode (GIGA)	30 to 1000 mm			7 m	1,700 mm	900 mm	7 m
Focus *3		0.8 mm max. (at distances up to 300 mm)	33 mm (at 150 mm)	33 × 15 mm (at 150 mm)	0.8 mm max. (at distances up to 1,000 mm)	28 mm (at 150 mm)	28 × 16 mm (at 150 mm)	2.0-mm dia. (at distance up to 1,000 mm)
Functions		Variable focal point mechanism (focus adjustment) *4, optical axis adjustment mechanism (axis adjustment)						
Indicators		LDON indicator: Green; Operation indicator: Orange						
Ambient illumination (Receiver side)		Incandescent lamp: 3,000 lx						
Ambient temperature		Operating: -10 to 55°C, Storage: -25 to 70°C (with no icing or condensation)						
Ambient humidity		Operating/storage: 35% to 85% (with no condensation)						
Insulation resistance		20 MΩ min. at 500 VDC						
Dielectric strength		1,000 VAC at 50/60 Hz for 1 minute						
Shock resistance		Destruction: 300 m/s ² 6 directions 3 times each (up/down, right/left, forward/backward)						
Vibration resistance		Destruction: 10 to 150 Hz with double amplitude of 0.7 mm, in X, Y, and Z directions for 80 min each						
Degree of protection		IP40 (IEC)			IP40 (IEC 60529)			
Connection method		Connector (standard cable length: 2 m)						
Materials		Case and cover: ABS Front surface filter: Methacrylic resin			Case and cover: ABS Front surface filter: Glass			
Weight (packed state)		Approx. 85 g			Approx. 100 g			
Accessories		Instruction manual, Laser warning labels (English)						

*1. The sensing distance of E3C-LD11N is the value of the white paper.

*2. The sensing distance of E3C-LR□□N is values apply when a E39-R12 Reflector is used.

*3. The beam radius is the value for the middle measurement distance and indicates a typical value for the middle sensing distance. The radius is defined by light intensity of 1/e² (13.5%) of the central light intensity.

Light will extend beyond the main beam and may be affected by conditions surrounding the object being measured.

*4. The E3C-LR12N has a fixed beam size (the focal point cannot be changed).

Amplifier Units

Model	NPN output	E3C-LDA21N	E3C-LDA6N	E3C-LDA7N
	PNP output	E3C-LDA51N	E3C-LDA8N	E3C-LDA9N
	Connection method *2	Pre-wired		Wire-saving Connector
Applicable Amplifier Unit		E3C-L□□□N		
Outputs		2 outputs	2 outputs	1 output
External input *1		1 input	---	1 input
Supply voltage		12 to 24 VDC ±10%, ripple (p-p) 10% max.		
Power consumption		Power consumption: 1080 mW max. (when the power supply voltage is 24 V, the current consumption is 45 mA max.)		
Control output		Load power supply voltage: 26.4 VDC, open collector output type (depends on the NPN/PNP output format) Load current: 100 mA max. for 1 to 3 units use, 20 mA max. for 4 or more units joined. Residual voltage: Load current less than 10 mA: 1 V max., load current 10 to 100 mA: 2 V max. Off-state current: 0.1 mA max.		
Indicators		7-segment displays (Threshold Level display: green, Incident Light Level display: white) Display direction: Switchable between normal and reversed. OUT indicator (orange), L/D indicator (orange), ST indicator (blue), DPC indicator (green), and OUT selection indicator (orange, only on models with 2 outputs)		
Protection circuits		Power supply reverse polarity protection, output short-circuit protection, and output reverse polarity protection		
Response time	Super-high-speed mode (SHS)	Operate or reset: 80 μs		
	High-speed mode (HS)	Operate or reset: 250 μs		
	Standard mode (Std)	Operate or reset: 1 ms		
	Giga mode (GIGA)	Operate or reset: 4 ms		
Sensitivity adjustment		Smart Tuning (2-point tuning, full auto tuning, power tuning, percentage tuning) or manual adjustment		
Maximum connectable Units		16		
No. of Units for mutual interference prevention *3	Super High-speed Mode (SHS)	0 Note: The mutual interference prevention function is disabled when the detection mode is set to High Speed mode (SHS).		
	High-speed Mode (HS)	10		
	Standard Mode (Std)	10		
	Giga Mode (GIGA)	10		
Functions	Dynamic power control (DPC)	Provided		
	Timer	Select from timer disabled, OFF-delay, ON-delay or one-shot timer. 1 to 9,999 ms		
	Zero reset	Negative values can be displayed. (Threshold value is shifted.)		
	Resetting settings	Initial reset (factory defaults)		
	Power tuning	Select from ON or OFF.		
	Output 1	Select from normal detection mode or area detection mode.		
	Output 2	Select from normal detection mode, alarm output mode or error output mode.	---	
	External input	Select from input OFF, tuning, power tuning, emission OFF or zero reset.	---	Select from input OFF, tuning, power tuning, emission OFF or zero reset.
Hysteresis width	Select from standard setting or user setting.			
Ambient temperature range		Operating: Groups of 1 or 2 Amplifier Units: -25 to 55°C, Groups of 3 to 10 Amplifier Units: -25 to 50°C, Groups of 11 to 16 Amplifier Units: -25 to 45°C Storage: -30 to 70°C (with no icing or condensation)		
Ambient humidity range		Operating and storage: 35 to 85% (with no condensation) within the surrounding air temperature range shown above		
Altitude		2000 m max.		
Installation environment		Pollution degree 3 (as per IEC 60947-1)		
Insulation resistance		20 MΩ (at 500 VDC)		
Dielectric strength		1,000 VAC at 50/60 Hz for 1 min		
Vibration resistance (destruction)		10 to 55 Hz with a 1.5-mm double amplitude for 2 hours each in X, Y, and Z directions		
Shock resistance (destruction)		500 m/s ² for 3 times each in X, Y, and Z directions		
Weight (packed state/sensor only)		Approx. 115 g/approx. 75 g	Approx. 60 g/approx. 20 g	
Materials	Case	Polycarbonate (PC)		
	Protective cover	Polycarbonate (PC)		
	Cable	PVC		
Accessories		Instruction manual, compliance sheet		

*1. The following details apply to the input.

	Contact input (relay or switch)	Non-contact input (transistor)	Input time *1-1
NPN	ON: Shorted to 0 V (Sourcing current: 1 mA max.)	ON: 1.5 V max. (Sourcing current: 1 mA max.)	ON: 9 ms min. OFF: 20 ms min.
	OFF: Open or shorted to Vcc	OFF: Vcc - 1.5 V to Vcc (Leakage current: 0.1 mA max.)	
PNP	ON: Shorted to Vcc (Sinking current: 3 mA max.)	ON: Vcc - 1.5 V to Vcc (Sinking current: 3 mA max.)	
	OFF: Open or shorted to 0 V	OFF: 1.5 V max. (Leakage current: 0.1 mA max.)	

*1-1. Input time is 25 ms (ON)/(OFF) only when (in tUnE) input is selected.

*2. Separately purchase the E3X-CN21 Master Connector (4-conductor) when using this product as a single unit or as a master unit, or the E3X-CN22 Slave Connector (2-conductor) when using as a slave unit. Either Connector can be used.

*3. The tuning will not change the number of units. In standard mode and giga mode, set the threshold value to 400 or more.

Engineering Data (Reference Value)

Minimum Beam Diameter vs. Sensing Distance

E3C-LD11N

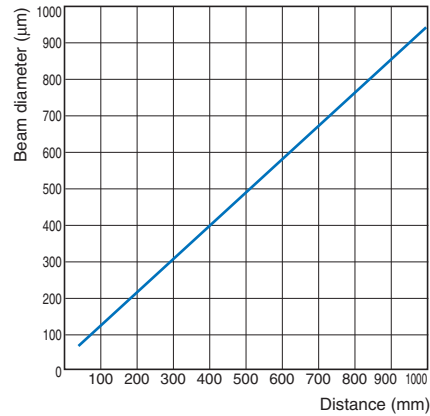

E3C-LR11N

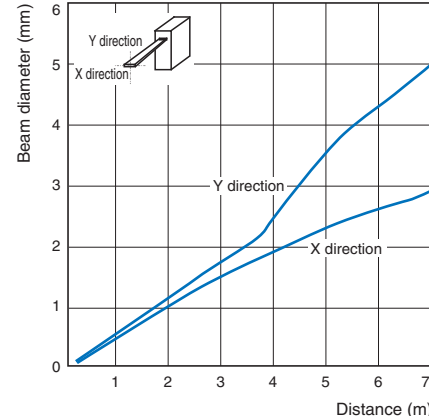

E3C-LR12N

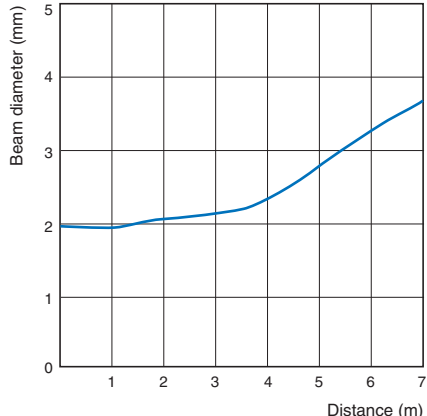

Beam Shape vs. Sensing Distance

E3C-LD11N + E39-P11

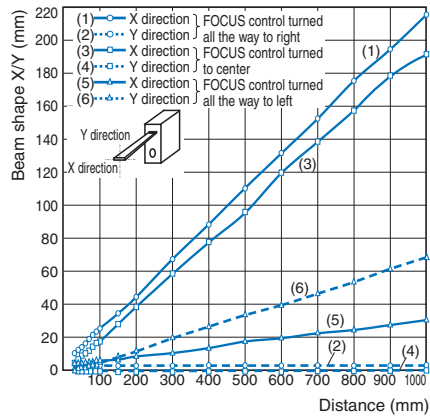

E3C-LD11N + E39-P21

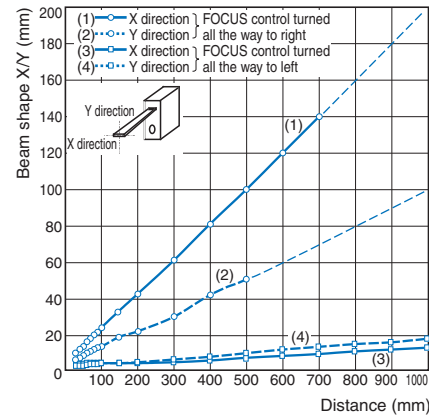

Note: The dashed lines indicate non-visible regions of the beam shape.

E3C-LDA□N

I/O Circuit Diagrams

NPN Output

Model	Operation mode	Timing chart	L/D indicator	Output circuit
E3C-LDA21N	Light-ON	<p>ch1/ Incident light </p> <p>ch2/ No incident light </p> <p>(Between brown and black (orange) leads)</p>		
	Dark-ON	<p>ch1/ Incident light </p> <p>ch2/ No incident light </p> <p>(Between brown and black (orange) leads)</p>		
E3C-LDA7N	Light-ON	<p>Incident light </p> <p>No incident light </p> <p>(Between brown and black leads)</p>		
	Dark-ON	<p>Incident light </p> <p>No incident light </p> <p>(Between brown and black leads)</p>		
E3C-LDA6N	Light-ON	<p>ch1/ Incident light </p> <p>ch2/ No incident light </p> <p>(Between brown and black (orange) leads)</p>		
	Dark-ON	<p>ch1/ Incident light </p> <p>ch2/ No incident light </p> <p>(Between brown and black (orange) leads)</p>		

PNP Output

Model	Operation mode	Timing chart	L/D indicator	Output circuit
E3C-LDA51N	Light-ON	ch1/ Incident light ch2 No incident light OUT indicator Lit (orange) Not lit Output ON transistor OFF Load Operate (e.g., relay) Reset (Between blue and black (orange) leads)	L lit.	
	Dark-ON	ch1/ Incident light ch2 No incident light OUT indicator Lit (orange) Not lit Output ON transistor OFF Load Operate (e.g., relay) Reset (Between blue and black (orange) leads)	D lit.	
E3C-LDA9N	Light-ON	Incident light No incident light OUT indicator Lit (orange) Not lit Output ON transistor OFF Load Operate (e.g., relay) Reset (Between blue and black leads)	L lit.	
	Dark-ON	Incident light No incident light OUT indicator Lit (orange) Not lit Output ON transistor OFF Load Operate (e.g., relay) Reset (Between blue and black leads)	D lit.	
E3C-LDA8N	Light-ON	ch1/ Incident light ch2 No incident light OUT indicator Lit (orange) Not lit Output ON transistor OFF Load Operate (e.g., relay) Reset (Between blue and black (orange) leads)	L lit.	
	Dark-ON	ch1/ Incident light ch2 No incident light OUT indicator Lit (orange) Not lit Output ON transistor OFF Load Operate (e.g., relay) Reset (Between blue and black (orange) leads)	D lit.	

E3C-LDA□N

Nomenclature

Amplifier Units

E3C-LDA7N/LDA9N

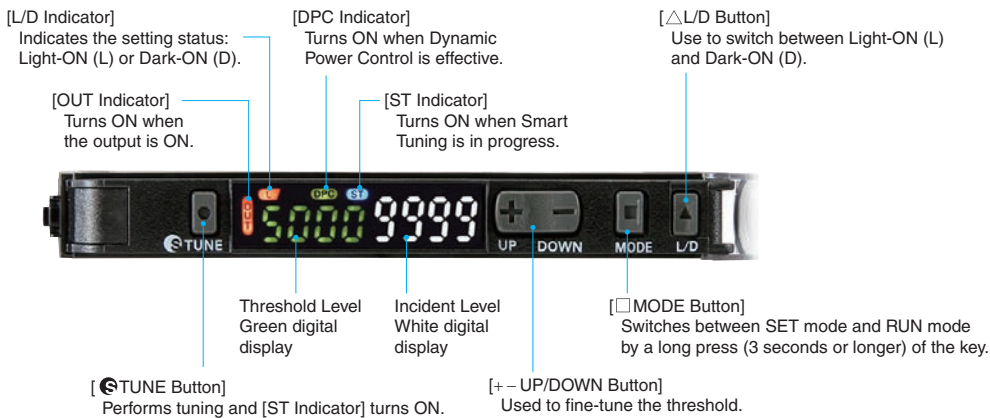

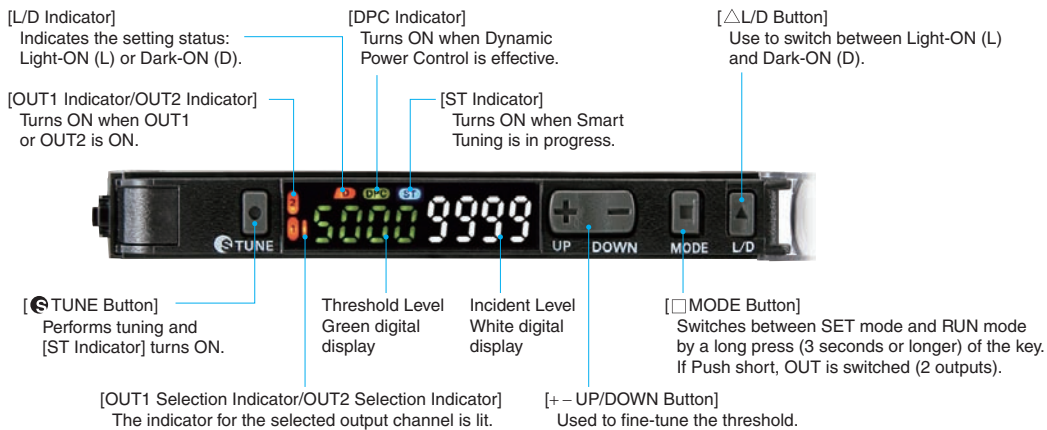

E3C-LDA21N/LDA51N/LDA6N/LDA8N







Safety Precautions

Be sure to read the precautions for all models in the website at: <http://www.ia.omron.com/>.

Warning Indications

 WARNING	Warning level Indicates a potentially hazardous situation which, if not avoided, will result in minor or moderate injury, or may result in serious injury or death. Additionally there may be significant property damage.
 CAUTION	Caution level Indicates a potentially hazardous situation which, if not avoided, may result in minor or moderate injury or in property damage.
Precautions for Safe Use	Supplementary comments on what to do or avoid doing, to use the product safely.
Precautions for Correct Use	Supplementary comments on what to do or avoid doing, to prevent failure to operate, malfunction or undesirable effect on product performance.

Meaning of Product Safety Symbols

	General prohibition Instructions on unspecified prohibited action.
	Caution, fire Indicates the possibility of fires under specific conditions.
	Caution, explosion Indicates the possibility of explosion under specific conditions.
	Caution, laser beam Indicates the possibility of the risk of laser beam exposure.
	Disassembly prohibited Prohibit the disassembly of a device because of the possibility of injuries due to electric shock.

Sensor Heads

WARNING

This product is not designed or rated for ensuring safety of persons either directly or indirectly. Do not use it for such purposes.



Do not expose your eyes to the laser radiation either directly (i.e., after reflection from a mirror or shiny surface). Loss of sight may possibly occur in case of the exposure to laser high power density. (Applicable to the E3C-LD11N/E3C-LR11N)



Do not disassemble the product. Doing so may cause the laser beam to leak, resulting in the danger of visual impairment. (Applicable to the E3C-LD11N/E3C-LR11N)



CAUTION

This Class 1 laser product as defined by JIS standards is designed to be safe. However, do not look directly at the laser light even through lenses or any other optical system normally used for observation. (Applicable to the E3C-LR12N)



Precautions for Safe Use

Please observe the following precautions for safe use of the products.

- Do not use the product in environments where it can be exposed to inflammable/explosive gas.
- To secure the safety of operation and maintenance, do not install the product close to high-voltage devices and power devices.
- Be sure to use a dedicated amplifier unit (E3C-LDA□□N). Connecting the sensor to other amplifier unit may cause damage or fire.
- When short circuiting the cable, be sure to connect wires correctly according to the specification. Improper connection may cause damage or fire.
- High-Voltage lines and power lines must be wired separately from this product. Wiring them together or placing them in the same duct may cause induction, resulting in malfunction or damage.
- Always turn off the power of the unit before connecting or disconnecting cables.
- Use screws for mounting and be sure to tighten screws with a specified torque. (tightening torque: M3, 0.5 N·m)
- Do not attempt to disassemble, repair, modify, deform by pressure, or incinerate this product. Rotate the adjustment screw with 60 mN·m or less to avoid a risk of damage or fire.
- When disposing of the product, treat as industrial waste.
- If you notice an abnormal condition such as a strange odor, extreme heating of the unit, or smoke, immediately stop using the product, turn off the power, and consult your dealer.

Precautions for Correct Use

Please observe the following precautions to prevent failure to operate, malfunctions, or undesirable effects on product performance.

- Do not install the product in locations subjected to the following conditions.
 - Surrounding air temperature outside the rating
 - Rapid temperature fluctuations (causing condensation)
 - Relative humidity outside the range of 35 to 85%
 - Presence of corrosive or flammable gases
 - Presence of dust, salt, or iron particles
 - Direct vibration or shock
 - Reflection of intense light (such as other laser beams, electric arc-welding machines, or ultra-violet light)
 - Direct sunlight or near heaters
 - Water, oil, or chemical fumes or spray, or mist atmospheres
 - Strong magnetic or electric field
- The circuitry is not stable immediately after turning the power ON, and the values gradually change until the Sensor Head is completely warmed up.
- Always turn off the power of the unit before connecting or disconnecting cables.
- Do not use thinner, alcohol, benzene, acetone, or kerosene to clean the sensor.
- If considerable foreign matter or dust collects on the front of sensor, use a blower brush (for camera lenses) to blow off the foreign matter. Avoid blowing it off with your breath. For a small amount of foreign matter or dust, gently wipe with a soft cloth. Do not wipe hard. If the surface is damaged, false detection may result.
- The product cannot accurately measure the following types of objects: Transparent objects, objects with an extremely low reflective sensor ratio, objects smaller than the spot diameter, objects with a large curvature, excessively inclined objects, etc.
- Do not use the Sensor in water, rainfall, or outdoors.
-  Dispose in accordance with applicable regulations.

Focus Adjustment

The focus of the beam can be adjusted according to the sensing distance by turning the focus adjustment screw.

(E3C-LD11N)

The beam will focus farther away if the screw is turned counterclockwise and closer if the screw is turned clockwise.

(E3C-LD11N+E39-P11)

The beam width will decrease if the screw is turned counterclockwise and increase if the screw is turned clockwise.

(E3C-LD11N+E39-P21)

The beam area will decrease if the screw is turned counterclockwise and increase if the screw is turned clockwise.

(E3C-LR11N)

The beam will focus farther away if the screw is turned counterclockwise and closer if the screw is turned clockwise. Turn the focus adjustment screw with a force of 60 mN·m or less. Turning the adjustment screw with greater force may damage it.

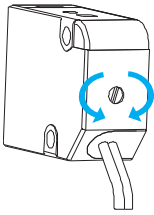

Turn the focus adjustment screw with a force of 60 mN·m or less. Turning the adjustment screw with greater force may damage it.

Optical Axis Alignment

The beam emission angle can be adjusted by turning the optical axis alignment screw.

If the alignment screw is turned clockwise approximately 45°, the beam axis will shift to the left with the following values.

E3C-LD11N: Approximately 2°

E3C-LR11N: Approximately 1.5°

E3C-LR12N: Approximately 1.0°

If the alignment screw is turned counter clockwise approximately 45°, the beam axis will shift to the right with the following values.

E3C-LD11N: Approximately 2°

E3C-LR11N: Approximately 1.5°

E3C-LR12N: Approximately 1.0°

If the shape of the beam changes when the angle is adjusted, adjust the focus again.

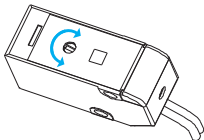

Shortening the Connection Cable

1. Removing the Connector

Using a flat-blade screwdriver, press the lever in the opening next to the cable and then pull out the cable to adjust its length. The tip of the screwdriver must be 2 mm or less in width, and must be of a consistent width to the back of the blade.

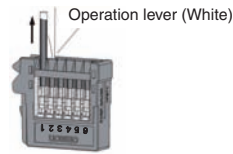

2. Connecting the Connector

- Using the strip gauge on the side of the product, remove 20 mm (max.) of the cladding from the shield wire, strip 7 to 8 mm of the cladding from the conductor, and twist the mesh together several times.

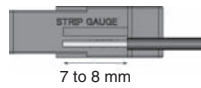

- Insert the wire to the back of the opening. Confirm that the cladding has also entered the opening and that the end of the conductor has passed through the contact section.

Connect as follows:

Terminal 1: Red shield, Terminal 2: Red line, Terminal 5: White line, Terminal 6: White shield.

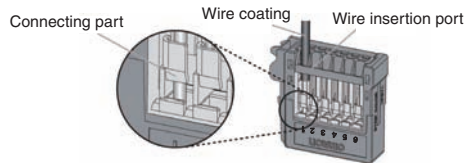

- Insert a flat-blade screwdriver into the release hole and move it up and down gently. When you feel it catch, lift it toward the wire opening. You should be able to hear the operation lever reset.

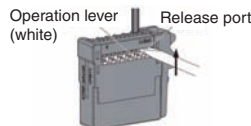

- Confirm that the operation lever has reset and that the cladding is in the insertion opening. (Pull lightly on the line. If you feel resistance, then the connection is okay.)

Refer to XN2 on your OMRON website for details of connecting the connector.

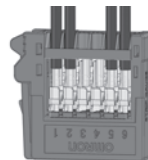

Laser Safety

Handling precautions

1. The E3C-LD11N/E3C-LR11N emits a visible laser beam. Never stare into the beam. Be sure that the end of the beam path is terminated. The best material for terminating the beam is a surface painted with matt paint. If there are reflective surfaces in the beam path, be sure that the reflected beam path is contained. If containment is not possible for the application, do not allow the beam to travel at eye level.
2. Laser safety measures for laser devices are stipulated both in Japan and overseas. Here, two cases are described: Application in Japan and Application in a device to be shipped overseas.

1. Application in Japan

According to JIS C6802, the safety measures required of the user are stipulated according to the class of the laser device. The E3C-LD11N/E3C-LR11N is classified as a class-2 laser according to JIS C6802.

Laser Stickers

The following stickers are attached to the side of the sensor.

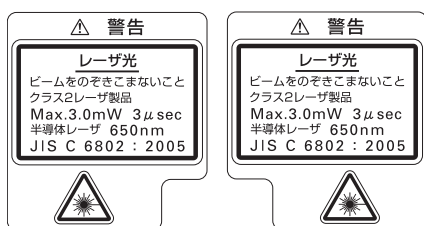

2. USA

When a laser device is exported to the USA, it falls under the laser regulations of the FDA (Food and Drug Administration). The E3C-LD11N/E3C-LR□□N are classified as a class-II laser by the FDA, and it has already been registered with the CDRH (Center for Devices and Radiological Health). Ask your OMRON representative for details.

Laser Labels

Technical standards have been provided with the product. When exporting to the USA, refer to the following illustration and replace the label with the caution label. It is assumed that the E3C-LD11N/E3C-LR□□N will be incorporated into a final system device. When incorporating the E3C-LD11N/E3C-LR□□N, comply with the following technical standards: US Federal Law 21 CFR 1040.10 and 1040.11.

Aperture Label

AVOID
EXPOSURE
Laser Radiation
is emitted from
this aperture

Caution Label

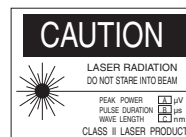

Certification and Identification Label

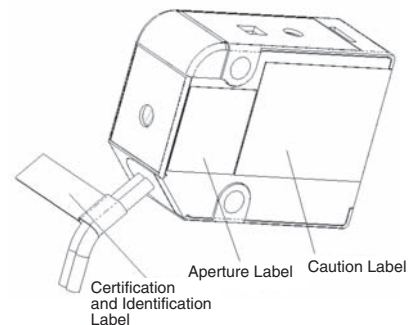

3. Other Countries

- When exporting to countries other than the USA, replace the Japanese warning labels with the English ones provided.
- When exporting to Europe, labels fall under EU standard EN60825-1.

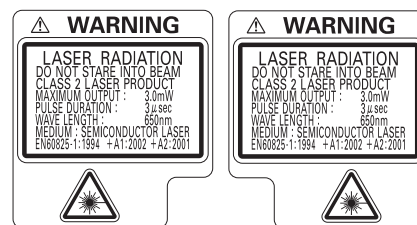

Amplifier Units

WARNING

This product is not designed or rated for ensuring safety of persons either directly or indirectly. Do not use it for such purposes.



Do not use the product with voltage in excess of the rated voltage. Excess voltage may result in malfunction or fire.



Never use the product with an AC power supply. Otherwise, explosion may result.



Precautions for Safe Use

The following precautions must be observed to ensure safe operation of the Amplifier Unit. Doing so may cause damage or fire.

1. Do not install the product in the following locations.
 - Locations subject to direct sunlight
 - Locations subject to condensation due to high humidity
 - Locations subject to corrosive gas
 - Locations subject to vibration or mechanical shocks exceeding the rated values
 - Locations subject to exposure to water, oil, chemicals
 - Locations subject to stream
 - Locations subjected to strong magnetic field or electric field
2. Do not use the product in environments subject to flammable or explosive gases.
3. Do not use the product in any atmosphere or environment that exceeds the ratings.
4. To secure the safety of operation and maintenance, do not install the product close to high-voltage devices and power devices.
5. High-voltage lines and power lines must be wired separately from the product. Wiring them together or placing them in the same duct may cause induction, resulting in malfunction or damage.
6. Do not apply any load exceeding the ratings. Otherwise, damage or fire may result.
7. Do not short the load. Otherwise, damage or fire may result.
8. Connect the load correctly.
9. To use this device as connecting with each other, be sure to connect with the same power supply and turn ON the power simultaneously. Using a separate power supply will influence the functions when connecting the devices to use them.
10. Do not use the product if the case is damaged.
11. Burn injury may occur. The product surface temperature rises depending on application conditions, such as the ambient temperature and the power supply voltage. Attention must be paid during operation or cleaning.
12. When setting the sensor, be sure to check safety such as by stopping the equipment.
13. Be sure to turn off the power supply before connecting or disconnecting wires.
14. Do not attempt to disassemble, repair, or modify the product in any way.
15. When disposing of the product, treat it as industrial waste.
16. Do not use the Sensor in water, rainfall, or outdoors.
17. If you notice any abnormal condition, immediately stop using the product, turn off the power and consult your dealer without doing any operation such as initialization.
18. Sensor heads other than those for E3C-LDA□□N cannot be used. It may be damaged if connected.

Precautions for Correct Use

1. Do not miswire such as the polarity of the power supply.
2. Be sure to mount the unit to the DIN track until it clicks.
3. When using a connector type product, place a protective label (provided with the E3X-CN series) on the power supply connecting terminals that are not used, to prevent electric shock or short circuit.

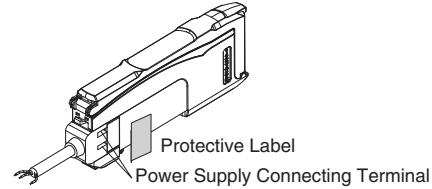

4. The length for the cable extension must be 30 m or less. Be sure to use a cable of at least 0.3 mm² for extension.
5. Do not apply the forces on the cord exceeding the following limits: Pull: 40 N; torque: 0.1 N·m; pressure: 20 N; bending: 29.4 N
6. Do not apply excessive force such as tension, compression or torsion to the connector of the sensor head that is fixed to the amplifier unit.
7. Always keep the protective cover in place when using the product. Not doing so may cause malfunction.
8. It may take time until the received light intensity and measured value become stable immediately after the power is turned on depending on use environment.
9. The product is ready to operate 300 ms after the power supply is turned ON.
10. The Mobile Console E3X-MC11, E3X-MC11-SV2 and E3X-MC11-S cannot be connected.
11. The mutual interference prevention function works when between E3C-LDAN. The mutual interference will occur if other amplifier units are used.
12. Sensor heads other than those for E3C-LDAN cannot be used. It may be damaged if connected.
13. If the unit receives excessive sensor light, the mutual interference prevention function may not work properly, resulting in malfunction of the unit. In such case, increase the threshold.
14. The Communication Unit E3X-DRT21-S, E3X-CRT, E3X-ECT and E3NW cannot be connected.
15. Do not use thinner, benzene, acetone, and lamp oil for cleaning.
16. The amplifier unit uses EEPROM memory to save the configuration information. If the memory rewritable time exceeds its limit (100,000 times), the memory error will be displayed and the amplifier unit needs to be replaced. Memory data is rewritten, for each operation, three times when tuning, processing zero reset, and changing the hysteresis width, and ten times when initializing the settings.
17.  If a crossed out wheellie bin symbol is labeled on the amplifier unit, dispose in accordance with applicable regulations.

Mounting

Mounting and removing the sensor head

1. Open the protective cover.
2. With the locking lever on the sensor head connector facing up, insert the connector into the connector opening.

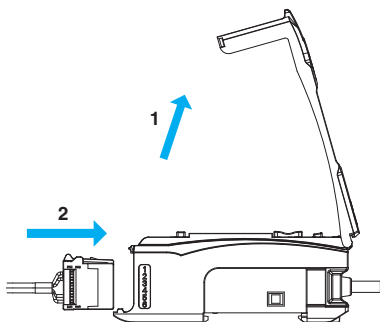

To remove the connector, press down on the locking lever and pull the connector out.

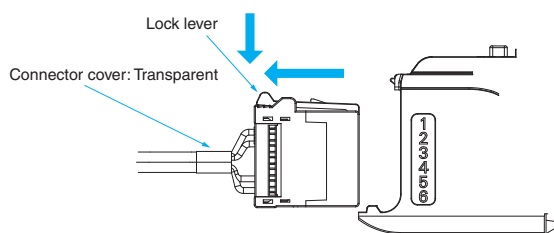

Connecting and Disconnecting Connectors

(Mounting Connectors)

Insert the Master or Slave Connector into the Amplifier Unit until it clicks into place.

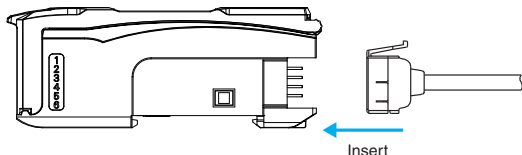

(Removing Connectors)

1. Slide the slave Amplifier Unit(s) for which the Connector is to be removed away from the rest of the group.
2. After the Amplifier Unit(s) has been separated, press down on the lever on the Connector and remove it. (Do not attempt to remove Connectors without separating them from other Amplifier Units first.)

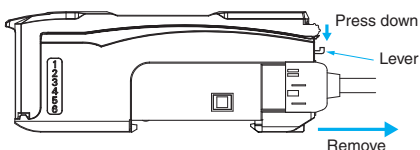

Mounting, Removing and Joining Amplifier Units

(Mounting on DIN Track)

1. Let the hook on the Amplifier Unit's Sensor Head connection side catch the track.
2. Push the unit until the hook clicks into place.

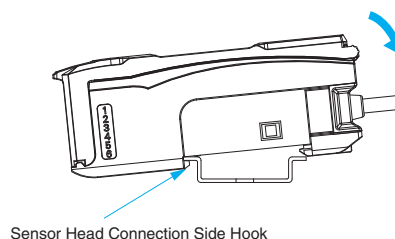

(Removing from DIN Track)

1. Push the unit in the direction 1.
2. Lift the unit in the direction of arrow 2 while performing step (1). (Do not attempt to remove Amplifier Units from the DIN track without separating them first.)

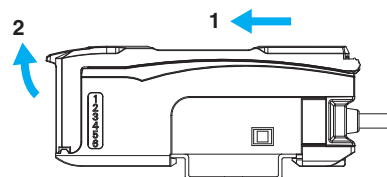

(Joining Amplifier Units)

1. Mount the Amplifier Units one at a time onto the DIN track.
2. When using a wire-saving connector, mount the master connector to A and slave connector to B.
3. Slide the Amplifier Unit until the Amplifier Unit is closely attached. (Arrow 3) (For the wire-saving connector type, be sure that a master connector and a slave connector, or a slave connector and a slave connector are connected.)
4. Use End Plates (PFP-M: separately sold) at the both ends of the grouped Amplifier Units to prevent them from separating due to vibration or other cause. (Arrow 4)
5. Tighten the screw on the End Plates using a driver. (Arrow 5)

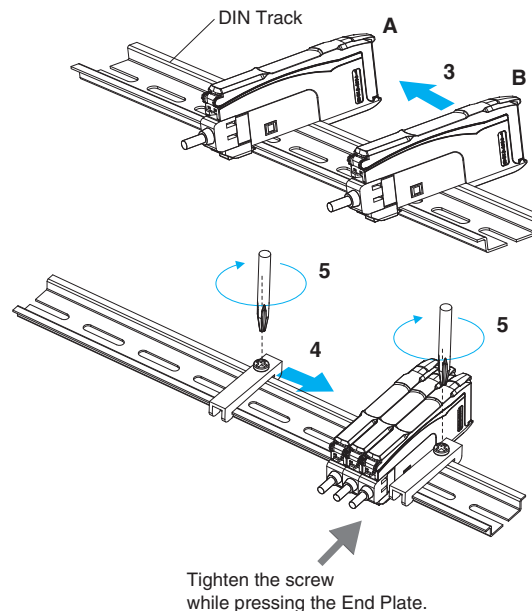

E3C-LDA□N

Dimensions

(Unit: mm)

Tolerance class IT16 applies to dimensions in this data sheet unless otherwise specified.

Sensor Heads

E3C-LD11N

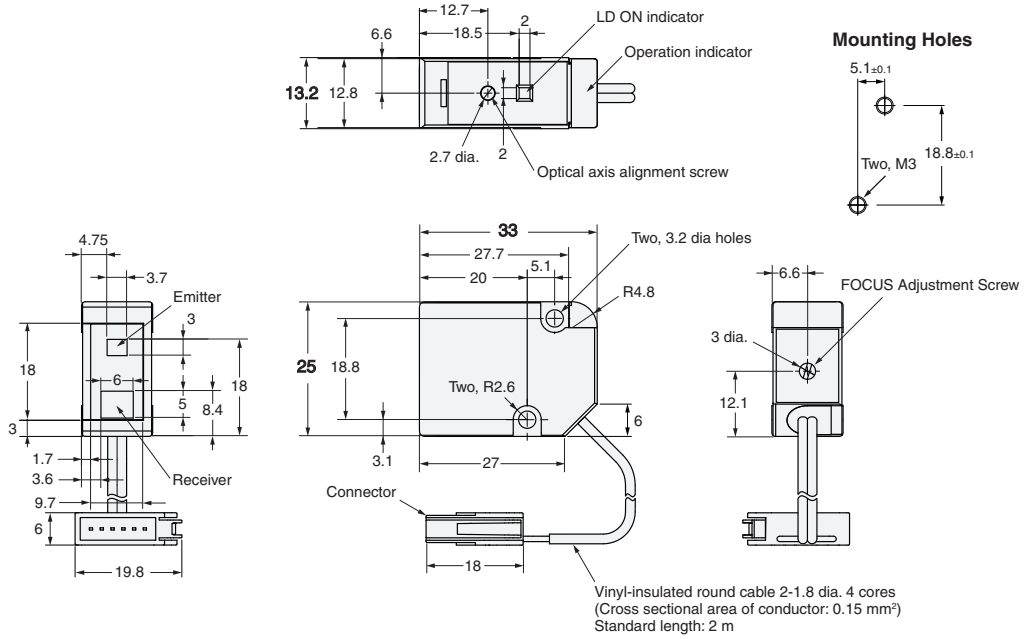

With E39-P11/E39-P21 Beam Unit Attached

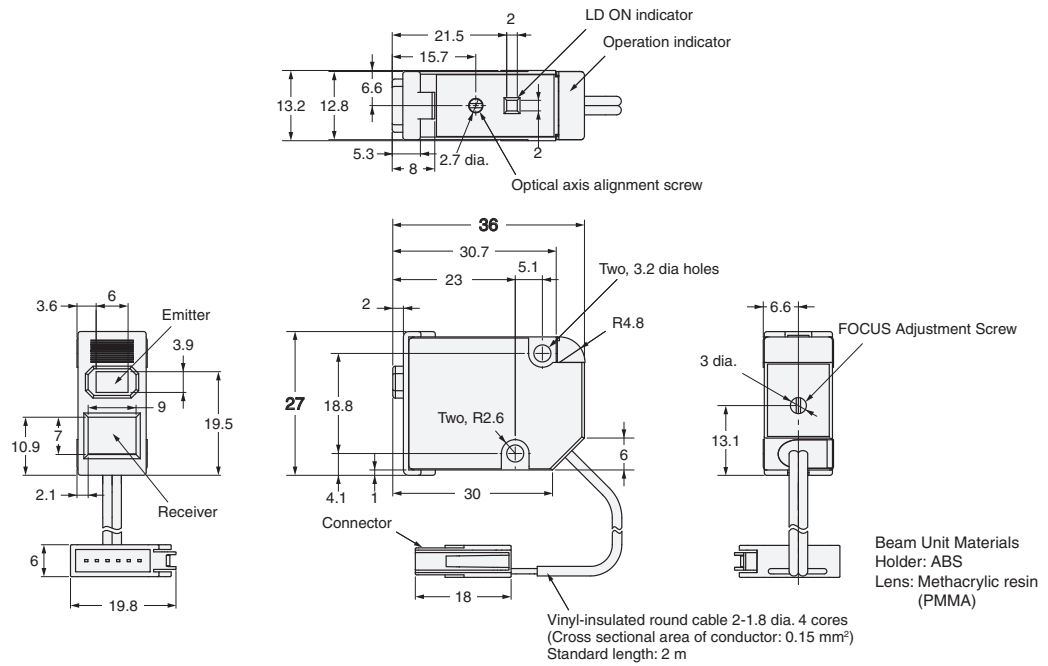

E3C-LR11N
E3C-LR12N

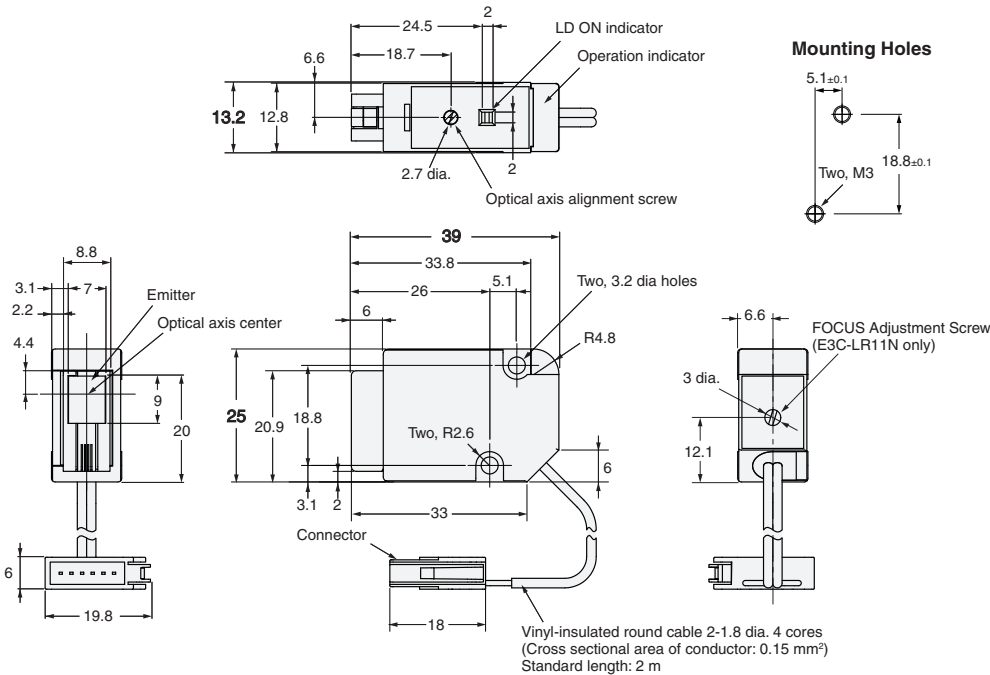

With E39-P11/E39-P21 Beam Unit Attached

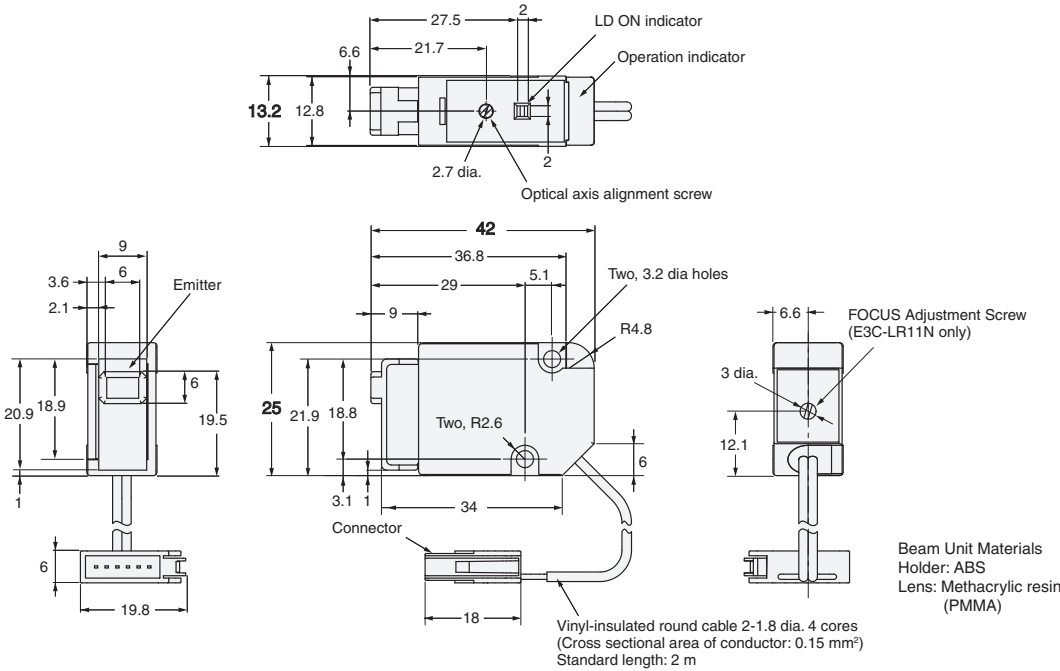

Note: The Beam Unit (E39-P31/E39-P41) can be attached only to the E3C-LR11N.

Amplifier Units

Pre-wired Amplifier Units E3C-LDA21N E3C-LDA51N

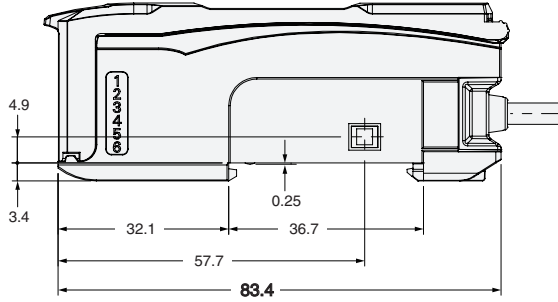
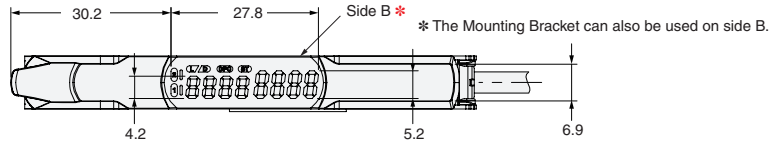

Mounted to DIN Track

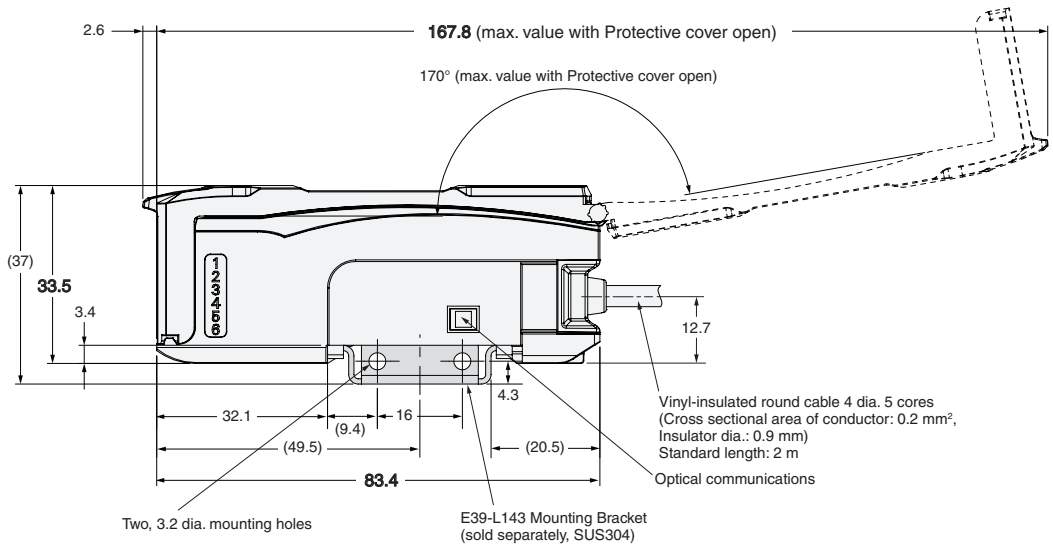
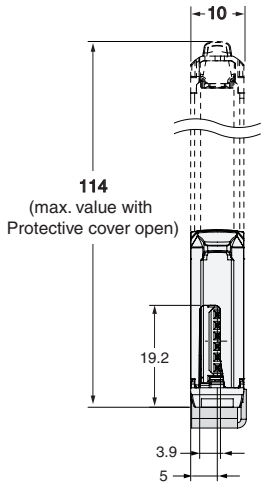

Mounting Holes

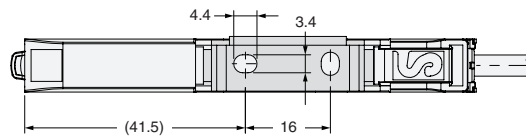
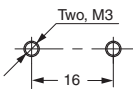

Amplifier Units with Wire-saving Connectors

- E3C-LDA6N
- E3C-LDA7N
- E3C-LDA8N
- E3C-LDA9N



E3C-LDA6N/LDA8N

E3C-LDA7N/LDA9N

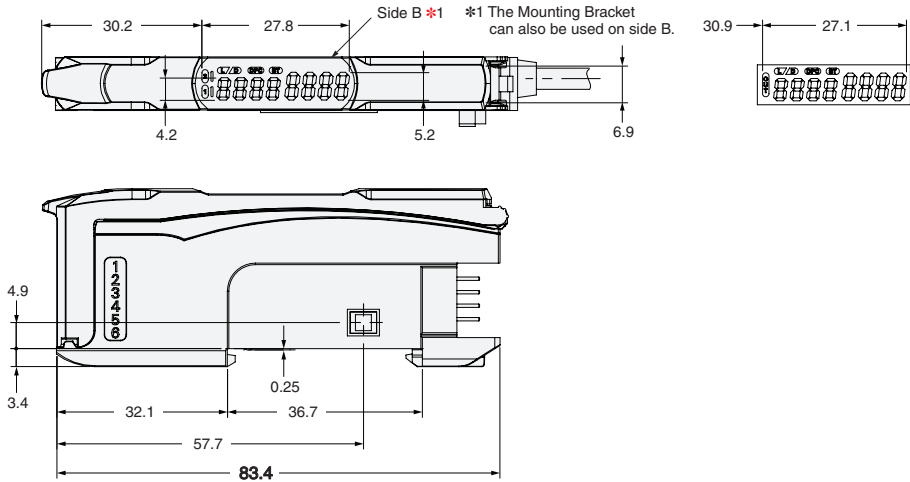

Mounted to DIN Track

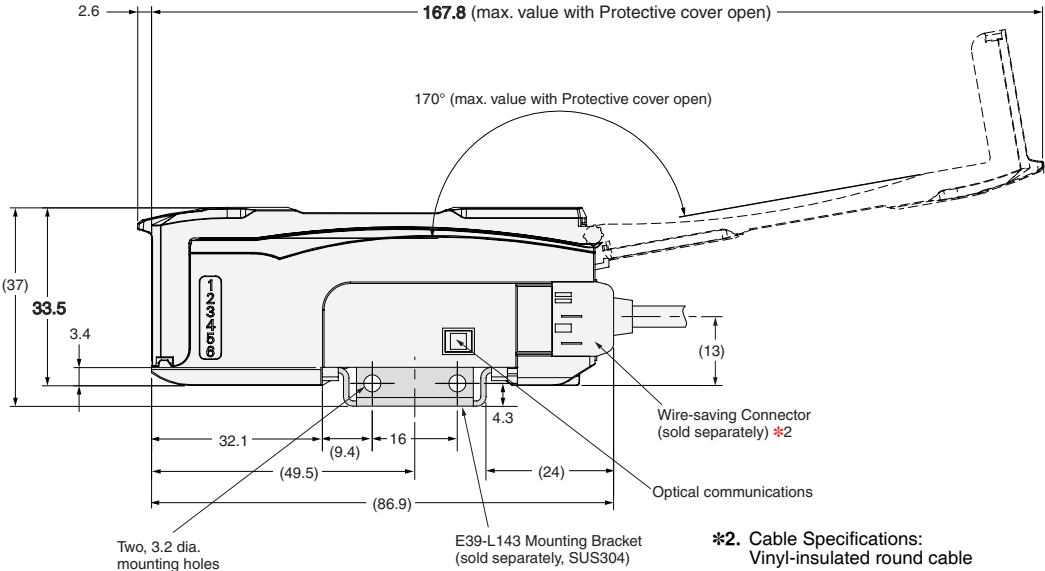
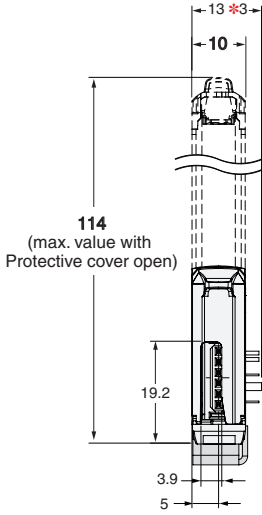

Mounting Holes

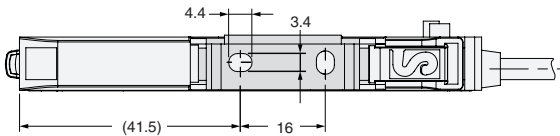
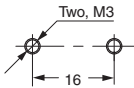

*2. Cable Specifications:
Vinyl-insulated round cable

Model	Outer diameter	No. of conductors
E3X-CN21	4.0 dia.	4
E3X-CN22		2

*3. With E3X-CN22 Connected

Accessories (Sold Separately)

Wire-saving Connectors

Master Connector E3X-CN21

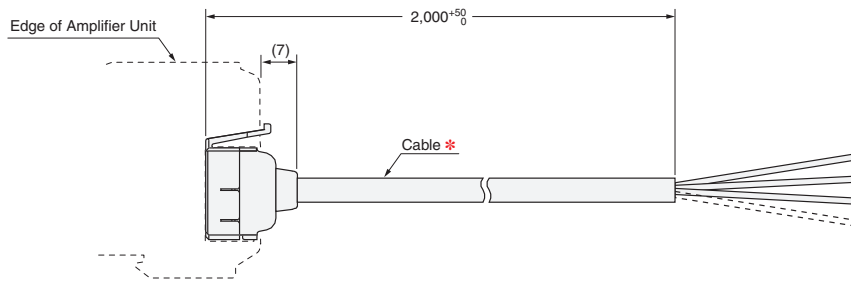

* Cable: 4-dia. cable with 4 conductors, Standard cable length: 2 m (Conductor cross-section: 0.2 mm² (AWG24), Insulator diameter: 1.1 mm)

Slave Connector E3X-CN22

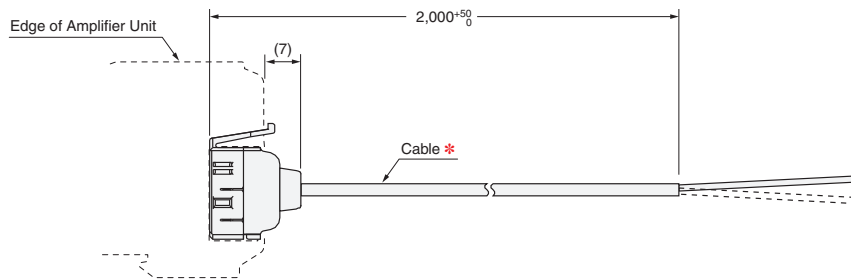

* Cable: 4-dia. cable with 2 conductors, Standard cable length: 2 m (Conductor cross-section: 0.2 mm² (AWG24), Insulator diameter: 1.1 mm)

Terms and Conditions Agreement

Read and understand this catalog.

Please read and understand this catalog before purchasing the products. Please consult your OMRON representative if you have any questions or comments.

Warranties.

(a) Exclusive Warranty. Omron's exclusive warranty is that the Products will be free from defects in materials and workmanship for a period of twelve months from the date of sale by Omron (or such other period expressed in writing by Omron). Omron disclaims all other warranties, express or implied.

(b) Limitations. OMRON MAKES NO WARRANTY OR REPRESENTATION, EXPRESS OR IMPLIED, ABOUT NON-INFRINGEMENT, MERCHANTABILITY OR FITNESS FOR A PARTICULAR PURPOSE OF THE PRODUCTS. BUYER ACKNOWLEDGES THAT IT ALONE HAS DETERMINED THAT THE PRODUCTS WILL SUITABLY MEET THE REQUIREMENTS OF THEIR INTENDED USE.

Omron further disclaims all warranties and responsibility of any type for claims or expenses based on infringement by the Products or otherwise of any intellectual property right. (c) Buyer Remedy. Omron's sole obligation hereunder shall be, at Omron's election, to (i) replace (in the form originally shipped with Buyer responsible for labor charges for removal or replacement thereof) the non-complying Product, (ii) repair the non-complying Product, or (iii) repay or credit Buyer an amount equal to the purchase price of the non-complying Product; provided that in no event shall Omron be responsible for warranty, repair, indemnity or any other claims or expenses regarding the Products unless Omron's analysis confirms that the Products were properly handled, stored, installed and maintained and not subject to contamination, abuse, misuse or inappropriate modification. Return of any Products by Buyer must be approved in writing by Omron before shipment. Omron Companies shall not be liable for the suitability or unsuitability or the results from the use of Products in combination with any electrical or electronic components, circuits, system assemblies or any other materials or substances or environments. Any advice, recommendations or information given orally or in writing, are not to be construed as an amendment or addition to the above warranty.

See <http://www.omron.com/global/> or contact your Omron representative for published information.

Limitation on Liability; Etc.

OMRON COMPANIES SHALL NOT BE LIABLE FOR SPECIAL, INDIRECT, INCIDENTAL, OR CONSEQUENTIAL DAMAGES, LOSS OF PROFITS OR PRODUCTION OR COMMERCIAL LOSS IN ANY WAY CONNECTED WITH THE PRODUCTS, WHETHER SUCH CLAIM IS BASED IN CONTRACT, WARRANTY, NEGLIGENCE OR STRICT LIABILITY.

Further, in no event shall liability of Omron Companies exceed the individual price of the Product on which liability is asserted.

Suitability of Use.

Omron Companies shall not be responsible for conformity with any standards, codes or regulations which apply to the combination of the Product in the Buyer's application or use of the Product. At Buyer's request, Omron will provide applicable third party certification documents identifying ratings and limitations of use which apply to the Product. This information by itself is not sufficient for a complete determination of the suitability of the Product in combination with the end product, machine, system, or other application or use. Buyer shall be solely responsible for determining appropriateness of the particular Product with respect to Buyer's application, product or system. Buyer shall take application responsibility in all cases.

NEVER USE THE PRODUCT FOR AN APPLICATION INVOLVING SERIOUS RISK TO LIFE OR PROPERTY OR IN LARGE QUANTITIES WITHOUT ENSURING THAT THE SYSTEM AS A WHOLE HAS BEEN DESIGNED TO ADDRESS THE RISKS, AND THAT THE OMRON PRODUCT(S) IS PROPERLY RATED AND INSTALLED FOR THE INTENDED USE WITHIN THE OVERALL EQUIPMENT OR SYSTEM.

Programmable Products.

Omron Companies shall not be responsible for the user's programming of a programmable Product, or any consequence thereof.

Performance Data.

Data presented in Omron Company websites, catalogs and other materials is provided as a guide for the user in determining suitability and does not constitute a warranty. It may represent the result of Omron's test conditions, and the user must correlate it to actual application requirements. Actual performance is subject to the Omron's Warranty and Limitations of Liability.

Change in Specifications.

Product specifications and accessories may be changed at any time based on improvements and other reasons. It is our practice to change part numbers when published ratings or features are changed, or when significant construction changes are made. However, some specifications of the Product may be changed without any notice. When in doubt, special part numbers may be assigned to fix or establish key specifications for your application. Please consult with your Omron's representative at any time to confirm actual specifications of purchased Product.

Errors and Omissions.

Information presented by Omron Companies has been checked and is believed to be accurate; however, no responsibility is assumed for clerical, typographical or proofreading errors or omissions.

Note: Do not use this document to operate the Unit.

OMRON Corporation Industrial Automation Company
Kyoto, JAPAN

Contact: www.ia.omron.com

Regional Headquarters

OMRON EUROPE B.V.

Wegalaan 67-69, 2132 JD Hoofddorp
The Netherlands
Tel: (31)2356-81-300/Fax: (31)2356-81-388

OMRON ELECTRONICS LLC

2895 Greenspoint Parkway, Suite 200
Hoffman Estates, IL 60169 U.S.A.
Tel: (1) 847-843-7900/Fax: (1) 847-843-7787

OMRON ASIA PACIFIC PTE. LTD.

No. 438A Alexandra Road # 05-05/08 (Lobby 2),
Alexandra Technopark,
Singapore 119967
Tel: (65) 6835-3011/Fax: (65) 6835-2711

OMRON (CHINA) CO., LTD.

Room 2211, Bank of China Tower,
200 Yin Cheng Zhong Road,
PuDong New Area, Shanghai, 200120, China
Tel: (86) 21-5037-2222/Fax: (86) 21-5037-2200

Authorized Distributor:

© OMRON Corporation 2022. All Rights Reserved.
In the interest of product improvement,
specifications are subject to change without notice.

Cat. No. E605-E1-01

0222 (0222)